



M4T28-BR12SH
M4T32-BR12SH

TIMEKEEPER[®] SNAPHAT[®] (battery and crystal)

Features

- Provides battery backup power for non-volatile TIMEKEEPER[®] and supervisor devices in the 28- or 44-pin SNAPHAT[®] SOIC package
- Removable battery avoids heat associated with surface mount process
- Snaps directly onto surface-mounted SNAPHAT SOIC
- Choice of battery capacities:
 - M4T28-BR12SH = 48 mAh
 - M4T32-BR12SH = 120 mAh
- Keyed insertion to ensure proper assembly
- Removable for replacement and proper disposal
- Pb-free package
- Available in Ecopack[®] packages, tubes or tape & reel

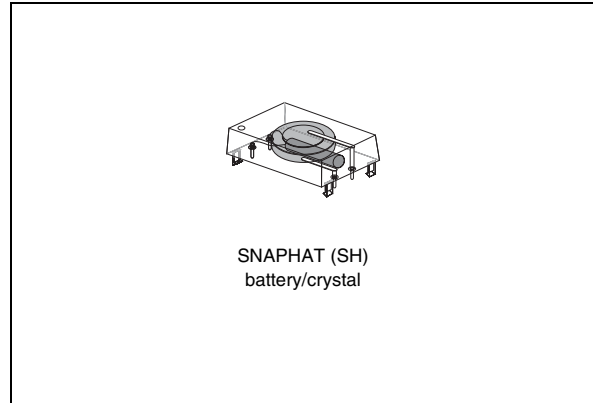

KTTIC

Contents

- 1 **Description** 5
- 2 **Maximum ratings** 6
- 3 **DC and AC parameters** 7
- 4 **Mechanical information** 8
 - 4.1 Battery characteristics 9
 - 4.2 UL recognition 9
 - 4.3 Battery life 9
 - 4.4 General notes 9
- 5 **Package mechanical data** 11
- 6 **Part numbering** 13
- 7 **Environmental information** 14
- 8 **Revision history** 15

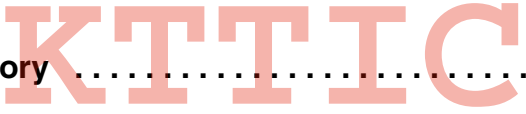

List of tables

Table 1. Signal names 5
Table 2. Absolute maximum ratings 6
Table 3. Operating and AC measurement conditions 7
Table 4. SH – 4-pin SNAPHAT® housing for 48 mAh battery & crystal, package mechanical data 11
Table 5. SH – 4-pin SNAPHAT® housing for 120 mAh battery & crystal,
package mechanical data 12
Table 6. Ordering information scheme 13
Table 7. Document revision history 15



List of figures

Figure 1. Logic diagram 5
Figure 2. SNAPHAT® insertion/extraction forces 8
Figure 3. Battery discharge rates 10
Figure 4. DIP extractor tool 10
Figure 5. SH – 4-pin SNAPHAT® housing for 48 mAh battery & crystal, package outline 11
Figure 6. SH – 4-pin SNAPHAT® housing for 120 mAh battery & crystal, package outline 12
Figure 7. Recycling symbols 14



1 Description

The M4TXX-BR12SH SNAPHAT[®] top is a detachable lithium power source for ST's non-volatile TIMEKEEPER[®] surface-mount SOIC (MH) package (28- and 44-pin).

The SNAPHAT top contains both the battery and crystal and is designed to be “snapped on” after the SOIC is surface mounted on the PC board. Thus the two piece solution prevents the battery and crystal from being exposed to the high temperatures of the surface mount process.

Figure 1. Logic diagram

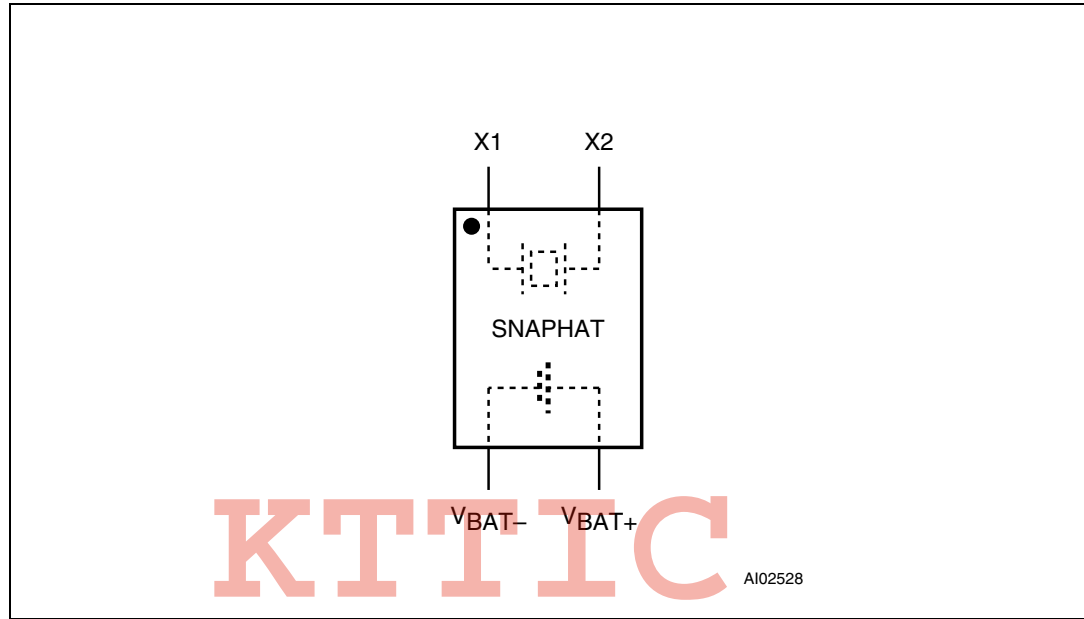

Table 1. Signal names

X1	Crystal input
X2	Crystal output
V _{BAT-}	Negative voltage
V _{BAT+}	Positive voltage

2 Maximum ratings

Stressing the device above the rating listed in the absolute maximum ratings table may cause permanent damage to the device. These are stress ratings only and operation of the device at these or any other conditions above those indicated in the operating sections of this specification is not implied. Exposure to absolute maximum rating conditions for extended periods may affect device reliability. Refer also to the STMicroelectronics SURE program and other relevant quality documents.

Table 2. Absolute maximum ratings

Symbol	Parameter	Value	Unit	
T_A	Ambient operating temperature	Grade 1	0 to 70	°C
		Grade 6 ⁽¹⁾	-40 to 85	°C
T_{STG}	Storage temperature (V_{CC} off, oscillator off)	-40 to 85	°C	

1. Only the M4T32-BR12SH is available in industrial temperature (grade 6).

Caution: *Do NOT wave solder SOIC to avoid damaging SNAPHAT sockets.*

KTTIC

3 DC and AC parameters

This section summarizes the operating and measurement conditions, as well as the DC and AC characteristics of the device. The parameters in the following DC and AC characteristic tables are derived from tests performed under the measurement conditions listed in the relevant tables. Designers should check that the operating conditions in their projects match the measurement conditions when using the quoted parameters.

Table 3. Operating and AC measurement conditions

Parameter	M4T28-BR12SH	M4T32-BR12SH	Unit
Nominal battery voltage (V_{CC})	2.8	2.8	V
Nominal battery capacity	48	120	mAh
Battery chemistry	Li(CF)	Li(CF)	
Crystal load capacitance (C_L)	12.5	12.5	pF
Nominal crystal frequency	32.768	32.768	kHz
Crystal accuracy (at 25°C)	± 35	± 35	ppm

KTTIC

4 Mechanical information

Electrical connection to the SOIC is made through four pins that connect to the four press fitted sockets at each end of the SOIC. Critical contact points between the pins and sockets are gold-plated to resist oxidation. Internally, each socket contains six independent contact fingers to form redundant connections between the two components. These sockets were designed with high point contact force to provide the lowest possible contact resistance. The SNAPHAT[®] top also incorporates four molded-in retaining clips which hold onto the ends of the SOIC insuring mechanical and electrical connection even under severe mechanical shock and vibration. The combined SOIC and SNAPHAT assembly can sustain shock levels in excess of 100 g without separating. This package also passes variable frequency testing in accordance with MIL-STD-883, method 2007.2, condition A.

Figure 2 illustrates the affect of repeated insertion and extraction of the SNAPHAT top to the SOIC. The force required to extract the SNAPHAT, and then to re-insert it, reduces each time. After four or five extractions, the reduction starts to become unnoticeable and the force required remains at a fairly constant figure. Typically, though, the SNAPHAT will only need to be extracted and re-inserted once in its lifetime.

Figure 2. SNAPHAT[®] insertion/extraction forces

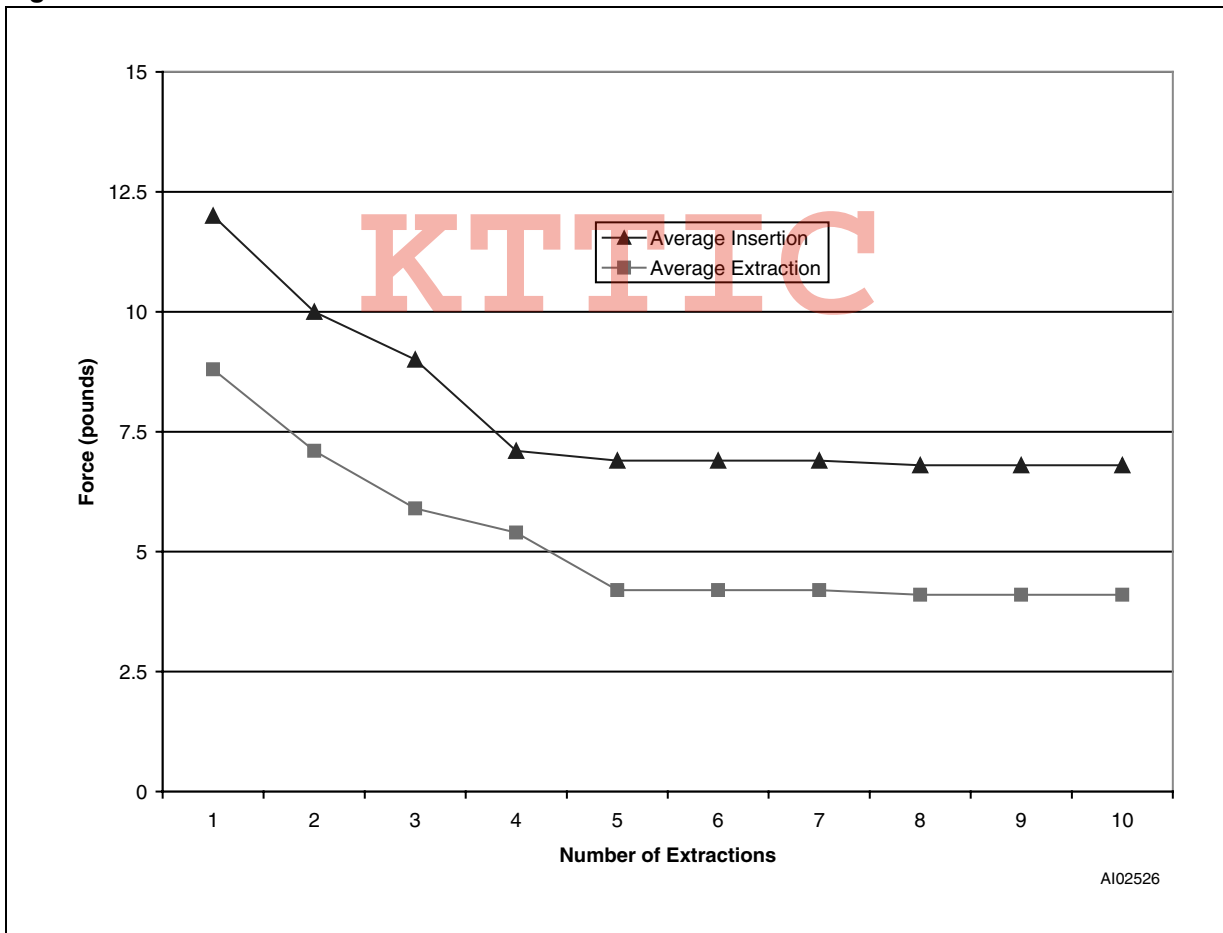

4.1 Battery characteristics

Figure 3 on page 10 illustrates the lithium coin cell discharge rate for a given load. This demonstrates the characteristically flat voltage level supplied by the battery until very near the end of its life. These discharge levels have been greatly accelerated in comparison to the normal, actual usage.

Note: These batteries contain no mercury (Hg), cadmium (Cd), or lead (Pb).

4.2 UL recognition

The M4Txx-BR12SH has been recognized by Underwriters Laboratories under their Component Recognition Program and carries U.L. File Number E89556.

4.3 Battery life

For information on data retention life and battery storage life, please refer to the application note AN1012.

4.4 General notes

ST has conducted experiments using a manual press which determined that if approximately 60 pounds of force is applied to the top of the SNAPHAT[®], battery damage and/or die cracks could be induced. As *Figure 2 on page 8* specifies, only an average of less than 13 force-pounds is required for proper insertion. We recommend that no more than 40 pounds of force be applied during SNAPHAT insertion.

If a manual press is employed, it is very important that it be calibrated such that it cannot exceed this limit.

To remove the SNAPHAT top for replacement, a DIP/IC extractor tool should be used (see *Figure 4*). The SNAPHAT top should be grabbed by the narrow end to avoid bending the pins.

Caution: To avoid draining battery do NOT place SNAPHAT pins into conductive foam.

Caution: To avoid damaging SNAPHAT sockets do NOT wave solder SOIC.

Figure 3. Battery discharge rates

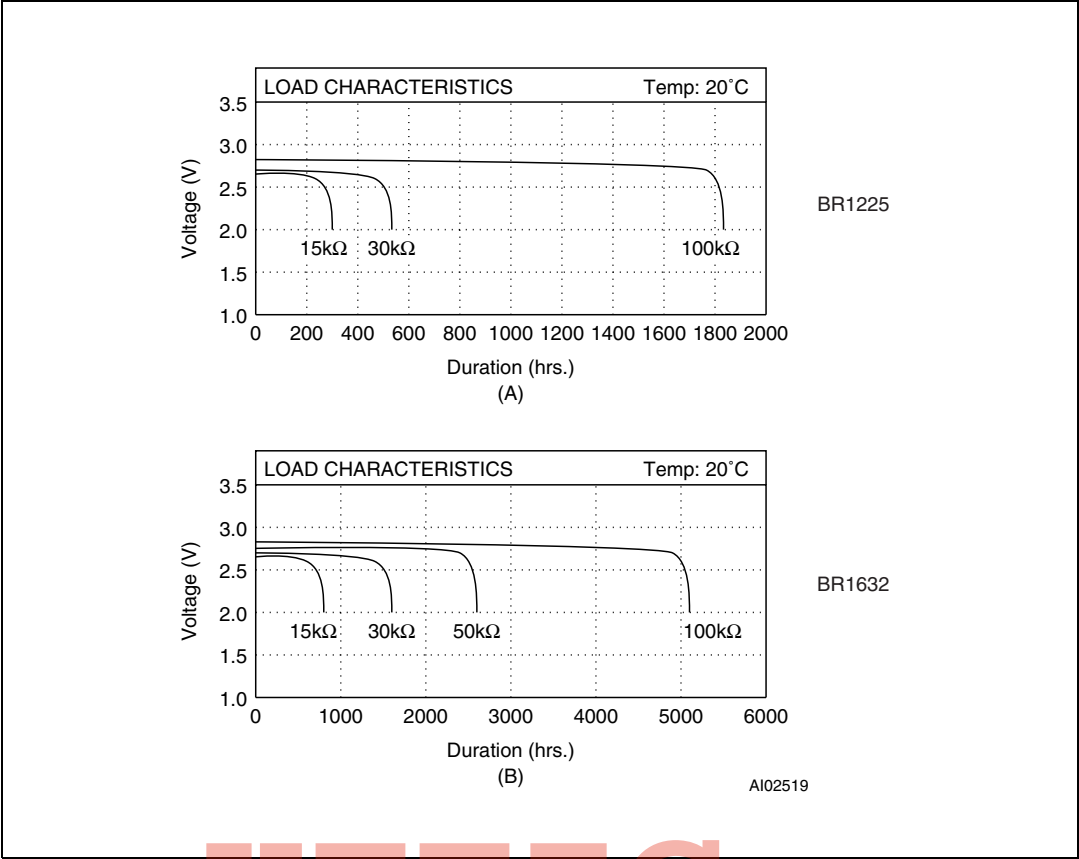
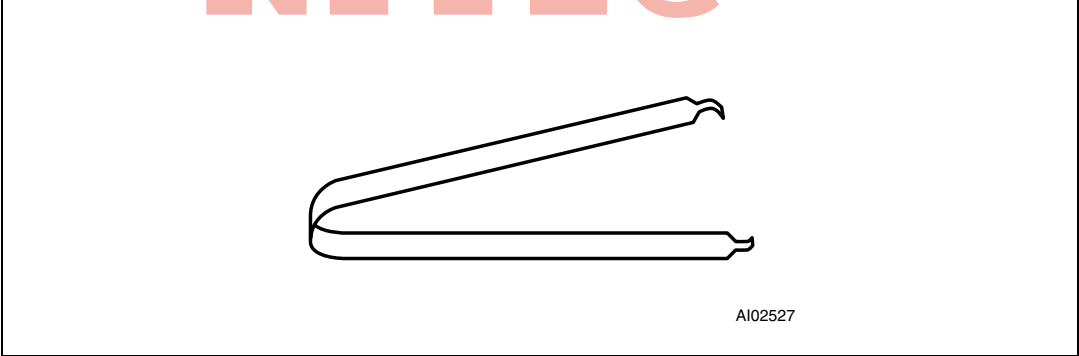

Figure 4. DIP extractor tool



5 Package mechanical data

In order to meet environmental requirements, ST offers these devices in ECOPACK[®] packages. These packages have a lead-free second level interconnect. The category of second level interconnect is marked on the package and on the inner box label, in compliance with JEDEC Standard JESD97. The maximum ratings related to soldering conditions are also marked on the inner box label. ECOPACK is an ST trademark. ECOPACK specifications are available at: www.st.com.

Figure 5. SH – 4-pin SNAPHAT[®] housing for 48 mAh battery & crystal, package outline

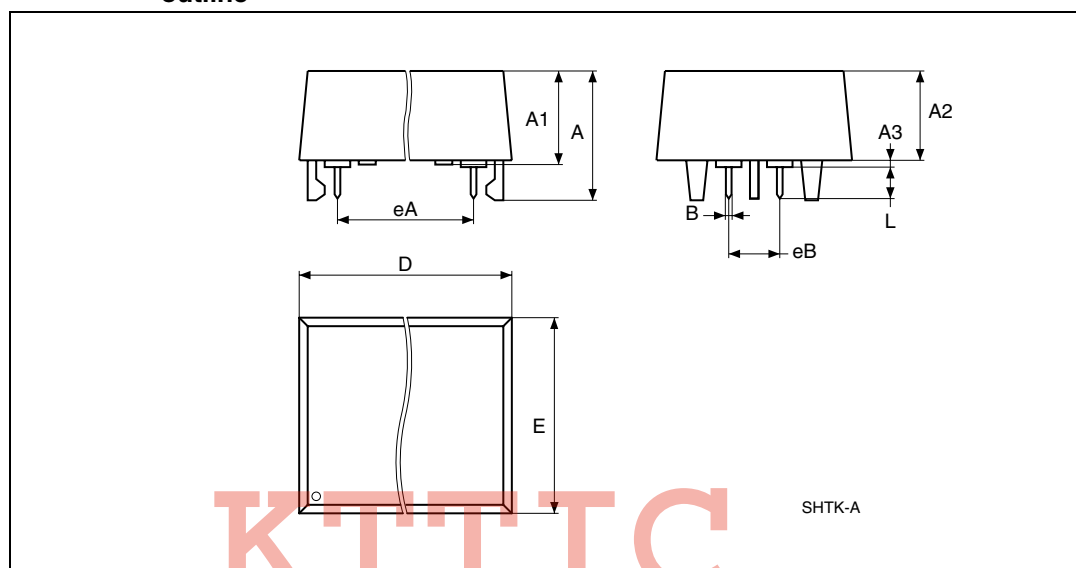

Note: Drawing is not to scale.

Table 4. SH – 4-pin SNAPHAT[®] housing for 48 mAh battery & crystal, package mechanical data

Symb	mm			inches		
	Typ	Min	Max	Typ	Min	Max
A			9.78			0.385
A1		6.73	7.24		0.265	0.285
A2		6.48	6.99		0.255	0.275
A3			0.38			0.015
B		0.46	0.56		0.018	0.022
D		21.21	21.84		0.835	0.860
E		14.22	14.99		0.560	0.590
eA		15.55	15.95		0.612	0.628
eB		3.20	3.61		0.126	0.142
L		2.03	2.29		0.080	0.090

Figure 6. SH – 4-pin SNAPHAT® housing for 120 mAh battery & crystal, package outline

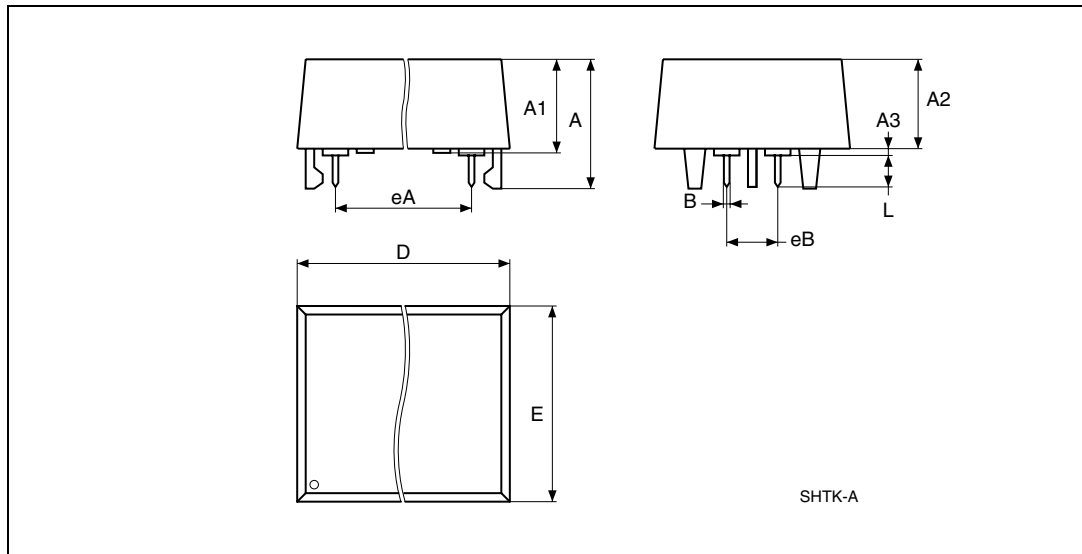

Note: Drawing is not to scale.

Table 5. SH – 4-pin SNAPHAT® housing for 120 mAh battery & crystal, package mechanical data

Symb	mm			inches		
	Typ	Min	Max	Typ	Min	Max
A			10.54			0.415
A1		8.00	8.51		0.315	0.335
A2		7.24	8.00		0.285	0.315
A3			0.38			0.015
B		0.46	0.56		0.018	0.022
D		21.21	21.84		0.835	0.860
E		17.27	18.03		0.680	0.710
eA		15.55	15.95		0.612	0.628
eB		3.20	3.61		0.126	0.142
L		2.03	2.29		0.080	0.090

6 Part numbering

Table 6. Ordering information scheme

Example:	M4T	28-BR12	SH	1	TR
Device type	M4T				
Battery voltage and capacity		28-BR12 = BR1225, 3 V, 48 mAh 32-BR12 = BR1632, 3 V, 120 mAh			
Package			SH = SNAPHAT®		
Temperature range				1 = 0 to 70°C 6 = -40 to 85°C (M4T32-BR12SH only)	
Shipping method					blank = Ecopack® package, tubes TR = Ecopack® package, tape & reel

For a list of available options (e.g., speed, package) or for further information on any aspect of this device, please contact the ST sales office nearest to you.

7 Environmental information

Figure 7. Recycling symbols

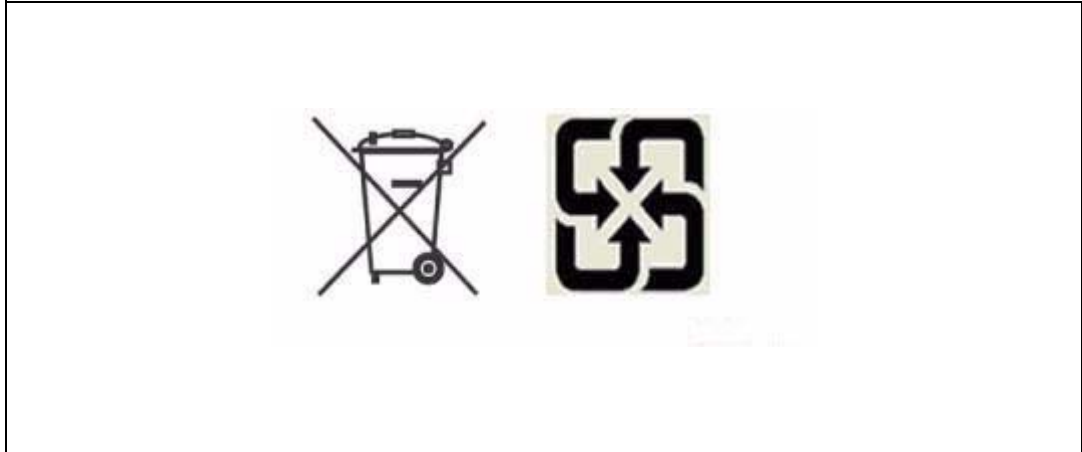

This product contains a non-rechargeable lithium (lithium carbon monofluoride chemistry) button cell battery fully encapsulated in the final product.

Recycle or dispose of batteries in accordance with the battery manufacturer's instructions and local/national disposal and recycling regulations.

Please refer to the following web site address for additional information regarding compliance statements and waste recycling.

Go to www.st.com/nvram, then select "Lithium Battery Recycling" from "Related Topics".

KTTIC

8 Revision history

Table 7. Document revision history

Date	Revision	Changes
Nov-1999	1	First issue
01-Mar-2001	2	Reformatted
04-Jun-2001	2.1	Basic textual changes from reformatting activity
10-Jul-2001	2.2	Changes references to “supervisor” from “controller;” clarify temperature characteristics
21-Jan-2002	2.3	Change to include crystal accuracy (Table 3); add text for SNAPHAT [®] insertion force tolerance and battery characteristics note
20-Aug-2002	2.4	Updated insertion/extraction data (Figure 2)
14-Mar-2003	2.5	Add pb-free note on page 1
20-Nov-2008	3	Reformatted document; updated cover page, Section 5: Package mechanical data , Table 6 ; added Section 7: Environmental information .

KTTIC

Please Read Carefully:

Information in this document is provided solely in connection with ST products. STMicroelectronics NV and its subsidiaries ("ST") reserve the right to make changes, corrections, modifications or improvements, to this document, and the products and services described herein at any time, without notice.

All ST products are sold pursuant to ST's terms and conditions of sale.

Purchasers are solely responsible for the choice, selection and use of the ST products and services described herein, and ST assumes no liability whatsoever relating to the choice, selection or use of the ST products and services described herein.

No license, express or implied, by estoppel or otherwise, to any intellectual property rights is granted under this document. If any part of this document refers to any third party products or services it shall not be deemed a license grant by ST for the use of such third party products or services, or any intellectual property contained therein or considered as a warranty covering the use in any manner whatsoever of such third party products or services or any intellectual property contained therein.

UNLESS OTHERWISE SET FORTH IN ST'S TERMS AND CONDITIONS OF SALE ST DISCLAIMS ANY EXPRESS OR IMPLIED WARRANTY WITH RESPECT TO THE USE AND/OR SALE OF ST PRODUCTS INCLUDING WITHOUT LIMITATION IMPLIED WARRANTIES OF MERCHANTABILITY, FITNESS FOR A PARTICULAR PURPOSE (AND THEIR EQUIVALENTS UNDER THE LAWS OF ANY JURISDICTION), OR INFRINGEMENT OF ANY PATENT, COPYRIGHT OR OTHER INTELLECTUAL PROPERTY RIGHT.

UNLESS EXPRESSLY APPROVED IN WRITING BY AN AUTHORIZED ST REPRESENTATIVE, ST PRODUCTS ARE NOT RECOMMENDED, AUTHORIZED OR WARRANTED FOR USE IN MILITARY, AIR CRAFT, SPACE, LIFE SAVING, OR LIFE SUSTAINING APPLICATIONS, NOR IN PRODUCTS OR SYSTEMS WHERE FAILURE OR MALFUNCTION MAY RESULT IN PERSONAL INJURY, DEATH, OR SEVERE PROPERTY OR ENVIRONMENTAL DAMAGE. ST PRODUCTS WHICH ARE NOT SPECIFIED AS "AUTOMOTIVE GRADE" MAY ONLY BE USED IN AUTOMOTIVE APPLICATIONS AT USER'S OWN RISK.

Resale of ST products with provisions different from the statements and/or technical features set forth in this document shall immediately void any warranty granted by ST for the ST product or service described herein and shall not create or extend in any manner whatsoever, any liability of ST.

ST and the ST logo are trademarks or registered trademarks of ST in various countries.

Information in this document supersedes and replaces all information previously supplied.

The ST logo is a registered trademark of STMicroelectronics. All other names are the property of their respective owners.

© 2008 STMicroelectronics - All rights reserved

STMicroelectronics group of companies

Australia - Belgium - Brazil - Canada - China - Czech Republic - Finland - France - Germany - Hong Kong - India - Israel - Italy - Japan - Malaysia - Malta - Morocco - Singapore - Spain - Sweden - Switzerland - United Kingdom - United States of America

www.st.com