

RSW SERIES



RSW 100/150



RSW 200/300

FEATURES

- * Resonant switchers, power factor correction and main converter
- * Power factor correction up to 0.99, meeting IEC61000-3-2(EN61000-3-2)
- * 85 to 264VAC universal input
- * High efficiency up to 90%
- * Low EMI, meeting FCC B, CISPR B

SAFETY STANDARDS

- UL1950 Recognized
- CSA22.2 No.950 Certified (cUL)
- EN60950 (TUV Certified)
- CE mark (LVD only)

APPLICATIONS

- *Data/information processing equipment
- *FA control equipment
- *Measuring, inspection and testing equipment
- *Communication equipment
- *Optical equipment



RSW SERIES GENERAL SPECIFICATIONS

ITEM	
1	Input voltage range 85V ~ 264VAC
2	Input frequency range 47Hz ~ 63Hz
3	Operating temperature -10 ~ 60 (Refer to Output derating)
4	Operating humidity 30 ~ 90%RH (Non condensing)
5	Storage temperature -30 ~ 85
6	Storage humidity 10 ~ 95%RH (Non condensing)
7	Cooling Convection or forced air cooling (Refer to Output derating)
8	Electric strength voltages Input - Output 3000VAC 1 minute , Input - FG 1500VAC 1 minute , Output - FG 500VAC 1 minute
9	Insulation resistance 100M MIN DC500V 25 70%RH Input - Output, Input - FG, Output - FG
10	Leakage current 0.5mA MAX (240VAC, 50Hz)
11	Vibration 10 ~ 55Hz 2G (3 directions each 1 hour)
12	Shock 20 ms 20G (3 directions each 3 times)
13	Safety standards UL1950, CSA950(cUL), EN60950(TUV) Approvals
14	Conduction noise Meeting FCC Class B, EN55022 Class B, VCCI Class B
15	Harmonic distortion Meeting EN61000-3-2
16	Mains surge Meeting EN61000-3-5 Level 3 / 4KV(CM), 2KV(DM)

RSW100 SPECIFICATIONS

RSW100 SPECIFICATIONS

ITEM		RSW100-5	RSW100-12	RSW100-24
1	Rated output DC voltage	5V	12V	24V
2	Rated output DC current	*5 20A	8.4A	4.2A
3	Maximum output power	*5 100W	100.8W	100.8W
4	Efficiency(120/230VAC,TYP)	*1 78% / 80%	84% / 85%	84% / 85%
5	Input current	*1 1.6A (100VAC), 0.8A (240VAC)		
6	Power factor	*1 0.99 TYP (100VAC), 0.95 TYP (230VAC)		
7	Inrush current	*2 19Apk MAX (120VAC), 36Apk MAX (240VAC)		
8	Adjustable voltage range	*1 4.9 ~ 5.5V	11.7 ~ 13.2V	23.5 ~ 26.4V
9	Maximum ripple noise	50mVpp	120mVpp	240mVpp
10	Maximum line regulation	± 0.01%		
11	Maximum load regulation	± 0.1%		
12	Voltage tolerance ratio	± 3%, at line, load, time, temperature		
13	Hold-up time	*1 20ms MiN, after last AC line peak		
14	Over current protection	*3 21A ~	8.8A ~	4.4A ~
15	Over voltage protection	*4 5.75V ~	13.8V ~	27.6V ~
16	Dimensions	96.2(W) 200(D) 50(H) mm / 3.79"(W) 7.87"(D) 1.97"(H)		
17	Weight	750g / 1.65lb. TYP		

RSW150 SPECIFICATIONS

RSW150 SPECIFICATIONS

ITEM		RSW150-5	RSW150-12	RSW150-24
1	Rated output DC voltage	5V	12V	24V
2	Rated output DC current	*5 30A	12.5A	6.3A
3	Maximum output power	*5 150W	150W	151.2W
4	Efficiency(120/230VAC,TYP)	*1 78% / 80%	85% / 86%	85% / 86%
5	Input current	*1 2.4A (100VAC), 1.2A (240VAC)		
6	Power factor	*1 0.99 TYP (100VAC), 0.95 TYP (230VAC)		
7	Inrush current	*2 19Apk MAX (120VAC), 36Apk MAX (240VAC)		
8	Adjustable voltage range	*1 4.9 ~ 5.5V	11.7 ~ 13.2V	23.5 ~ 26.4V
9	Maximum ripple noise	50mVpp	120mVpp	240mVpp
10	Maximum line regulation	± 0.01%		
11	Maximum load regulation	± 0.1%		
12	Voltage tolerance ratio	± 3% at line, load, time, temperature		
13	Hold-up time	*1 20ms MiN, after last AC line peak		
14	Over current protection	*3 31.5A ~	13.1A ~	6.6A ~
15	Over voltage protection	*4 5.75V ~	13.8V ~	27.6V ~
16	Dimensions	96.2(W) 200(D) 50(H) mm / 3.79"(W) 7.87"(D) 1.97"(H)		
17	Weight	750g / 1.65lb. TYP		

NOTES

- *1 When maximum output is worked
- *2 When cold start works with rated voltage at 25 °C ambient temperature
- *3 Recovers automatically within 3 seconds, after on input again
- *4 Recovers on input again
- *5 Open frame(without cover), refer to Output derating

RSW200 SPECIFICATIONS

RSW200 SPECIFICATIONS

ITEM	RSW200-12	RSW200-24	RSW200-48
1 Rated output DC voltage	12V	24V	48V
2 Rated output DC current *5	16.7A	8.4A	4.2A
3 Maximum output power *5	200.4W	201.6W	201.6W
4 Efficiency(120/230VAC,TYP) *1	87% / 88%	87% / 90%	88% / 91%
5 Input current *1	2.8A (100VAC), 1.3A (240VAC)		
6 Power factor *1	0.99 TYP (100VAC), 0.95 TYP (230VAC)		
7 Inrush current *2	12Apk MAX (120VAC), 24Apk MAX (240VAC)		
8 Adjustable voltage range *1	11.7 ~ 13.2V	23.5 ~ 26.4V	47 ~ 52.8V
9 Maximum ripple noise	120mVpp	240mVpp	480mVpp
10 Maximum line regulation	± 0.01%		
11 Maximum load regulation	± 0.1%		
12 Voltage tolerance ratio	± 3% at line, load, time, temperature		
13 Hold-up time *1	20ms MiN, after last AC line peak		
14 Over current protection *3	17.5A ~	8.8A ~	4.4A ~
15 Over voltage protection *4	13.8V ~	27.6V ~	55.2V ~
16 Dimensions	119.2(W) 200(D) 53(H) mm / 4.69"(W) 7.87"(D) 2.09"(H)		
17 Weight	950g / 2.09lb. TYP		

RSW300 SPECIFICATIONS

RSW300 SPECIFICATIONS

ITEM	RSW300-12	RSW300-24	RSW300-48
1 Rated output DC voltage	12V	24V	48V
2 Rated output DC current *5	25A	12.5A	6.3A
3 Maximum output power *5	300W	300W	302.4W
4 Efficiency(120/230VAC,TYP) *1	86% / 89%	89% / 92%	89% / 92%
5 Input current *1	4.2A (100VAC), 2.2A (240VAC)		
6 Power factor *1	0.99 TYP (100VAC), 0.95 TYP (230VAC)		
7 Inrush current *2	12Apk MAX (120VAC), 24Apk MAX (240VAC)		
8 Adjustable voltage range *1	11.7 ~ 13.2V	23.5 ~ 26.4V	47 ~ 52.8V
9 Maximum ripple noise	120mVpp	240mVpp	480mVpp
10 Maximum line regulation	± 0.01%		
11 Maximum load regulation	± 0.1%		
12 Voltage tolerance ratio	± 3% at line, load, time, temperature		
13 Hold-up time *1	20ms MiN, after last AC line peak		
14 Over current protection *3	26.2A ~	13.1A ~	6.6A ~
15 Over voltage protection *4	13.8V ~	27.6V ~	55.2V ~
16 Dimensions	119.2(W) 200(D) 53(H) mm / 4.69"(W) 7.87"(D) 2.09"(H)		
17 Weight	980g / 2.16lb. TYP		

NOTES

- *1 When maximum output is worked
- *2 When cold start works with rated voltage at 25 ambient temperature
- *3 Recovers automatically within 3 seconds, after on input again
- *4 Recovers on input again
- *5 Open frame(without cover), refer to Output derating

RSW SERIES OUTLINE DRAWING

RSW 100/150

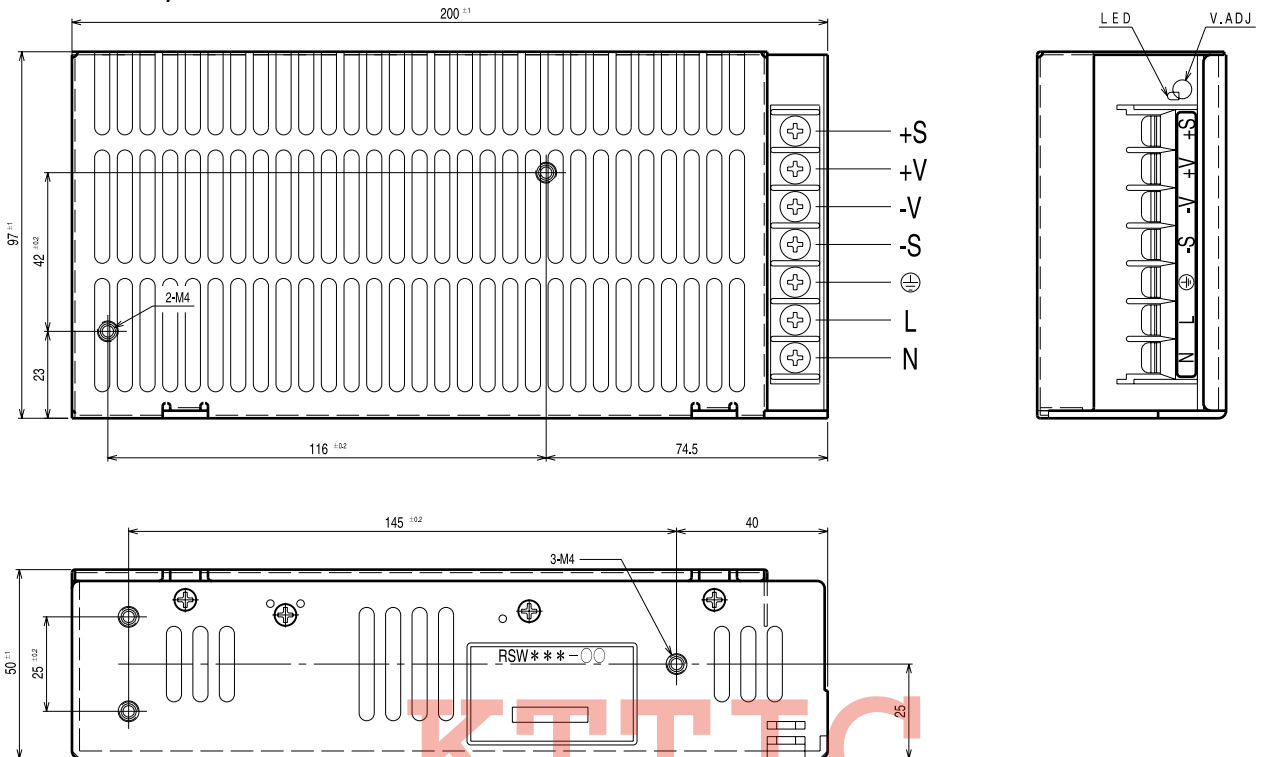

RSW 200/300

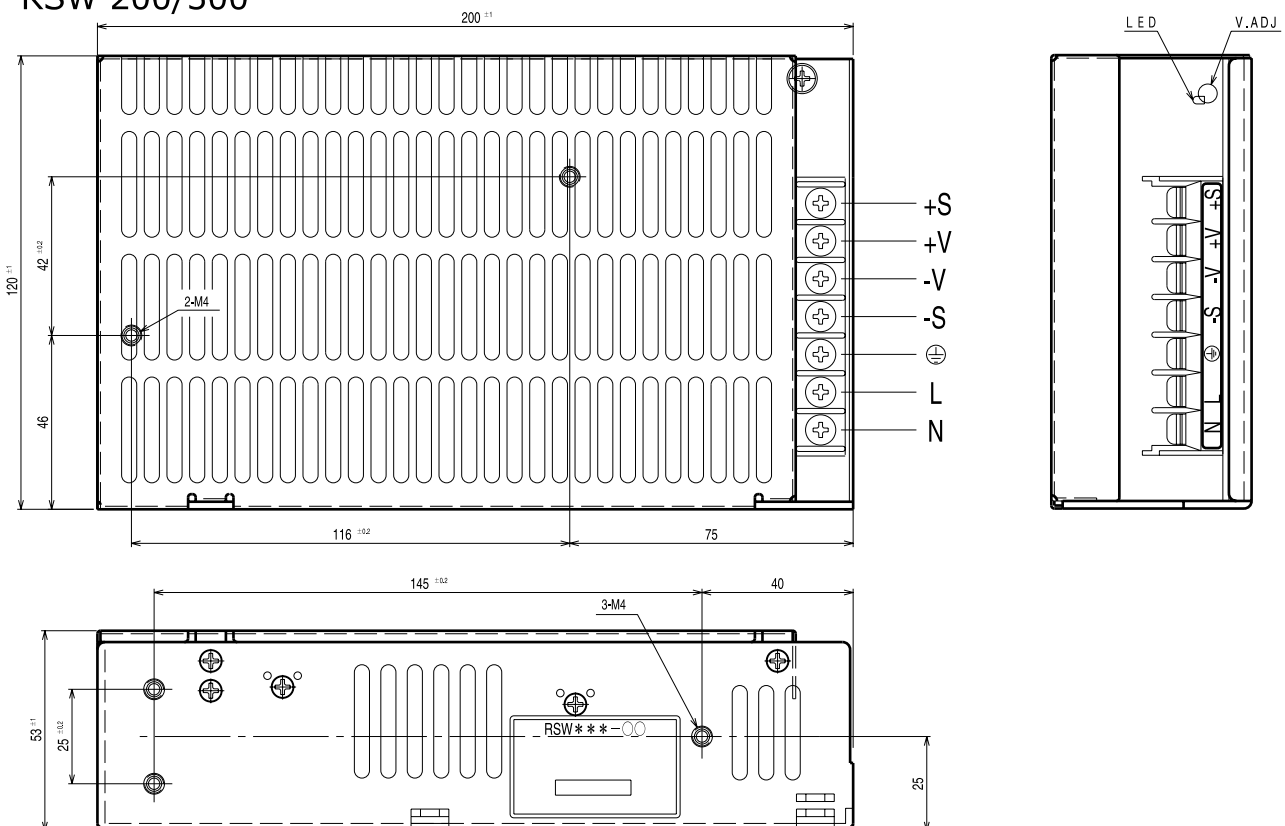

RSW SERIES

RSW SERIES OUTPUT DERATING

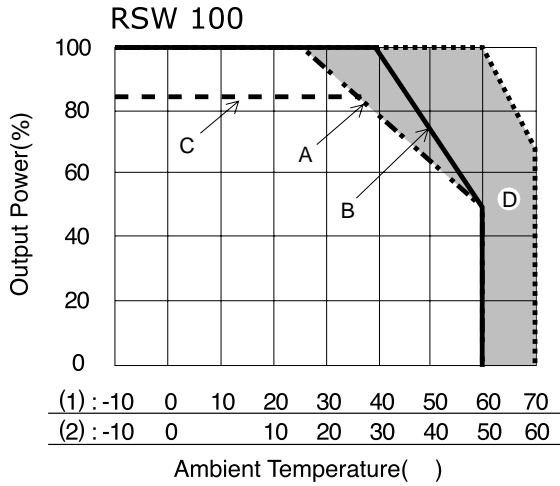

- A RSW100-5 open frame
- B RSW100-12,24
- C RSW100-5 with cover

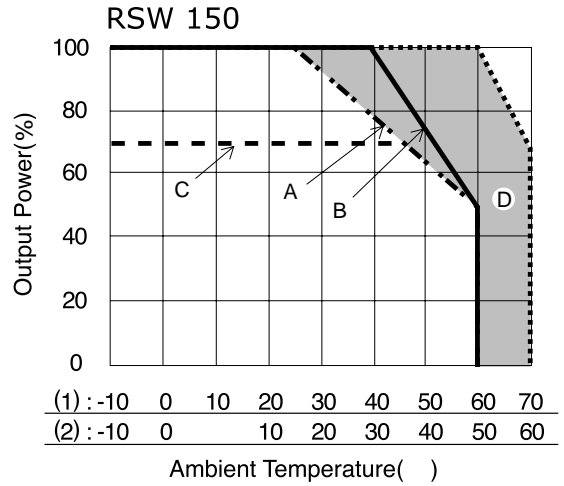

- A RSW150-5 open frame
- B RSW150-12,24
- C RSW150-5 with cover

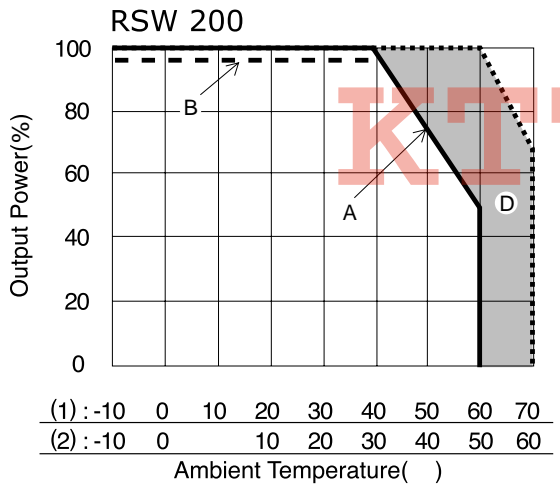

- A RSW200-12 open frame
RSW200-24,48
- B RSW200-12 with cover

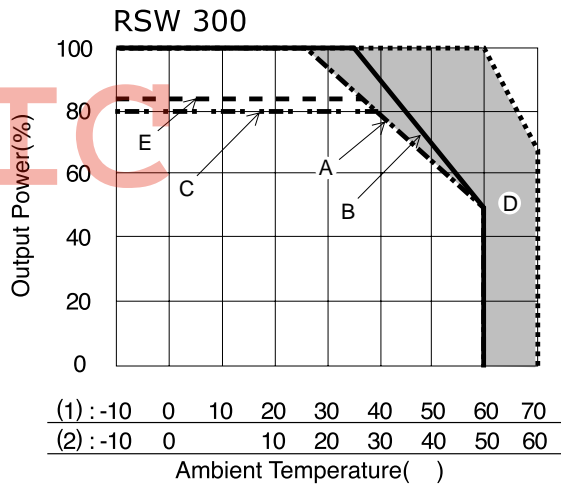

- A RSW300-12 open frame
- B RSW300-24,48 open frame
- C RSW300-12 with cover
- E RSW300-24,-48 with cover

Mounting Direction(conv)

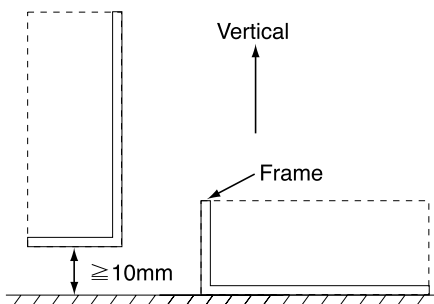

- (1) Open Frame (2) with Cover
 A B C E Conv D F / Air