

RF MEMS Switch

2SMES-01

**Surface-mount, 10 GHz Band (typical),
Miniature, SPDT-NO, RF MEMS Switch**

- Superior high-frequency characteristics at 10 GHz typical/8 GHz rated (50 Ω)
 - Isolation of 30 dB
 - Insertion loss of 1 dB
- Ultra-miniature 5.2 × 3.0 × 1.8 mm (L × W × H).
- Contact Reliability 100 million operations (0.5 mA at 0.5 VDC resistive load)
- Rated power consumption of 10 μW

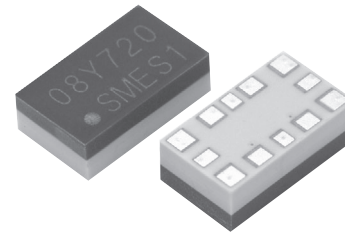

RoHS compliant

Terminal Arrangement

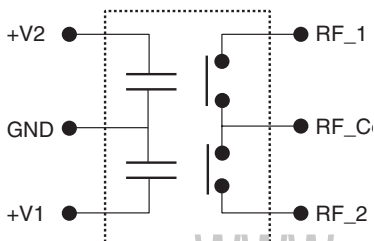

WWW.WOSENDONGLI.COM

Application Example

- Automatic test equipment
- RF measurement instrument
- RF component

List of Models

Standard Models with Surface-mounting Terminals

Classification	Structure	Packaging	Package quantity	Model
Single-side stable	Plastic sealed	JEDEC Tray	200	2SMES-01
		IC Pack	50	2SMES-01CT

■ Precautions

1. This RF MEMS Switch was developed on the assumption of cold switching. Do not exceed ratings by hot switching (greater than 0.5 mA at 0.5 VDC resistive load).
2. This RF MEMS Switch is easily damaged by static electricity. When handling the RF MEMS Switch, take countermeasures against static electricity. Contact OMRON for handling guidelines.

Specifications

■ Contact Ratings

Load	Resistive load
Rated load	0.5 mA at 0.5 VDC
Rated carry current	100 mA at 10 VDC RF: 30 dBm
Maximum switching voltage	0.5 VDC
Maximum switching current	0.5 mADC
Maximum switching capacity	0.25 mW

Note: This value is for a V.SWR of 1.2 max. at the load.

■ High Frequency Characteristics

Item	2 GHz	8 GHz	10 GHz	12 GHz
Isolation	---	30 dB		---
Insertion Loss	---	1 dB	1 dB (Typ.)	3 dB
Return Loss	---	10 dB		---
Maximum peak power	36 dBm	---		---
Maximum carry power	30 dBm	---		---

Note: 1. The impedance of the measurement system is 50 Ω.
2. The above values are initial values.
3. These values are for a V.SWR of 1.2 max. at the load.

■ Actuator Ratings

Rated voltage (VDC)	Rated current (mA)	Must operate voltage (V)	Must release voltage (V)	Absolute maximum voltage (V)	Rated power consumption (μW)	
DC	34±5%	---	90% max. of rated voltage	10% min. of rated voltage	40	10

Characteristics

Item	Single-side stable model	
	2SMES-01	
Contact resistance	1500 mΩ max.	
Operating time	100 μs max.	
Release time	100 μs max.	
Insulation resistance	V-GND	100 MΩ (at 40 VDC)
	others	100 MΩ (at 100 VDC)
Vibration resistance	Destruction	10 Hz to 500 Hz 10 G
	Malfunction	10 Hz to 500 Hz 10 G
Shock resistance	Destruction	100 G
	Malfunction	100 G
Life expectancy	Mechanical	100,000,000 Operations min.
	Electrical	100,000,000 Operations min.
ESD	100 V (Human body model)	
Ambient temperature	Operating: -20°C to 85°C (with no icing or condensation)	
Ambient humidity	Operating: 5% to 85%	
Weight	Approx. 0.1 g	

Note: 1. The above values are initial values.
2. The contact resistance was measured with 10 mA at 1 VDC with a voltage drop method.

Example of Drive Circuit for RF MEMS Switch

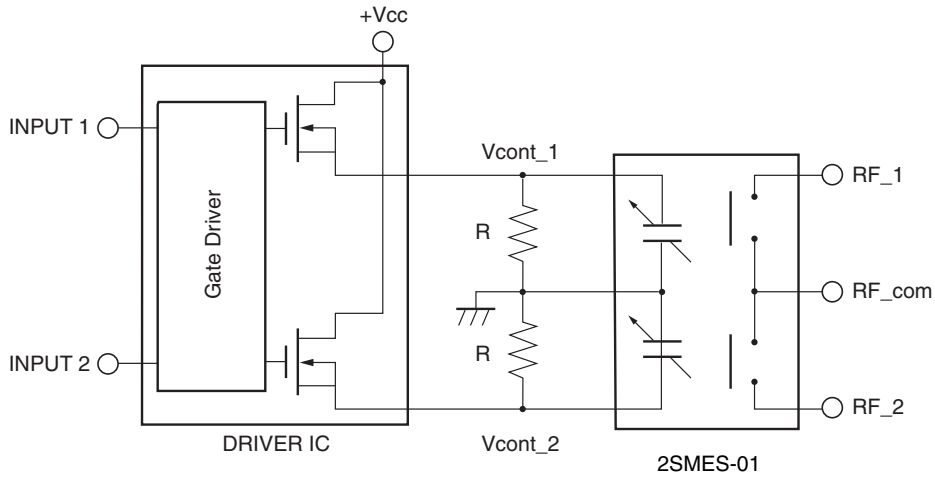

1. Operate the driving voltage with the high-side switch (V_{cont_1} & V_{cont_2} , not ground).
2. It is necessary to discharge the charge that accumulates in the electrostatic actuator to turn off the RF MEMS Switch because this product is a MEMS Switch of an electrostatic drive type. Install the electrical discharge circuit in the drive circuit of the RF MEMS Switch with a resistance of $1\text{ M}\Omega$ or less. Without an electrical discharge circuit, the RF MEMS Switch might not turn off, and the contacts could stick.

WWW.WOSENDONGLI.COM

Engineering Data (for reference)

■ High Frequency Characteristics

Insertion Loss

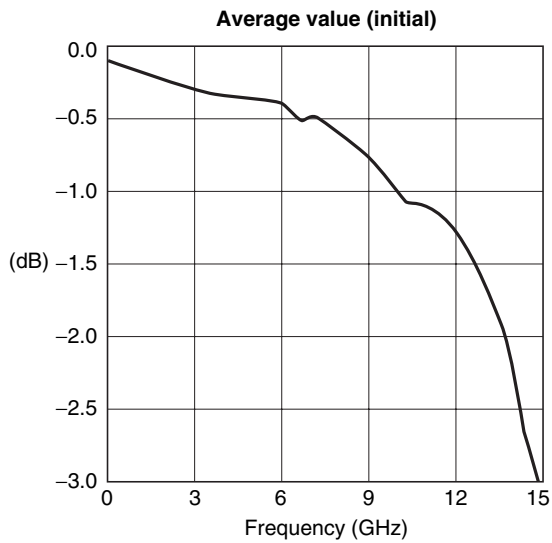

Isolation

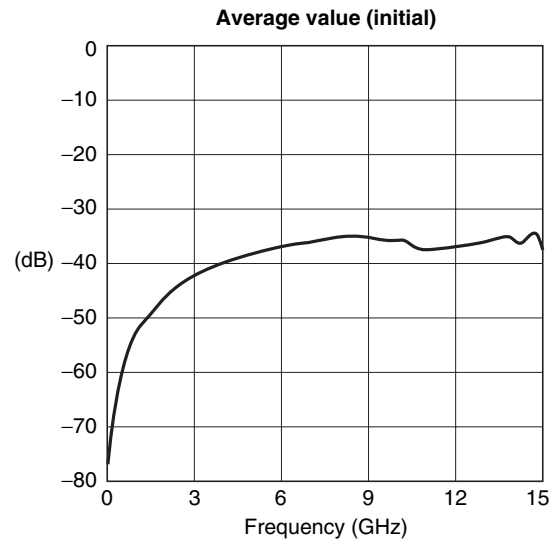

Return Loss

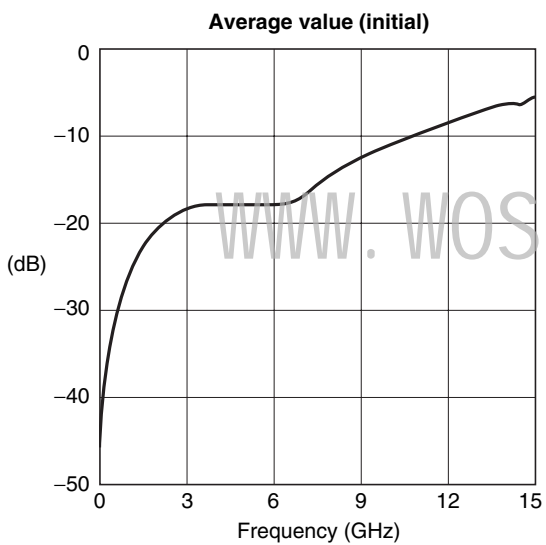

Note: 1. Ambient temperature condition: 23°C

2. These high-frequency characteristics are measured with RF probe. (without a mounting board)

3. The high-frequency characteristics depend on the mounting board. Be sure to check operation including durability in actual equipment before use.

Electrical Endurance (Contact Resistance Shift)

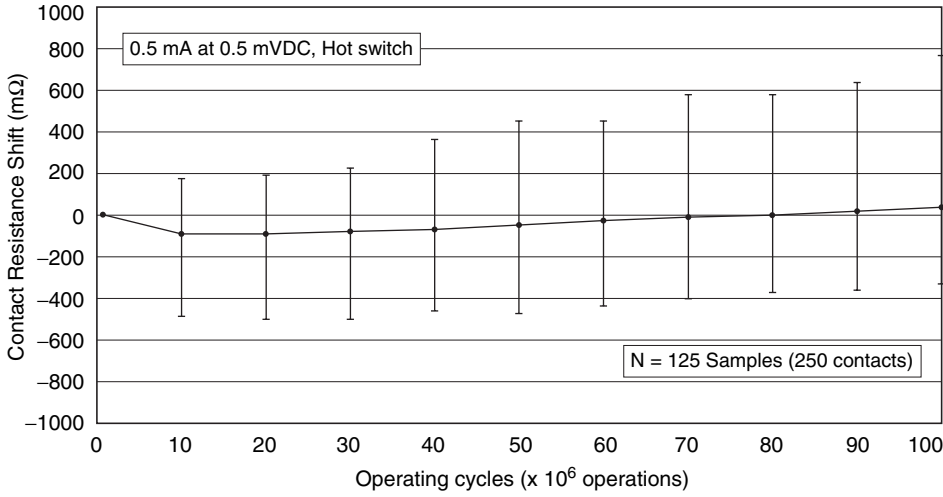

Electrical Endurance (Pickup Voltage/Release Voltage)

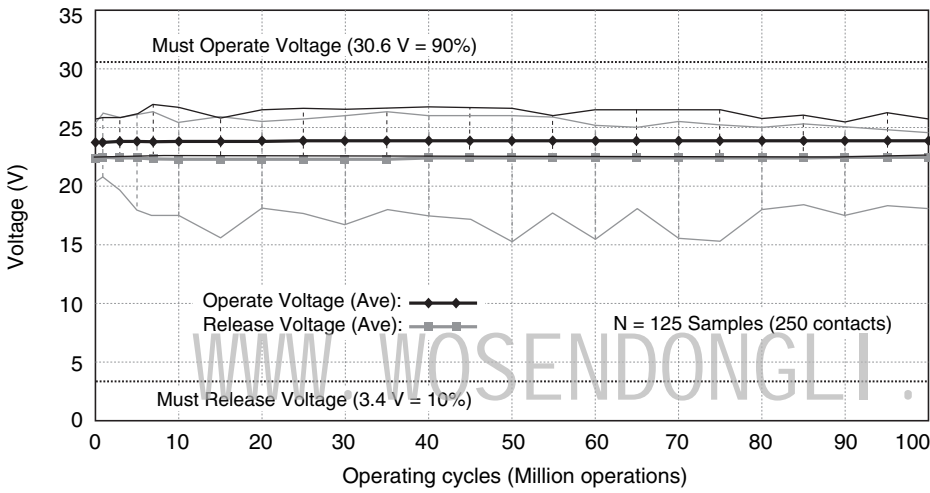

Ambient Temperature vs. Pickup voltage/Release Voltage

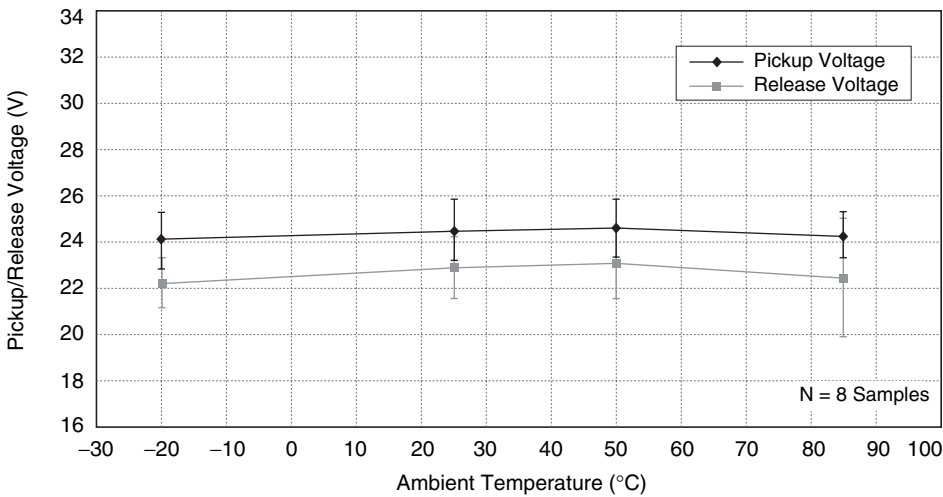

Dimensions

Note: All units are in millimeters unless otherwise indicated.

2SMES-01

Mounting PAD Dimensions (Top View)

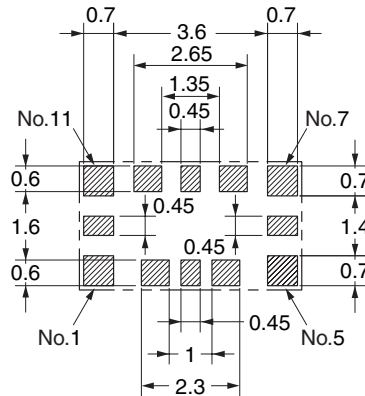
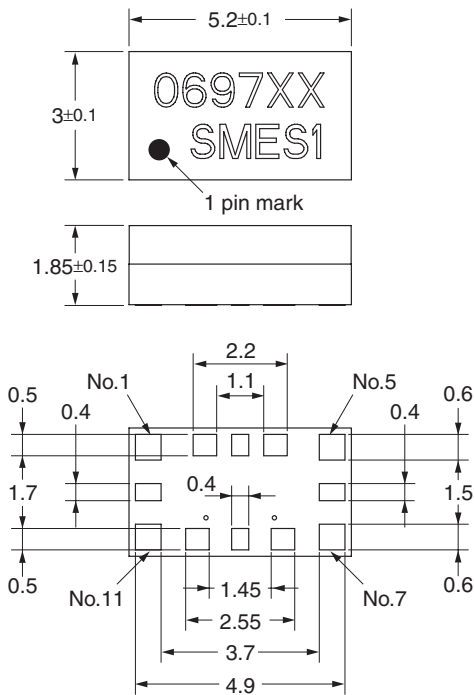

No.	Pin Arrangement
1	GND
2	GND
3	RF_com
4	GND
5	GND
6	RF_2
7	GND
8	Vcont_2
9	GND
10	Vcont_1
11	GND
12	RF_1

WWW.WOSENDONGLI.COM

Recommended Soldering Method

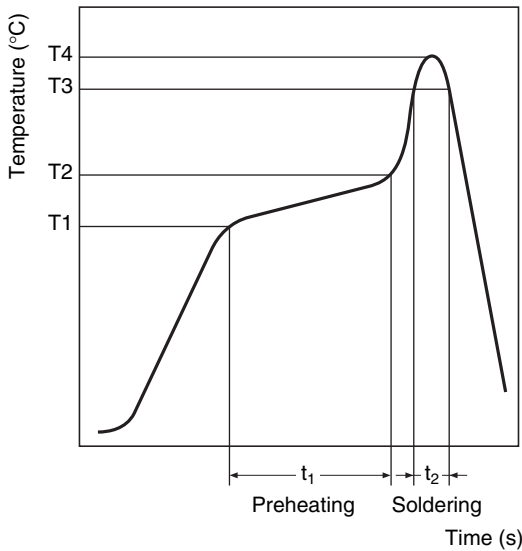

- The thickness of the solder paste is to be applied between 150 and 200 μm and the land pattern should be based on OMRON's recommended PCB pattern.
- To maintain the correct soldering joint shown in the following diagram, we recommend applying solder with the soldering conditions shown on the left.
- Check the soldering in the actual mounting conditions before use.
- When washing the product after soldering the RF MEMS Switch to a print circuit board, use a water-based solvent or alcohol-based solvent and keep the solvent temperature to less than 40°C.
- Do not put the RF MEMS Switch in a cold cleaning bath immediately after soldering.

Measuring position/Item	Preheating (T1 to T2, t ₁)	Soldering (T3, t ₂)	Peak value (T4)
Terminal	150°C to 180°C 120 s max.	230°C min. 30 s max.	250°C max.
Upper surface of case	---	---	255°C max.

Safety Precautions

■ Precautions for Correct Use

RF MEMS Switch Handling

- Use the RF MEMS Switch as soon as possible after opening the moisture-proof package (within one week). If the RF MEMS Switch is left for a long time after opening the moisture-proof package, the appearance may suffer and seal failure may occur after the solder mounting process. To store the RF MEMS Switch after opening the moisture-proof package, place it into the original package and seal the package with adhesive tape.
- When washing the product after soldering the RF MEMS Switch to a print circuit board, use a water-based solvent or alcohol-based solvent and keep the solvent temperature to less than 40°C. Do not put the RF MEMS Switch in a cold cleaning bath immediately after soldering.
- Do not use an Ultrasonic wash.
- This RF MEMS Switch is easily damaged by static electricity. When handling the RF MEMS Switch, take countermeasure against static electricity (100 V or less). Contact OMRON for additional guidelines.
- When handling the RF MEMS Switch, do not drop.
- Do not apply force resulting in the product to transform and change in quality.

Environmental Conditions for Usage, Storage, and Transport

- Avoid direct sunlight when using, storing, or transporting the RF MEMS Switch and maintain normal temperature, humidity, and pressure conditions.
- Avoid caustic gases when using, storing, or transporting the RF MEMS Switch.

Long-term, Continuous ON Contacts

- Using the RF MEMS Switch in a circuit where the RF MEMS Switch will be ON continuously for long periods (more than 24 hours) (rather than switching) can lead to unstable contacts. If a single-side stable model must be used in this kind of circuit, we recommend adding fail-safe circuits in case the contact fails.

Claw Securing Force During Automatic Mounting

- During automatic insertion of RF MEMS Switches, be sure to set the securing force of each claw to the following so that the RF MEMS Switch's characteristics will be maintained.

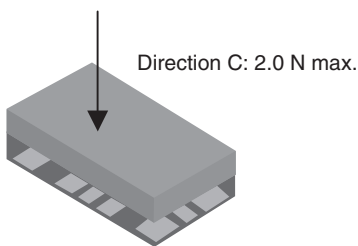

■ Precautions for Usage

- Turn off power when doing the exchange and the wiring work of the RF MEMS Switch.
- Do not touch the terminal of the RF MEMS Switch when energized.

Coating

- Do not coat the RF MEMS Switch when it is mounted to the print circuit board. Do not wash the print circuit board after the RF MEMS Switch is mounted using detergent containing silicone. Otherwise, the detergent may remain on the surface of the RF MEMS Switch.

For Reference Only

High frequency characteristics - method and substrate for measurement

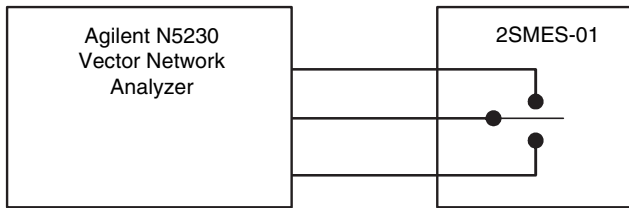

Substrate: $t = 1.6$ mm Rogers 4350B (Dielectric constant at 10 GHz: 3.48)

Evaluation Board Model: 2SMES-01-EVBA

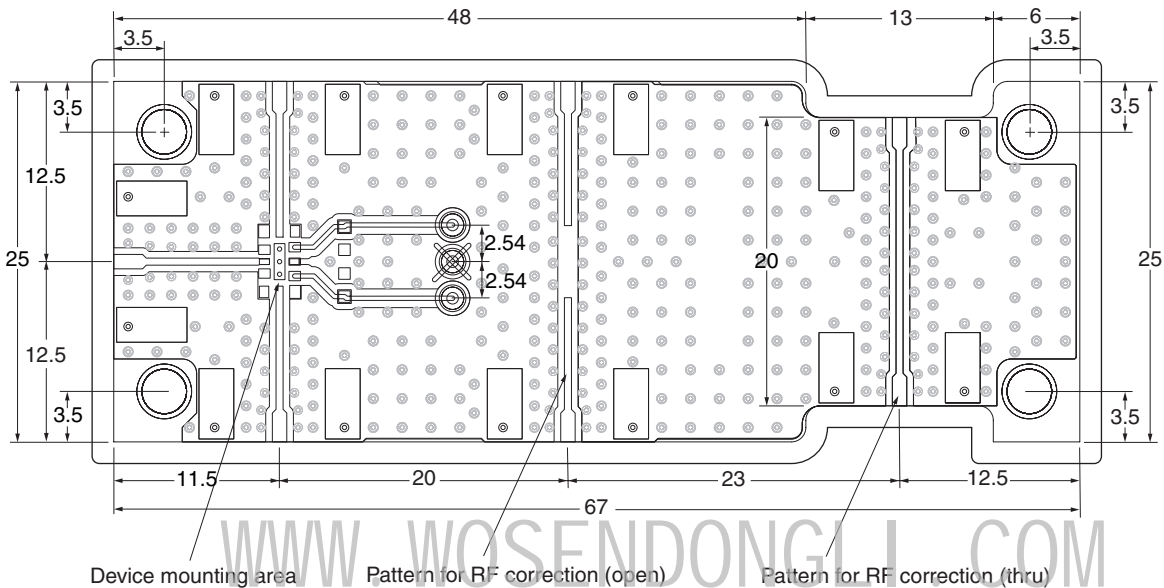

ALL DIMENSIONS SHOWN ARE IN MILLIMETERS.

To convert millimeters into inches, multiply by 0.03937. To convert grams into ounces, multiply by 0.03527.

Cat. No. A178-E1-01 **In the interest of product improvement, specifications are subject to change without notice.**

OMRON Corporation

Electronic Components Company

Semiconductor Division H.Q.

Micro Devices Division

686-1 Ichimiyake, Yasu,

Shiga, 520-2326 JAPAN

Tel: (81)77-587-7486/Fax: (81)77-587-7503

Printed in Japan
1208