



额定值・特性曲线

图 1. 正向电流・集电极损耗的温度额定值图



图 2. 正向电流—正向电压特性 (TYP.)



图 3. 光电流—正向电流特性 (TYP.)

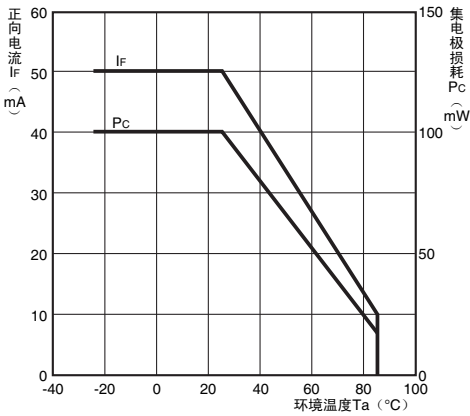

图 4. 光电流—集电极发射极之间的电压特性 (TYP.)

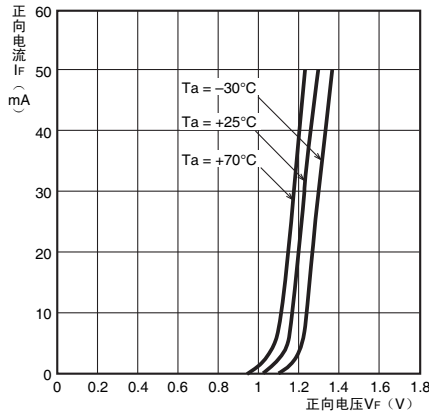

图 5. 相对光电流—环境温度特性 (TYP.)

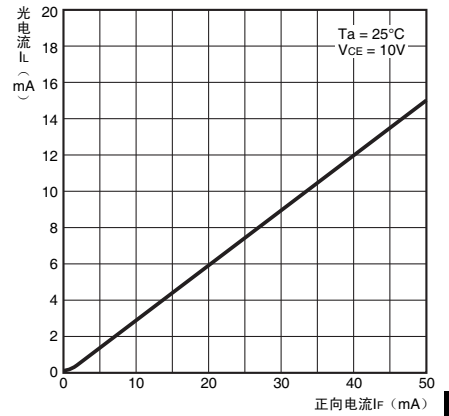

图 6. 暗电流—环境温度特性 (TYP.)

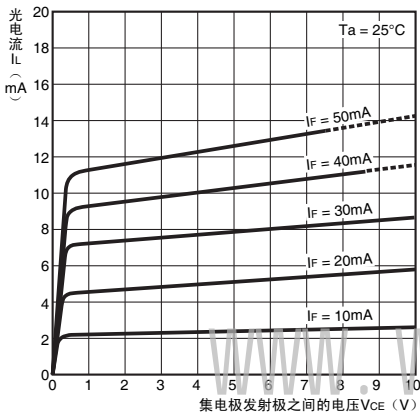

图 7. 应答时间—负载电阻特性 (TYP.)

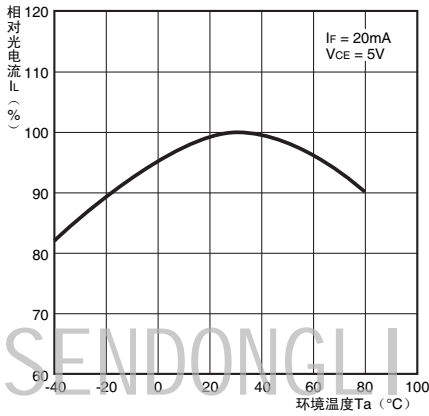

图 8. 检测位置特性 (TYP.)

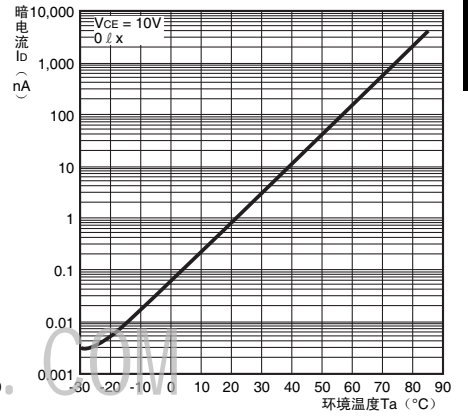

图 9. 检测位置特性 (TYP.)

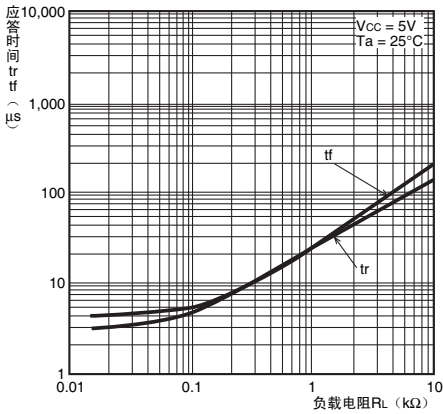

图 10. 应答时间测定回路

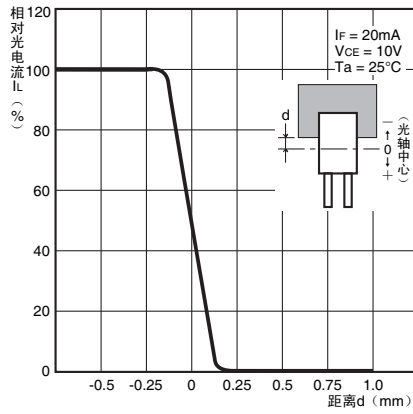
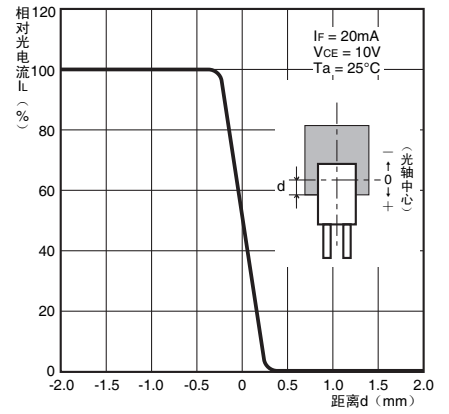
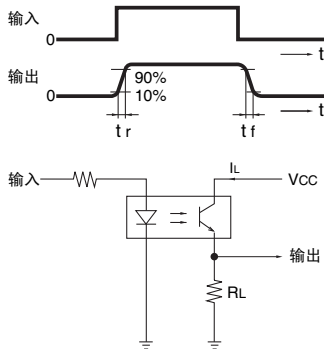

微型光电传感器 EE-SX1128