

MITSUBISHI PHOTO DIODES

PD7XX7 SERIES

InGaAs PIN PHOTO DIODES

PD7087, PD708C7, PD7937, PD793D7

DESCRIPTION

PD7XX7 Series are InGaAs pin photodiodes which has a sensitive area of ϕ 40mm. PD7XX7 is suitable for receiving the light having a wavelength band of 1000 to 1600nm. This photodiode features high-speed response and a high quantum efficiency, and is suitable for the light receiving elements for optical fiber communication systems.

Feature

- ϕ 40mm active diameter
- 1000~1600nm wavelength band
- Small dark current
- High speed response
- High quantum efficiency
- Ball lens cap(PD708C7)

APPLICATION

Receiver for optical communication system



ABSOLUTE MAXIMUM RATINGS

Symbol	Parameter	Conditions	Ratings	Unit
Vr	Reverse voltage	-	20	V
Ir	Reverse current	-	500	mA
If	Forward current	-	2	mA
Tc	Case temperature	-	-40 ~ +85	° C
Tstg	Storage temperature	-	-40 ~ +100	° C

ELECTRICAL / OPTICAL CHARACTERISTICS (Tc=25°C)

Symbol	Parameter	Test conditions	Limits			Unit
			Min.	Typ.	Max.	
Ct	Capacitance	Vr=5V, f=1MHz	-	0.8 *1	-	pF
Id	Dark current	Vr=5V	-	0.05	1	nA
R	Responsivity	Vr=5V, λ =1300nm	0.7	0.90 *2	-	A/W
fc	Cut-off frequency	Vr=5V, λ =1300nm, RL=50W, -3dB	-	2.5	-	GHz

*1 Applied to PD7937: Ct=0.6pF(typ.), PD793D7: Ct=0.5pF(typ.)

*1 0.85A/W typical fiber coupling sensitivity with GI 50/125 for PD708C7

PD7XX7 SERIES

OUTLINE DRAWINGS

PD7087



-  CD header
-  Flat glass cap
-  3 pin

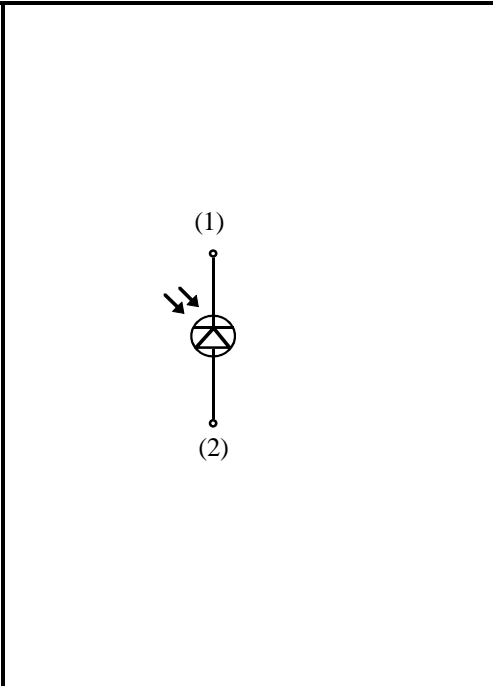
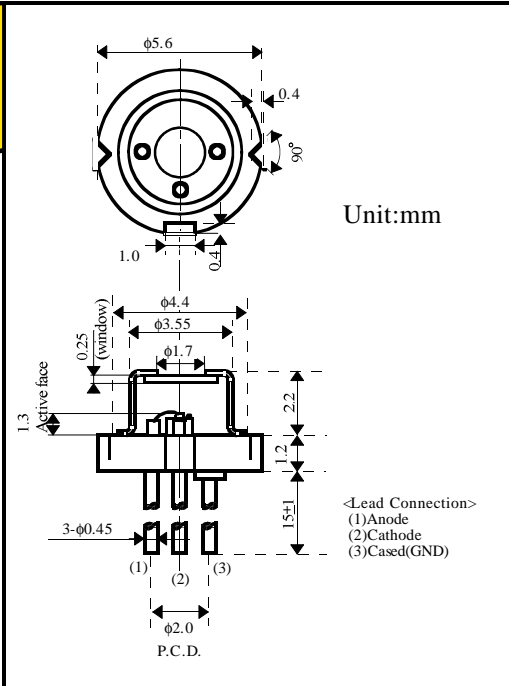

PD708C7



-  CD header
-  Ball lens
-  3 pin

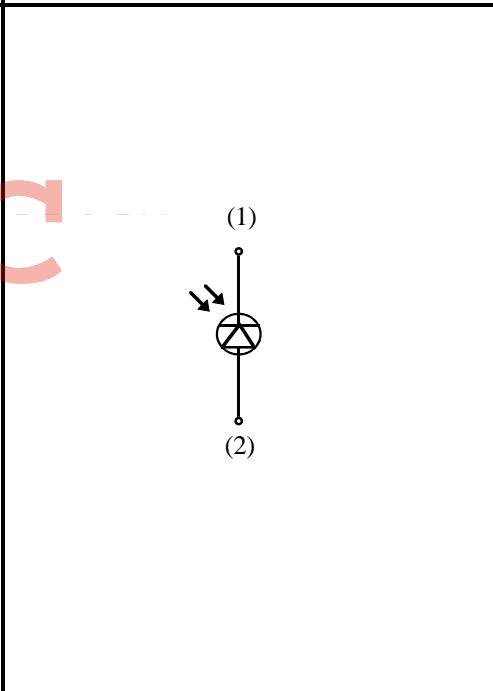
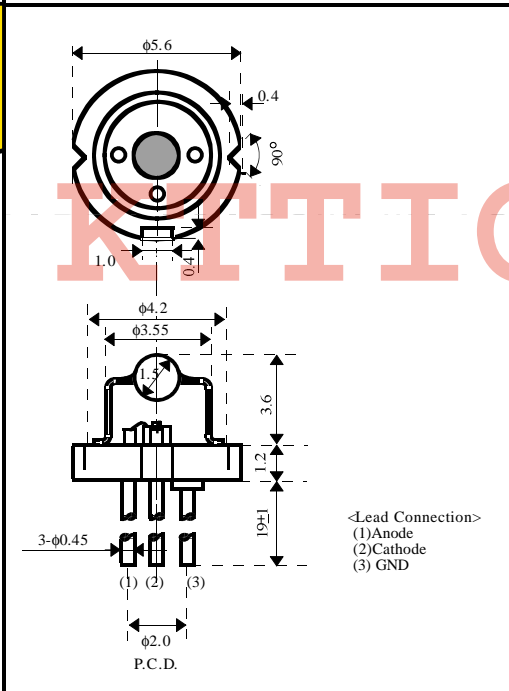

PD7937



-  Alumina submount

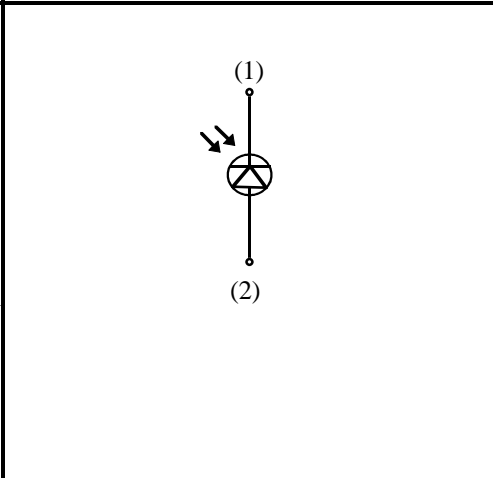
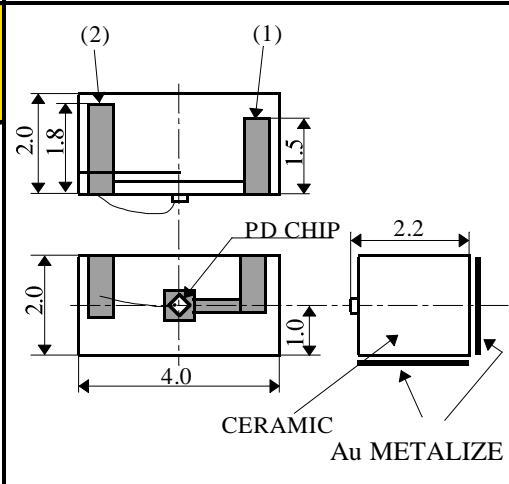

OUTLINE DRAWINGS

PD793D7



 Alumina submount

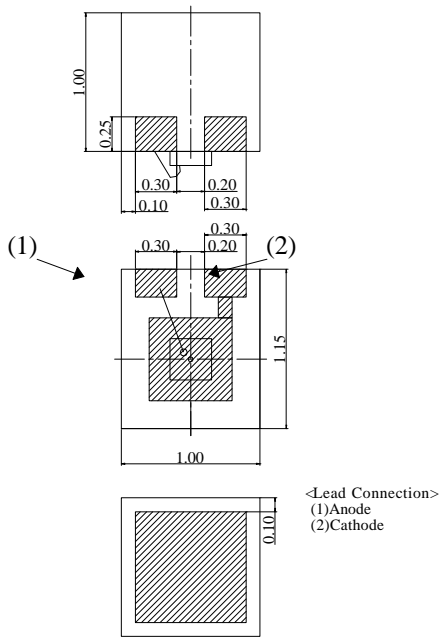

KTTIC