

# M63832GP/KP

7-UNIT 500mA DARLINGTON TRANSISTOR-ARRAY

**PRELIMINARY**

Notice: This is not a final specification.  
Some parametric limits are subject to change.

### DESCRIPTION

The M63832GP/KP 7-channel sinkdriver, consists of 7 PNP and 14 NPN transistors connected to form seven high current gain driver pairs.

### FEATURES

- High breakdown voltage ( $BV_{CEO} \geq 50V$ )
- High-current driving ( $I_{C(max)} = 500mA$ )
- 3V micro computer compatible input
- "L" active level input
- With input diode
- Wide operating temperature range ( $T_a = -40$  to  $+85^\circ C$ )

### APPLICATION

Output for 3 voltage microcomputer series and interface with high voltage system. Relay and small printer driver, LED, or incandescent display digit driver.

### FUNCTION

The M63832GP/KP is transistor-array of high active level seven units type which can do direct drive of 3 voltage micro-computer series. A resistor of  $3.5k\Omega$  is connected between the input and the base of PNP transistors. The input diode is intended to prevent the flow of current from the input to the Vcc. Without this diode, the current flows from "H" input to the Vcc and the "L" input circuit is activated, in such a case where one of the inputs of the 7 circuit is "H" and the other are "L" to save power consumption. The diode is inserted to prevent such mis-operation. The outputs are capable of driving 500mA and are rated for operation with output voltage up to 50V.

### PIN CONFIGURATION

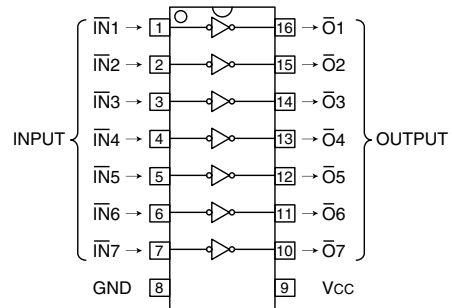

16P2S-A(GP)  
Package type 16P2Z-A(KP)

### CIRCUIT DIAGRAM

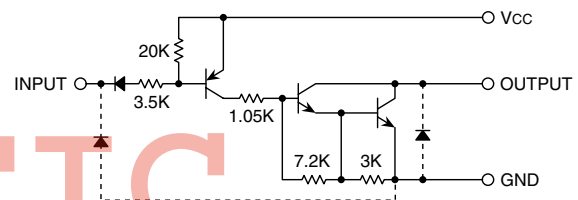

The seven circuits share the Vcc and GND

The diode, indicated with the dotted line, is parasitic, and cannot be used.

Unit :  $\Omega$

### ABSOLUTE MAXIMUM RATINGS (Unless otherwise noted, $T_a = -40 \sim +85^\circ C$ )

Symbol	Parameter	Conditions	Ratings	Unit
Vcc	Supply voltage		7	V
VCEO	Collector-emitter voltage	Output, H	-0.5 ~ +50	V
IC	Collector current	Current per circuit output, L	500	mA
Vi	Input voltage		-0.5 ~ Vcc	V
Pd	Power dissipation	$T_a = 25^\circ C$ , when mounted on board	0.80(FP)/0.78(KP)	W
Topr	Operating temperature		-40 ~ +85	$^\circ C$
Tstg	Storage temperature		-55 ~ +125	$^\circ C$

**PRELIMINARY**  
 Notice: This is not a final specification.  
 Some parametric limits are subject to change.

**M63832GP/KP**

7-UNIT 500mA DARLINGTON TRANSISTOR-ARRAY

**RECOMMENDED OPERATING CONDITIONS** (Unless otherwise noted, Ta = -40 ~ +85°C)

Symbol	Parameter	Limits			Unit	
		min	typ	max		
Vcc	Supply voltage	2.7	3.0	3.6	V	
Ic	Collector current (Current per 1 circuit when 7 circuits are coming on simultaneously)	Duty Cycle GP/KP : no more than 2%	0	—	400	mA
		Duty Cycle GP/KP : no more than 10%	0	—	200	
VIH	"H" input voltage	Vcc-0.5	—	Vcc	V	
VIL	"L" input voltage	0	—	Vcc-2.2	V	

**ELECTRICAL CHARACTERISTICS** (Unless otherwise noted, Ta = -40 ~ +85°C)

Symbol	Parameter	Test conditions	Limits			Unit
			min	typ*	max	
V (BR) CEO	Collector-emitter breakdown voltage	ICEO = 100µA	50	—	—	V
VCE(sat)	Collector-emitter saturation voltage	VCC = 2.7V, VI = 0.5V, IC = 400mA	—	1.15	2.4	V
		VCC = 2.7V, VI = 0.5V, IC = 200mA	—	0.93	1.6	
Ii	Input current	VI = VCC-2.2V	—	-220	-600	µA
ICC	Supply current (AN only Input)	VCC = 3.6V, VI = 0.5V	—	2.6	4.0	mA
hFE	DC amplification factor	VCC = 2.7V, VCE = 2V, IC = 0.35A, Ta = 25°C	2000	10000	—	—

\* : Typical values are at Ta = 25°C

**SWITCHING CHARACTERISTICS** (Unless otherwise noted, Ta = 25°C)

Symbol	Parameter	Test conditions	Limits			Unit
			min	typ	max	
ton	Turn-on time	CL = 15pF (note 1)	—	120	—	ns
toff	Turn-off time		—	4500	—	

**NOTE 1 TEST CIRCUIT**

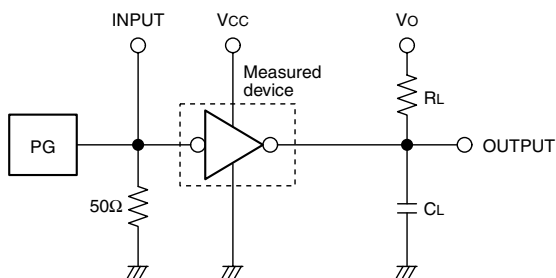

- (1) Pulse generator (PG) characteristics : PRR=1kHz, tw = 10µs, tr = 6ns, tf = 6ns, Zo = 50Ω, VI = 0.5 ~ 2.7V
- (2) Input-output conditions : RL = 30Ω, Vo = 10V, Vcc = 2.7V
- (3) Electrostatic capacity CL includes floating capacitance at connections and input capacitance at probes

**TIMING DIAGRAM**

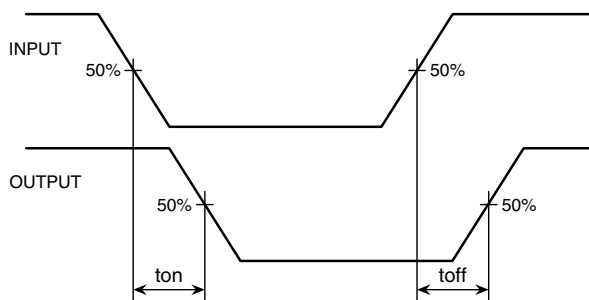

**PRELIMINARY**  
 Notice: This is not a final specification.  
 Some parametric limits are subject to change.

**M63832GP/KP**

7-UNIT 500mA DARLINGTON TRANSISTOR-ARRAY

**TYPICAL CHARACTERISTICS**

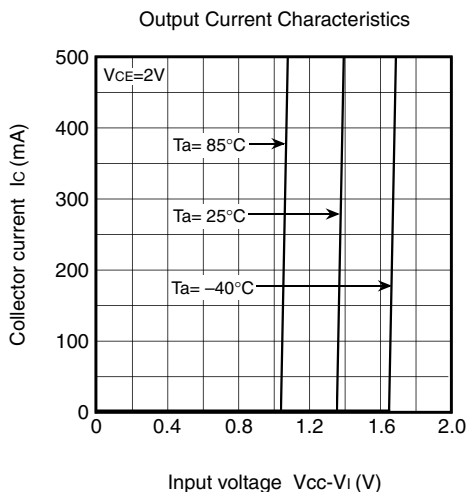
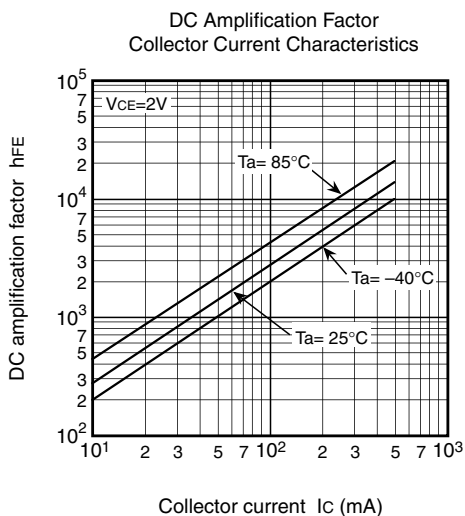
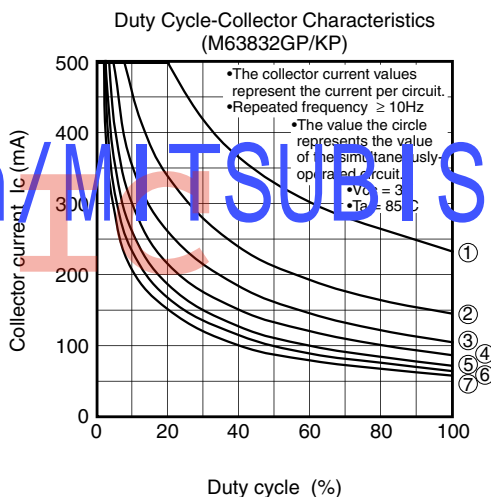
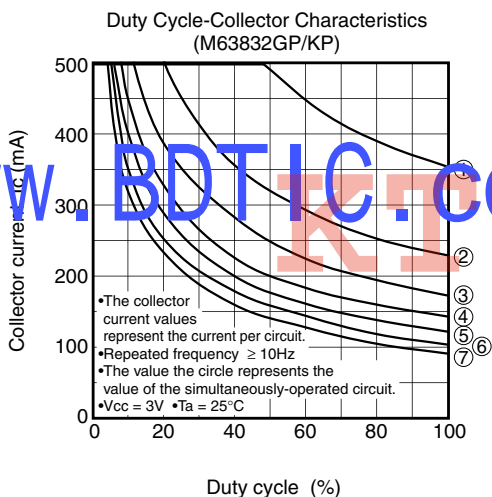
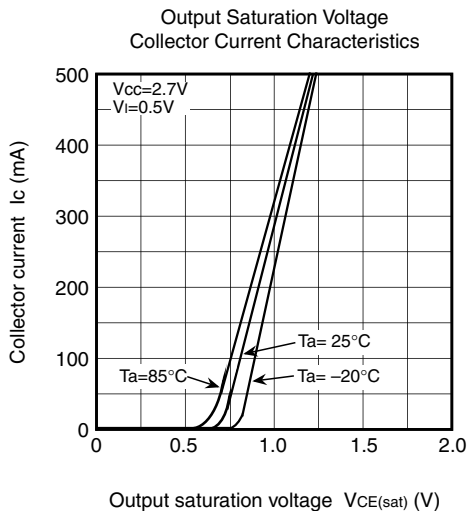
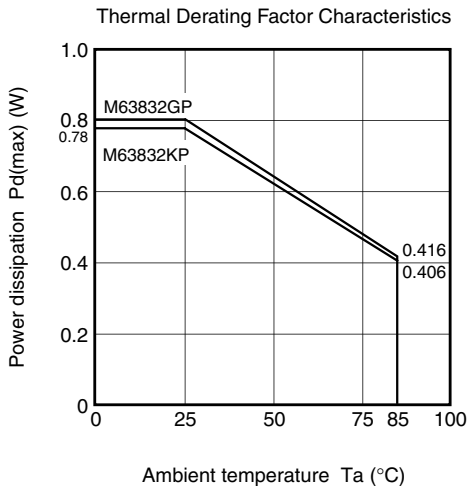

**PRELIMINARY**  
Notice: This is not a final specification.  
Some parametric limits are subject to change.

**M63832GP/KP**

7-UNIT 500mA DARLINGTON TRANSISTOR-ARRAY

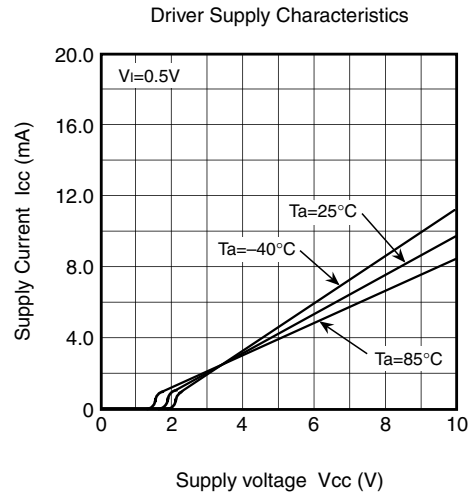
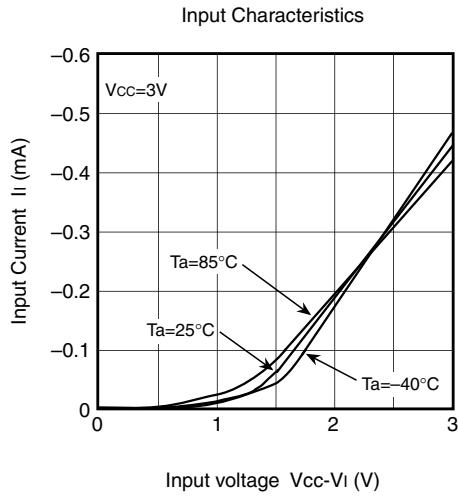

[www.BDTIC.com/MITSUBISHI](http://www.BDTIC.com/MITSUBISHI)