

INNOLUX DISPLAY CORPORATION
LCD MODULE
SPECIFICATION

Customer: _____
Model Name: PT035TN01 V.1
SPEC NO.: P035-01-TT-01
Date: 2005/08/15
Version: 1

Preliminary Specification
 Final Specification

For Customer's Acceptance

Approved by	Comment

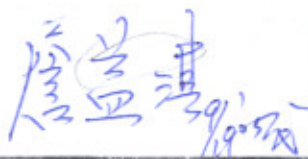
Approved by	Reviewed by	Prepared by
	蔡明宏 9/19/05	许盼盼 8/18/05

Record of Revision

Version	Revise Date	Page	Content
1	2005/08/15		Initial Release
2	2005/09/06	4 14	Modify the Operation Temperature from -10~60°C to -20~70°C Modify the Storage Temperature from -20~70°C to -30~80°C



Contents

1. General Specifications	1
2. Pin Assignment	2
3. Operation Specifications	4
3.1. Absolute Maximum Rating	4
3.2. Electrical Characteristics	5
3.2.1. Typical Operation Conditions	5
3.2.2. Current Consumption	6
3.2.3. Backlight Driving Condition	6
3.3. Timing Characteristics	7
3.3.1. AC Electrical Characteristics	7
4. Optical Specifications	11
5. Reliability Test Items	15
6. Handling Precautions	16
6.1. Safety	16
6.2. Handling	16
6.3. Static Electricity	16
6.4. Storage	16
6.5. Cleaning	16
7. Mechanical Drawing	17
8. Package Drawing	18
8.1. Packaging Material Table	18
8.2. Packaging Quantity	18
8.3. Packaging Drawing	19

1. General Specifications

No.	Item	Specification	Remark
1	LCD size	3.5" inch	
2	Driver element	a-Si TFT active matrix	
3	Resolution	320X3(RGB)X240	
4	Display mode	Normally White, Transmissive	
5	Dot pitch	0.073(W)X0.219(H) mm	
6	Active area	70.08(W)X52.56(H) mm	
7	Module size	78.2(W)X65.0(H)X3.5(D) mm	Note 1
8	Surface treatment	Anti Glare	
9	Color arrangement	RGB-stripe	
10	Interface	Digital	
11	Backlight Power consumption	0.43W (Typ.)	
12	Panel Power Consumption	TBD	
13	Weight	TBD	

Note 1: Refer to Mechanical Drawing.

2. Pin Assignment

Pin No.	Symbol	I/O	Function	Remark
1	NC	-	No connect	
2	G_V _{SS}	P	V _{SS} for gate driver	
3	G_V _{DD}	P	V _{DD} for gate driver	
4	V _{GL}	P	Negative power for scan driver	
5	V _{GH}	P	Positive power for scan driver	
6	V _{COM}	I	Common electrode driving signal	
7	GND	P	Ground for logic circuit	
8	RSTB	I	Reset Pin, Active low to enter Reset State.	
9	NC	-	No connect	
10	NC	-	No connect	
11	NC	-	No connect	
12	NC	-	No connect	
13	NC	-	No connect	
14	SPENB	I	Serial port Data Enable Signal. Active low	
15	SPCK	I	Serial port Clock .Rising edge latch	
16	SPDA	I/O	Serial port Data input/output	
17	VCOMOUT	O	Frame polarity output for panel Vcom	
18	NC	-	No connect	
19	GND	P	Ground for logic circuit	
20	GLED2	P	GND for LED	
21	VLED2	P	Power for LED	
22	GLED1	P	GND for LED	
23	VLED1	P	Power for LED	

版權屬於研創所有，禁止任何未經授權的使用

24	AV _{DD}	P	Analog power supply(+5V)	
25	NC	-	No connect	
26	NC	-	No connect	
27	V6	P	Gamma Correction reference voltage	
28	V5	P	Gamma Correction reference voltage	
29	V4	P	Gamma Correction reference voltage	
30	V3	P	Gamma Correction reference voltage	
31	V2	P	Gamma Correction reference voltage	
32	V1	P	Gamma Correction reference voltage	
33	AGND	P	Analog ground.	
34	D07	I	Data INPUT (MSB)	
35	D06	I	Data INPUT	
36	D05	I	Data INPUT	
37	D04	I	Data INPUT	
38	D03	I	Data INPUT	
39	D02	I	Data INPUT	
40	D01	I	Data INPUT	
41	D00	I	Data INPUT(LSB)	
42	CLK	I	Clock signal	
43	HSD	I	Horizontal sync input.	
44	VSD	I	Vertical sync input.	
45	DEN	I	Input data enable control, Active high to enable the data input Bus under "DE mode".	
46	NC	-	No connect	
47	V _{CC}	P	Supply voltage of logic control circuit for scan driver	
48	GND	P	Ground for logic circuit	
49	V _{COM}	I	Common electrode driving signal.	
50	V _{GL}	P	Negative power for scan driver	

3. Operation Specifications

3.1. Absolute Maximum Rating

(GND=AGND=0V, Note 1)

Item	Symbol	Values		Unit	Remark
		Min.	Max.		
Power voltage	V_{CC}	-0.3	5	V	
	AV_{DD}	-0.5	7.5	V	
	V_{GH}	-0.3	18	V	
	V_{GL}	-15	0.3	V	
	$V_{GH}-V_{GL}$	-	33	V	
Operation Temperature	T_{OP}	-20	70	°C	
Storage Temperature	T_{ST}	-30	80	°C	

Note 1: The absolute maximum rating values of the module should not be exceeded. Once exceeding absolute maximum rating values, the characteristics of the module may not be recovered. Even in an extreme condition, it may result in module permanently destroyed.

3.2. Electrical Characteristics

3.2.1. Typical Operation Conditions

(GND=AGND=0V, Note 2)

Item	Symbol	Values			Unit	Remark
		Min.	Typ.	Max.		
Power voltage	V_{CC}	3.0	3.3	3.6	V	
	AV_{DD}	-	5.0	-	V	
	V_{GH}	-	TBD	-	V	
	V_{GL}	-	TBD	-	V	
V_{COM}	V_{CAC}	-	TBD	-	V	Note 1
	V_{CDC}	-	TBD	-	V	DC component
Input logic high voltage	V_{IH}	$0.7V_{CC}$	-	V_{CC}	V	
Input logic low voltage	V_{IL}	0	-	$0.3V_{CC}$	V	

Note 1: The brightness of LCD panel could be changed by adjusting the AC component of V_{COM} .

Note 2: Be sure to apply GND, V_{CC} , and V_{GL} , to the LCD first, and then apply V_{GH} .

3.2.2. Current Consumption

(GND=AGND=0V)

Item	Symbol	Values			Unit	Remark
		Min.	Typ.	Max.		
Current for Driver	I_{GH}	-	TBD	-	mA	$V_{GH} = TBD$
	I_{GL}	-	TBD	-	mA	$V_{GL} = TBD$
	I_{CC}	-	TBD	-	mA	$V_{CC} = 3.3V$
	I_{DD}	-	TBD	-	mA	$AV_{DD} = 5V$

3.2.3. Backlight Driving Condition

Item	Symbol	Values			Unit	Remark
		Min.	Typ.	Max.		
LED voltage	V_L	-	(10.8)	-	V	Note 1
LED current	I_L	-	(20)	-	mA	Note 1
LED life time	-	10,000	-	-	Hr	Note 2

Note 1: The LED driving condition is defined for each LED module.(See the figure)

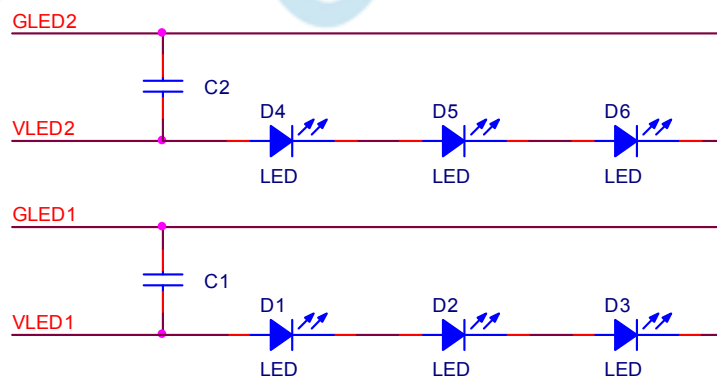

Note 2: The “LED life time” is defined as the module brightness decrease to 50% original brightness that the ambient temperature is 25°C and $I_L = 20mA$.

版權屬於群創所有，禁止任何未經授權的使用

3.3. Timing Characteristics

3.3.1. AC Electrical Characteristics

AC Electrical Characteristics(VCC=3.3V,AVDD=5.0V, GND=AGND=0V,TA=25°C)

Item	Symbol	Values			Unit.	Remark
		Min.	Typ.	Max.		
System Operation Timing						
VDD power on slew time	T _{POR}			1000	us	From 0V to 90% VDD
Input Output Timing						
CLKIN clock time	T _{clk}	-		37	ns	CLKIN=27Mhz
HSD to CLKIN	T _{hc}	-	-	1	CLKIN	
HSD width	T _{hwh}	1	-	-	CLKIN	
VSD width	T _{vwh}	1	-	-	Th	
HSD period time	Th	60	63.56	67	us	
VSD setup time	T _{vst}	12	-	-	ns	
VSD hold time	T _{vhd}	12	-	-	ns	
HSD setup time	T _{hst}	12	-	-	ns	
Data set-up time	T _{dsu}	12	-	-	ns	DIN[7:0] to CLKIN
Data hold time	T _{dhd}	12	-	-	ns	DIN[7:0] to CLKIN
DEN setup time	T _{esd}	12	-	-	ns	DEN to CLKIN
VCOMOUT output stable time	T _{cst}	-	4	8	us	96% final, CLcom=33nF, RLcom=100ohm
3-wire serial communication AC timing						
Serial Clock Period Time	T _{spck}	320	-	-	ns	
SPCK pulse duty cycle	T _{scdut}	40	50	60	%	
Serial data setup time	T _{isu}	120	-	-	ns	
Serial data hold time	T _{ihd}	120	-	-	ns	
Serial clock high/low	T _{ssw}	120	-	-	ns	

SPENA select distinguish	Tcd	1	-	-	us	
SPENA to VSD	Tcv	1	-	-	us	

Timing Table

CCIR601 Mode A/B*(Note 1)

ITEM	Symbol	Value			Unit	Remark
		Min.	Typ.	Max.		
CLKIN frequency	Fclk	-	24.54/27	30	Mhz	VCC=3.3V
CLKIN cycle time	Tclk	-	40/37	-	ns	
CLKIN pulse duty	Tcwh	40	50	60	%	Tclk

CCIR656 Mode A/B*(Note 1)

ITEM	Symbol	Value			Unit	Remark
		Min.	Typ.	Max.		
CLKIN frequency	Fclk	-	27	30	Mhz	VCC=3.3V
CLKIN cycle time	Tclk	-	37	-	ns	
CLKIN pulse duty	Tcwh	40	50	60	%	Tclk

8 bit RGB 960x240 Mode

ITEM	Symbol	Value			Unit	Remark
		Min.	Typ.	Max.		
CLKIN frequency	Fclk	-	27	30	Mhz	VCC=3.3V
CLKIN cycle time	Tclk	-	37	-	ns	
CLKIN pulse duty	Tcwh	40	50	60	%	Tclk

Note 1: YUV mode A: Data sequence are "Cb-Y-Cr-Y..."
 YUV mode B: Data sequence are "Cr-Y-Cb-Y..."

Timing Diagram

Clock and Data Input Timing Diagram

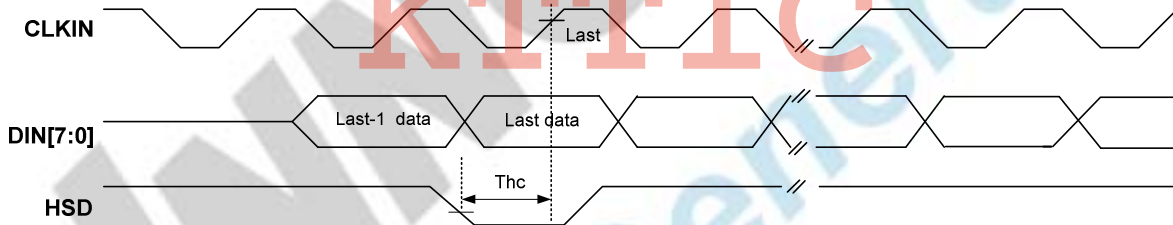
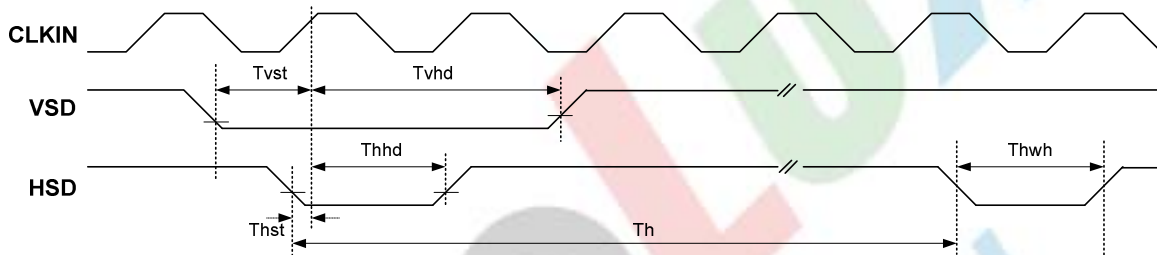
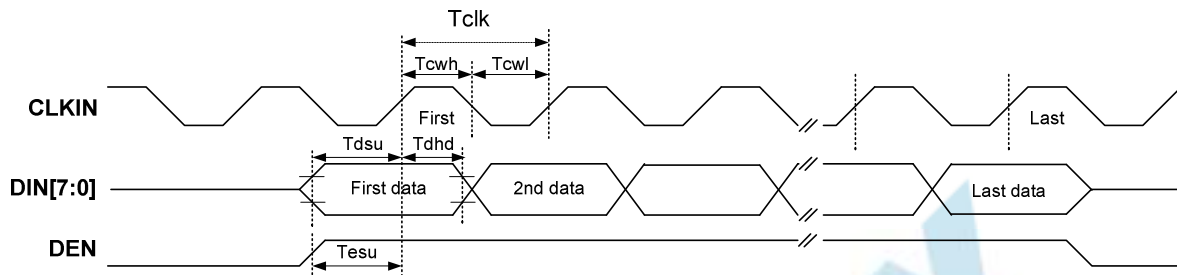

3-Wire Timing Diagram

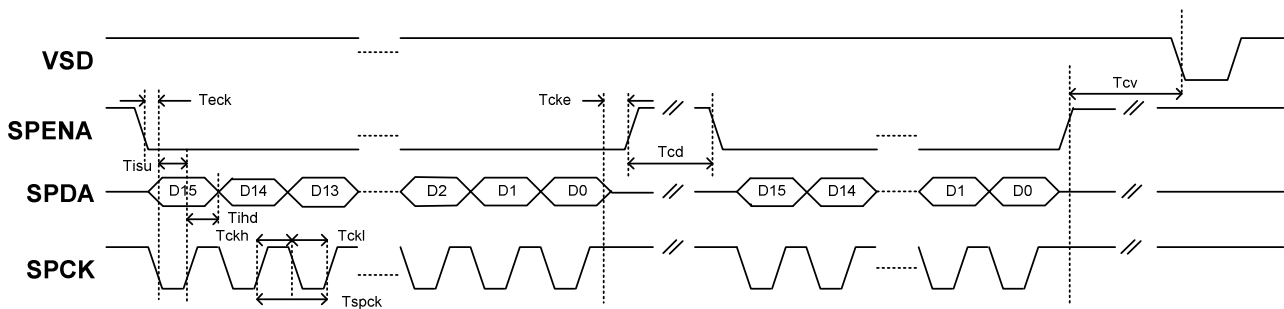

版權屬於群創所有，禁止任何未經授權的使用

The copyright belongs to InnoLux. Any unauthorized use is prohibited.

Note: 3-Wire Control Registers List

3-Wire Register		Register Description		
D[15:10]	Name	Init	R/W	Function Description
000000b	R00	(03h)	R/W	System control register
000001b	R01	(00h)	R/W	Timing controller function register
000010b	R02	(11h)	R/W	Operation control register
000011b	R03	(c4h)	R/W	Input data format control register
000100b	R04	(7ch)	R/W	Source Timing delay control register
000101b	R05	(0ch)	R/W	Gate Timing delay control register
000111b	R07	(03h)	R/W	Internal function control register
001000b	R08	(08h)	R/W	RGB contrast control register
001001b	R09	(40h)	R/W	RGB brightness control register
001010b	R0A	(88h)	R/W	Hue/Saturation control register
001011b	R0B	(88h)	R/W	R/B Sub-contrast control register
001100b	R0C	(20h)	R/W	R Sub-brightness control register
001101b	R0D	(20h)	R/W	B Sub-brightness control register

4. Optical Specifications

Item	Symbol	Condition	Min.	Typ.	Max.	Unit	Remark
Viewing angle (CR≥10)	θ_L	$\Phi=180^\circ$ (9 o'clock)	55	60	-	degree	Note 1
	θ_R	$\Phi=0^\circ$ (3 o'clock)	55	60	-		
	θ_T	$\Phi=90^\circ$ (12 o'clock)	35	40	-		
	θ_B	$\Phi=270^\circ$ (6 o'clock)	55	60	-		
Response Time	T_{ON}	Normal $\theta=\Phi=0^\circ$	-	15	30	msec	Note 3
	T_{OFF}		-	20	50	msec	Note 3
Contrast ratio	CR		200	300	-	-	Note 4
Color chromaticity	W_X		-	TBD	-	-	Note 5
	W_Y		-	TBD	-	-	Note 6
Luminance	L		200	250	-	cd/m ²	Note 6
Luminance uniformity	Y_U		70	75	-	%	Note 7

Test Conditions:

1. $V_{CC}=3.3V$, $AV_{DD}=5.0V$, $I_L=20mA$ (Backlight current), the ambient temperature is $25^\circ C$.
2. The test systems refer to Note 2.

Note 1: Definition of viewing angle range

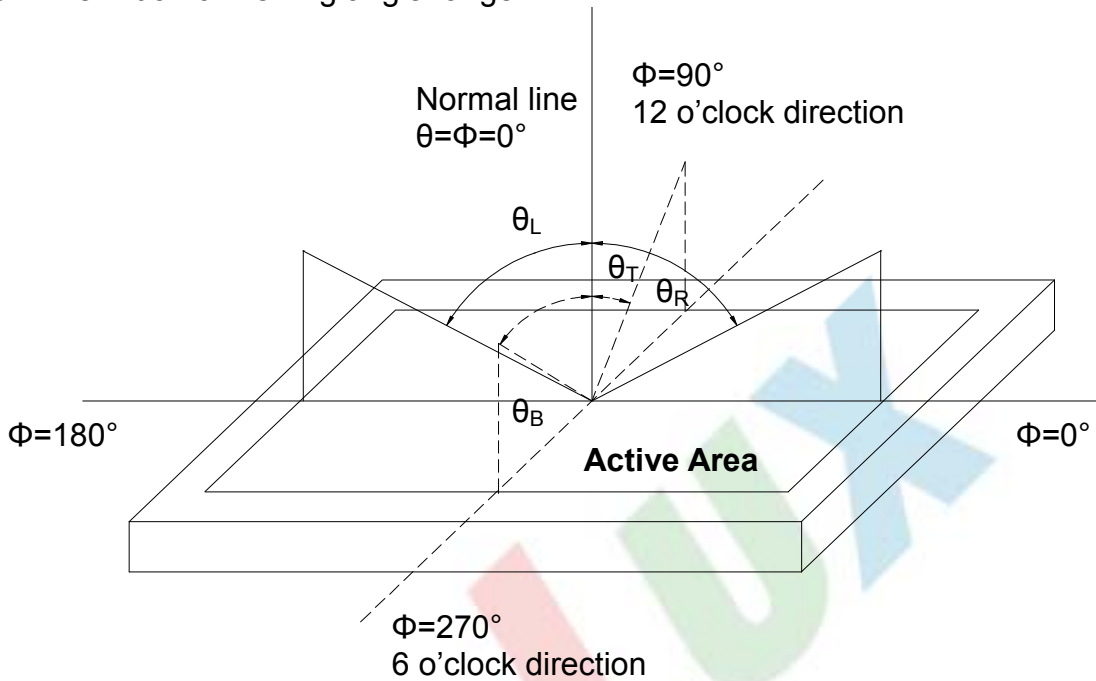

Fig. 4-1 Definition of viewing angle

Note 2: Definition of optical measurement system. (TFT)

The optical characteristics should be measured in dark room, the optical properties are measured at the center point of the LCD screen. (Response time is measured by Photo detector TOPCON BM-7, other items are measured by BM-5A/Field of view: 1° /Height: 500mm.)

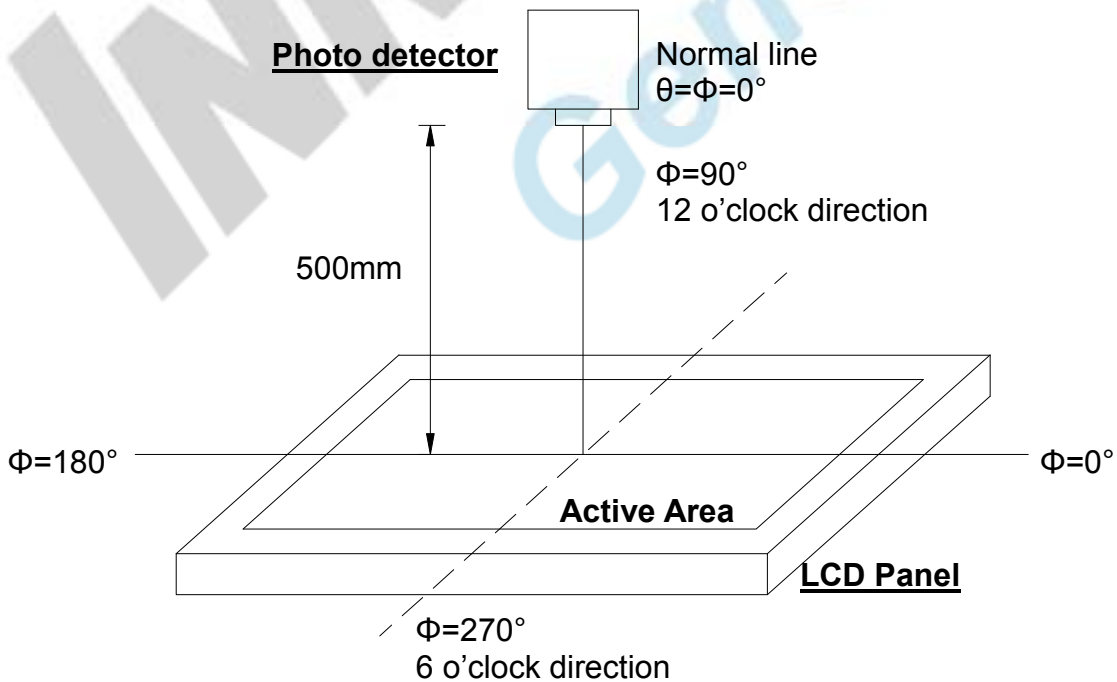

Fig. 4-2 Optical measurement system setup

Note 3: Definition of Response time

The response time is defined as the LCD optical switching time interval between "White" state and "Black" state. Rise time (T_{ON}) is the time between photo detector output intensity changed from 90% to 10%. And fall time (T_{OFF}) is the time between photo detector output intensity changed from 10% to 90%.

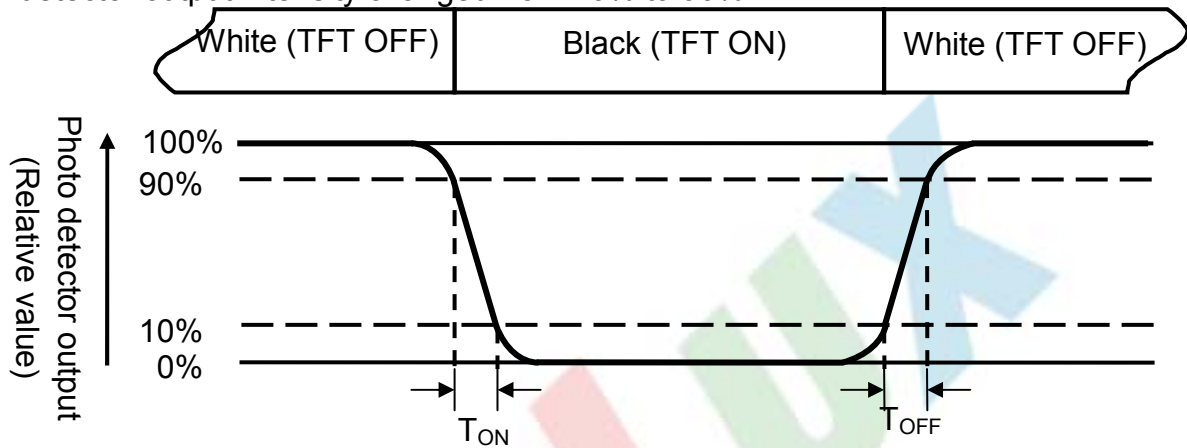

Fig. 4-3 Definition of response time

Note 4: Definition of contrast ratio

$$\text{Contrast ratio (CR)} = \frac{\text{Luminance measured when LCD is on the "White" state}}{\text{Luminance measured when LCD is on the "Black" state}}$$

Note 5: Definition of color chromaticity (CIE1931)

Color coordinates measured at center point of LCD.

Note 6: All input terminals LCD panel must be ground when measuring the center area of the panel.

Note 7: Definition of Luminance Uniformity

To test for uniformity, the tested area, which is inside the active area, is divided into 3 rows and 3 columns. The measurement spot is placed at the center of each box.

$$\text{Luminance Uniformity (Yu)} = \frac{B_{min}}{B_{max}}$$

L-----Active area length W----- Active area width

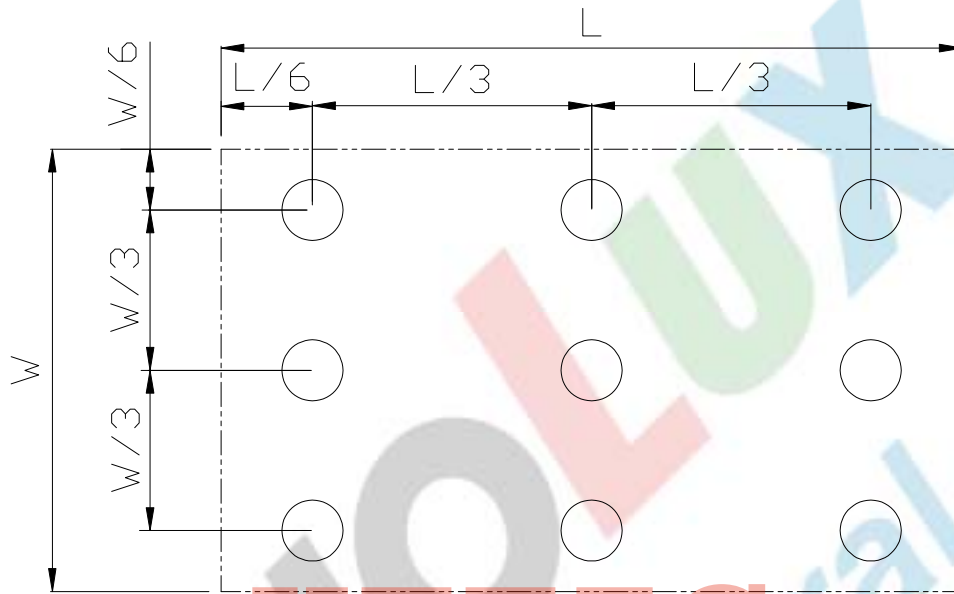

Fig. 4-4 Definition of uniformity

B_{max}: The measured maximum luminance of all measurement position.

B_{min}: The measured minimum luminance of all measurement position.

6. Handling Precautions

6.1. Safety

Liquid crystal is poisonous. Do not put it in your mouth. If liquid crystal touches your skin or clothes, wash it off immediately by using soap and water.

6.2. Handling

1. The LCD panel is plate glass. Do not subject the panel to mechanical shock or to excessive force on its surface.
2. The polarizer attached to the display is easily damaged. Please handle it carefully to avoid scratch or other damages.
3. To avoid contamination on the display surface, do not touch the module surface with bare hands.
4. Keep space so that the LCD panels do not touch other components.
5. Put cover board such as acrylic board on the surface of LCD panel to protect panel from damages.
6. Transparent electrodes may be disconnected if you use the LCD panel under environmental conditions where the condensation of dew occurs.
7. Do not leave module in direct sunlight to avoid malfunction of the ICs.

6.3. Static Electricity

1. Be sure to ground module before turning on power or operating module.
2. Do not apply voltage which exceeds the absolute maximum rating value.

6.4. Storage

1. Store the module in a dark room where must keep at $+25\pm 10^{\circ}\text{C}$ and 65%RH or less.
2. Do not store the module in surroundings containing organic solvent or corrosive gas.
3. Store the module in an anti-electrostatic container or bag.

6.5. Cleaning

1. Do not wipe the polarizer with dry cloth. It might cause scratch.
2. Only use a soft sloth with IPA to wipe the polarizer, other chemicals might permanent damage to the polarizer.

7. Mechanical Drawing

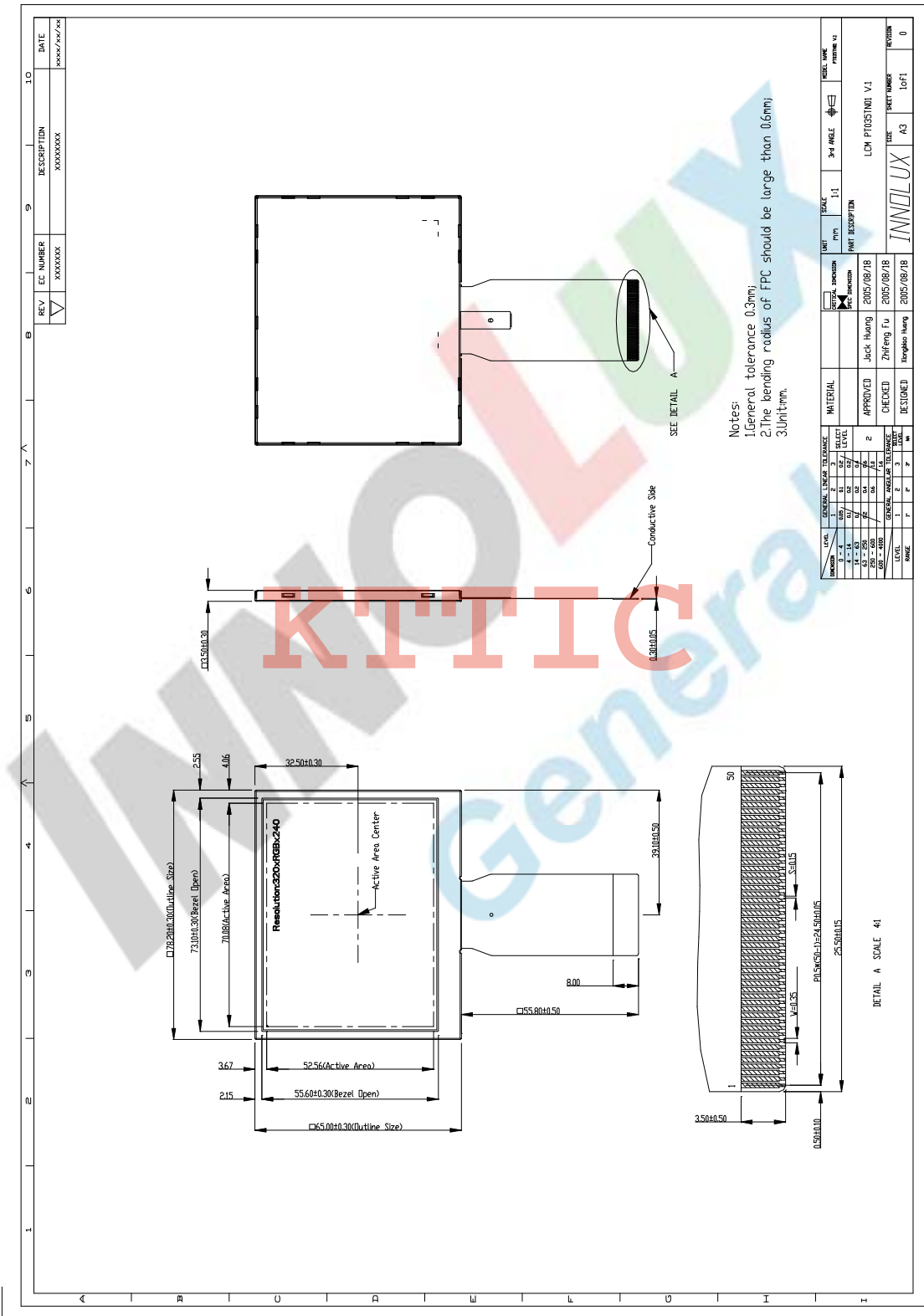

版權屬於群創所有，禁止任何未經授權的使用

8. Package Drawing

8.1. Packaging Material Table

No.	Item	Model (Material)	Dimensions(mm)	Unit Weight(Kg)	Quantity	Remark
1	LCM Module	PT035TN01 V.1	78.2×65.0×3.5	TBD	260pcs	
2	Partition	B Corrugated paper	104×349	TBD	12pcs	
3	Corrugated Board	B Corrugated paper	510×350	0.144	3pcs	
4	Partition Paper	BC Corrugated paper	512×349×106	TBD	2pcs	
5	Dust-Proof Bag	PE	700×530	0.0604	1pcs	
6	A/S Bag	PE	127×87.0×0.1	TBD	260pcs	
7	Carton	Corrugated paper	530×355×255	1.100	1pcs	
8	Total Weight	TBD				

8.2. Packaging Quantity

LCM quantity per tray: 2 row × 21 column + 4 row × 22 column = 130

Total LCM quantity in Carton: 2 × quantity per tray = 260

8.3. Packaging Drawing

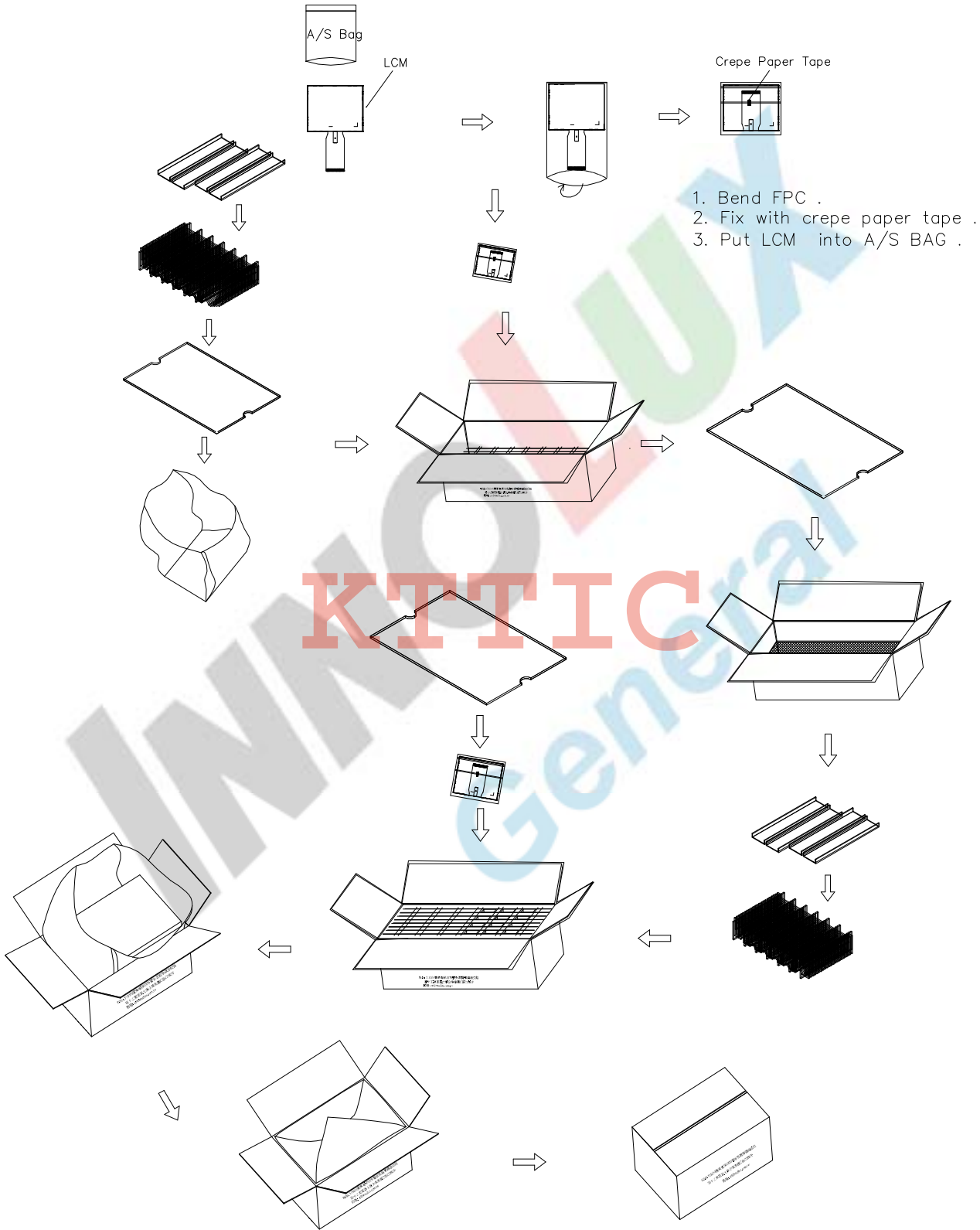

版權屬於群創所有，禁止任何未經授權的使用

The copyright belongs to InnoLux. Any unauthorized use is prohibited.

KTTIC <http://www.kttic.com>

KTTIC

<http://www.kttic.com>