

INNOLUX DISPLAY CORPORATION
LCD MODULE
SPECIFICATION

Customer: _____
Model Name: AT070TN07 V.2
SPEC NO.: A070-07-TT-25
Date: 2007/06/12
Version: 05

- Preliminary Specification
- Final Specification

For Customer's Acceptance

Approved by	Comment

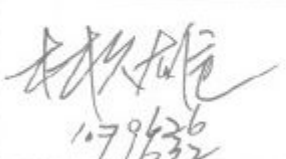
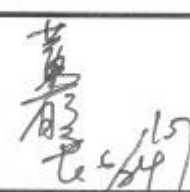
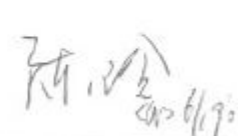
Approved by	Reviewed by	Prepared by
 1079626 1071632	 1079626	 2007/6/12

Record of Revision

Version	Revise Date	Page	Content
Final Spec. 01	2006/01/09		
02	2006/06/28	2,3 6 8	Modify the symbol of FPC Pin assignment. Add the notes 5. Add the power sequence.
03	2007/01/08	12~13 2 4 5 6 7 8 18 20 22	Modify the timing diagram. Add FPC connector type Add LED connector type Add LED reverse voltage & forward current Add note 4 Modify Vcc values Modify note 5 Modify note 3 Update power sequence Add note to power sequence Modify note 6 Add note 4 Add FPC connector type & modify label's location
04	2007/03/01	9	Modify Timing conditions, including vales of rising time, falling time, high and low level pulse width, OEH pulse width, sample and hold disable time, OEV pulse width, CKV pulse width, clean enable time, horizontal display timing range
05	2007/06/12	16	Modify the luminance from "450 cd/m ² " to "500 cd/m ² ".

Contents:

1. General Specifications	1
2. Pin Assignment	2
2.1. TFT LCD Panel Driving Section	2
2.2. Backlight Unit Section	4
3. Operation Specifications	5
3.1. Absolute Maximum Rating	5
3.1.1. Typical Operation Conditions	6
3.1.2. Current Consumption	7
3.1.3. Backlight Driving Conditions	7
3.2. Power Sequence	8
3.3. Timing Characteristics	9
3.3.1. Timing Conditions	9
3.3.2. Timing Diagram	11
4. Optical Specifications	16
5. Reliability Test Items	20
6. General Precautions	20
6.1. Safety	21
6.2. Handling	21
6.3. Static Electricity	21
6.4. Storage	21
6.5. Cleaning	21
7. Mechanical Drawing	22
8. Package Drawing	23
8.1. Packaging Material Table	23
8.2. Packaging Quantity	23
8.3. Packaging Drawing	24

1. General Specifications

No.	Item	Specification	Remark
1	LCD size	7.0 inch	
2	Driver element	a-Si TFT active matrix	
3	Resolution	480X3(RGB)X234	
4	Display mode	Normally White, Transmissive	
5	Dot pitch	0.107(W)X0.370(H) mm	
6	Active area	154.08(W)X86.58(H) mm	
7	Module size	164.9(W)X100.0(H)X5.7(D) mm	Note 1
8	Surface treatment	Anti-Glare	
9	Color arrangement	RGB-stripe	
10	Interface	Analog	
11	Backlight power consumption	1.78W (Typ.)	
12	Panel power consumption	111mW (Typ.)	
13	Weight	167g (Typ.)	

Note 1: Refer to Mechanical Drawing.

2. Pin Assignment

2.1. TFT LCD Panel Driving Section

FPC Connector is used for the module electronics interface. The recommended model is FH19S-26S-0.5SH (51) manufactured by Hirose.

Pin No.	Symbol	I/O	Function	Remark
1	GND	P	Ground	
2	V _{CC}	P	Supply voltage for scan driver	
3	V _{GL}	P	Negative power for scan driver	
4	V _{GH}	P	Positive power for scan driver	
5	STVD	I/O	Vertical start pulse	Note 1
6	STVU	I/O	Vertical start pulse	Note 1
7	CKV	I	Shift clock input for scan driver	
8	U/D	I	UP/DOWN scan control input	Note 1, 2
9	OEV	I	Output enable control for scan driver	
10	V _{COM}	I	Common electrode driving signal	
11	V _{COM}	I	Common electrode driving signal	
12	L/R	I	LEFT/RIGHT scan control input	Note 1, 2
13	MOD	I	Sequential sampling and simultaneous sampling setting	
14	OEH	I	Output enable control for data driver	
15	STHL	I/O	Start pulse for horizontal scan line	Note 1
16	STHR	I/O	Start pulse for horizontal scan line	Note 1
17	CPH3	I	Sampling and shifting clock pulse for data driver	
18	CPH2	I	Sampling and shifting clock pulse for data driver	
19	CPH1	I	Sampling and shifting clock pulse for data driver	

版權屬於群創所有，禁止任何未經授權的使用

20	V _{CC}	P	Supply voltage for scan driver	
21	GND	P	Ground	
22	V _R	I	Alternated video signal (Red)	
23	V _G	I	Alternated video signal (Green)	
24	V _B	I	Alternated video signal (Blue)	
25	AV _{DD}	P	Supply voltage for analog circuit	
26	AV _{SS}	P	Ground for analog circuit	

I: input, O: output, P: Power

Note 1: Selection of scanning mode

Setting of scan control input		IN/OUT state for start pulse				Scanning direction
U/D	L/R	STVD	STVU	STHR	STHL	
GND	V _{CC}	O	I	O	I	Up to down, left to right
V _{CC}	GND	I	O	I	O	Down to up, right to left
GND	GND	O	I	I	O	Up to down, right to left
V _{CC}	V _{CC}	I	O	O	I	Down to up, left to right

Note 2: Definition of scanning direction.
Refer to the figure as below:

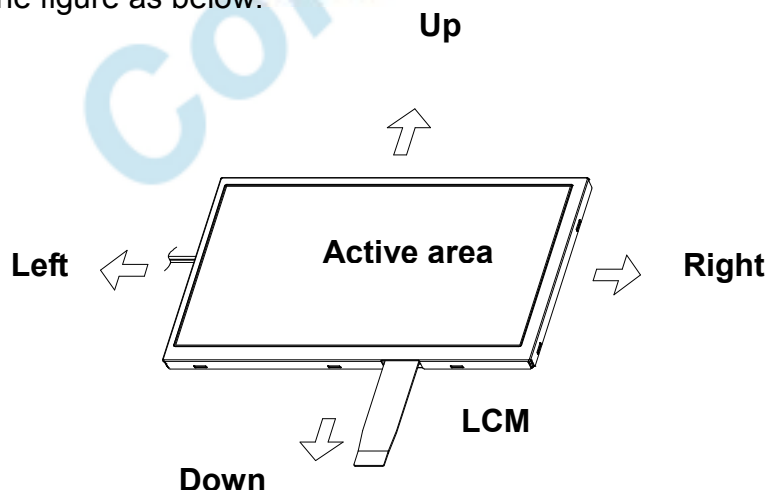

Note 3: MOD=H: Simultaneous sampling.
MOD=L: Sequential sampling.
Please set CPH2 and CPH3 to GND when MOD=H.

版權屬於群創所有，禁止任何未經授權的使用

2.2. Backlight Unit Section

LED Light Bar Connector is used for the integral backlight system.
The recommended model is BHSR-02VS-1 manufactured by JST.

Pin No.	Symbol	I/O	Function	Remark
1	HI	P	Power supply for backlight unit	Pink
2	GND	P	Ground for backlight unit	White

KTTIC

3. Operation Specifications

3.1. Absolute Maximum Rating

(Note 3)

Item	Symbol	Values		Unit	Remark
		Min.	Max.		
Power voltage	V_{CC}	-0.3	7	V	
	AV_{DD}	-0.3	7	V	
	V_{GH}	-0.3	18	V	
	V_{GL}	-15	0.3	V	
	$V_{GH}-V_{GL}$	-	33	V	
Input signal voltage	V_i	-0.2	$AV_{DD}+0.2$	V	Note 1
	V_i	-0.3	$V_{CC}+0.3$	V	Note 2
Operation temperature	T_{OP}	-30	85	°C	
Storage temperature	T_{ST}	-30	85	°C	
LED Reverse Voltage	V_R	-	1.2	V	Each LED
LED Forward Current	I_F	-	25	mA	Each LED

Note 1: V_R , V_G , V_B .

Note 2: STHL, STHR, OEH, L/R, CPH1~CPH3, STVR, STVL, OEV, CKV, U/D.

Note 3: The absolute maximum rating values of the module should not be exceeded.

Once exceeded absolute maximum rating values, the characteristics of the module may not be recovered. Even in an extreme condition, may result in module permanently destroyed.

Note 4: V_R Conditions: Zener Diode 20mA.

3.1.1. Typical Operation Conditions

(Note 4)

Item	Symbol	Values			Unit	Remark
		Min.	Typ.	Max.		
Power voltage	V _{CC}	3.1	3.3	3.5	V	Note 5
		4.8	5	5.2		
	AV _{DD}	4.8	5	5.2	V	
	V _{GH}	14.3	15	15.7	V	
	V _{GL}	-10.5	-10	-9.5	V	
Video signal amplitude (V _R , V _G , V _B)	V _{iA}	0.2	-	AV _{DD} -0.2	V	Note 1
	V _{iAC}	-	3	-	V	AC component
	V _{iDC}	-	AV _{DD} /2	-	V	DC component
V _{COM}	V _{CAC}	3.5	5.6	6.5	V	Note 2
	V _{CDC}	1.55	1.75	1.95	V	DC component
Input logic high voltage	V _{IH}	0.8V _{CC}	-	V _{CC}	V	Note 3
Input logic low voltage	V _{IL}	0	-	0.2V _{CC}	V	

Note 1: Refer to Fig.3-3-(a).

Note 2: The brightness of LCD panel could be changed by adjusting the AC component of V_{COM}.

Note 3: STHL, STHR, OEH, L/R, CPH1~CPH3, STVD, STVU, OEV, CKV, U/D.

Note 4: GND, V_{CC}, and V_{GL} are applied to LCD first and then V_{GH} is applied.

Note 5: V_{CC} setting should match the signals output voltage (refer to Note 3) of customer's system board.

Item	Min.	Max.	Unit
Signal High Level (VCC=5V)	4	5	V
Signal Low Level (VCC=5V)	0	1	V
Signal High Level (VCC=3.3V)	2.5	3.3	V
Signal Low Level (VCC=3.3V)	0	0.6	V

3.1.2. Current Consumption

Item	Symbol	Values			Unit	Remark
		Min.	Typ.	Max.		
Current for Driver	I_{GH}	-	0.2	0.5	mA	$V_{GH} = 15.0V$
	I_{GL}	-	0.8	1.5	mA	$V_{GL} = -10.0V$
	I_{CC}	-	3.0	6.0	mA	$V_{CC} = 5.0V$
	I_{DD}	-	17	30	mA	$AV_{DD} = 5.0V$

3.1.3. Backlight Driving Conditions

Item	Symbol	Values			Unit	Remark
		Min.	Typ.	Max.		
LED forward voltage	V_L	9.3	9.9	10.5	V	Note 2, 3
LED forward current	I_L	18	20	22	mA	Note 3
LED life time	-	20,000	-	-	Hr	Note 1

Note 1: The "LED life time" is defined as the module brightness decrease to 50% original brightness that the ambient temperature is 25°C and $I_L = 20mA$. The LED lifetime could be decreased if operating I_L is larger than 20 mA.

Note 2: The LED Supply Voltage is defined by the number of LED at $T_a = 25^\circ C$ and $I_L = 20mA$. In the case of 3pcs LED, $V_L = 3.3 * 3 = 9.9V$.

Note 3: The LED driving condition is defined for each LED module. (3 LED Serial)

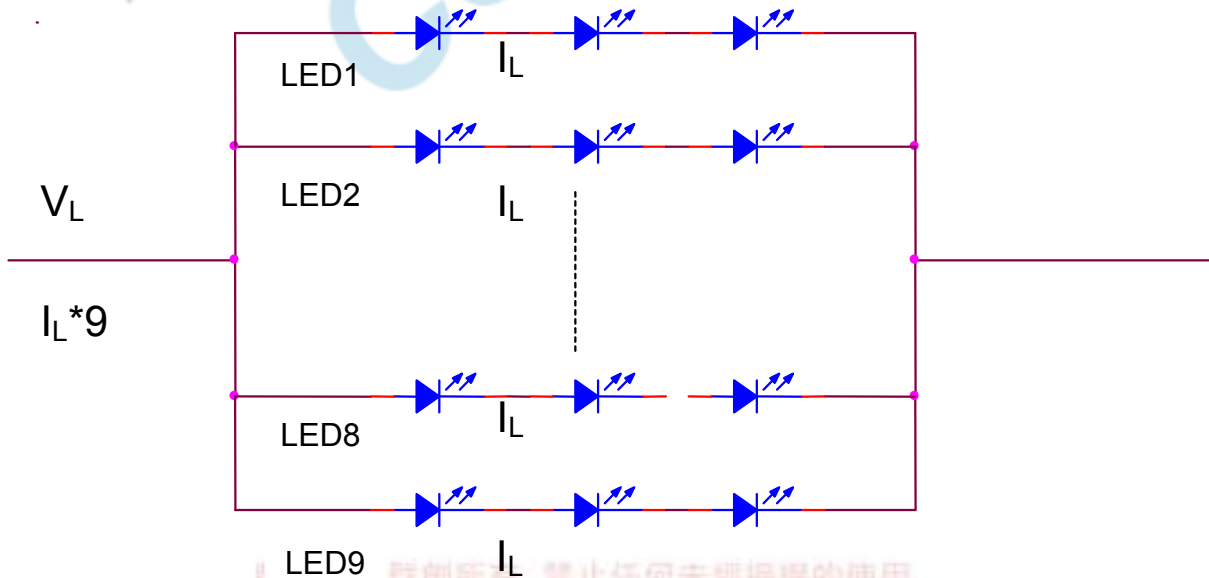

3.2. Power Sequence

3.2.1. Power on:

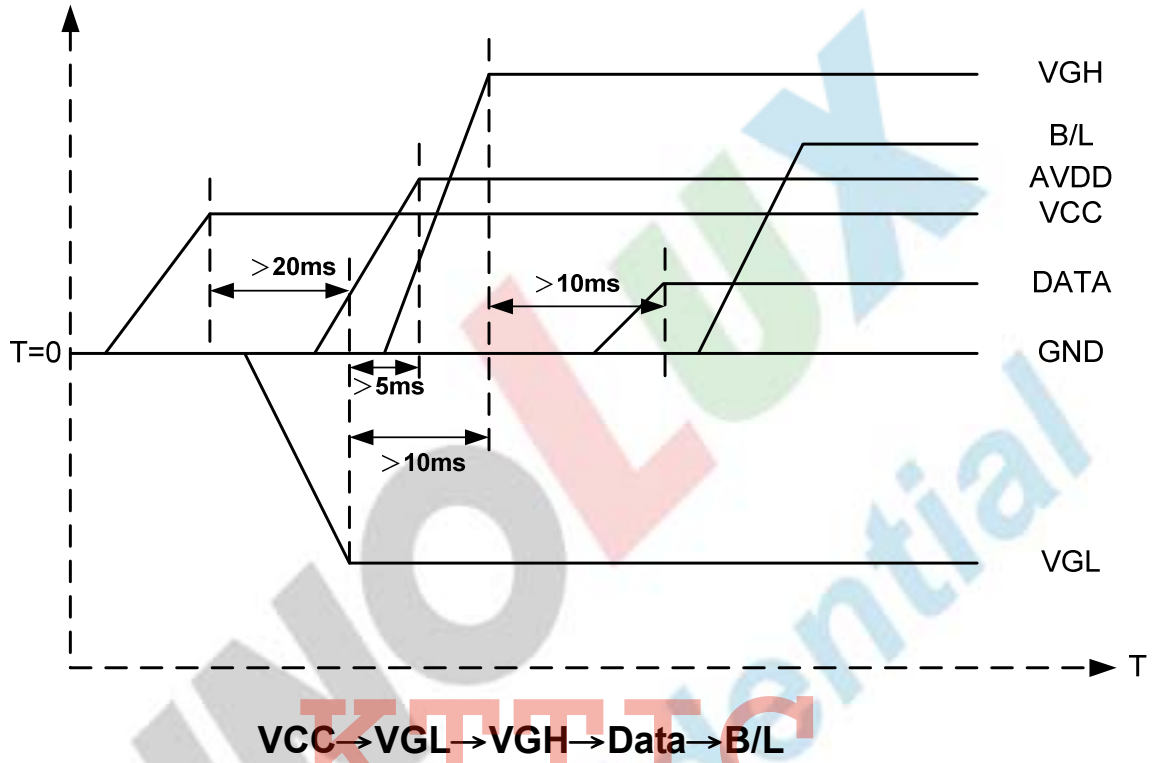

3.2.2. Power off:

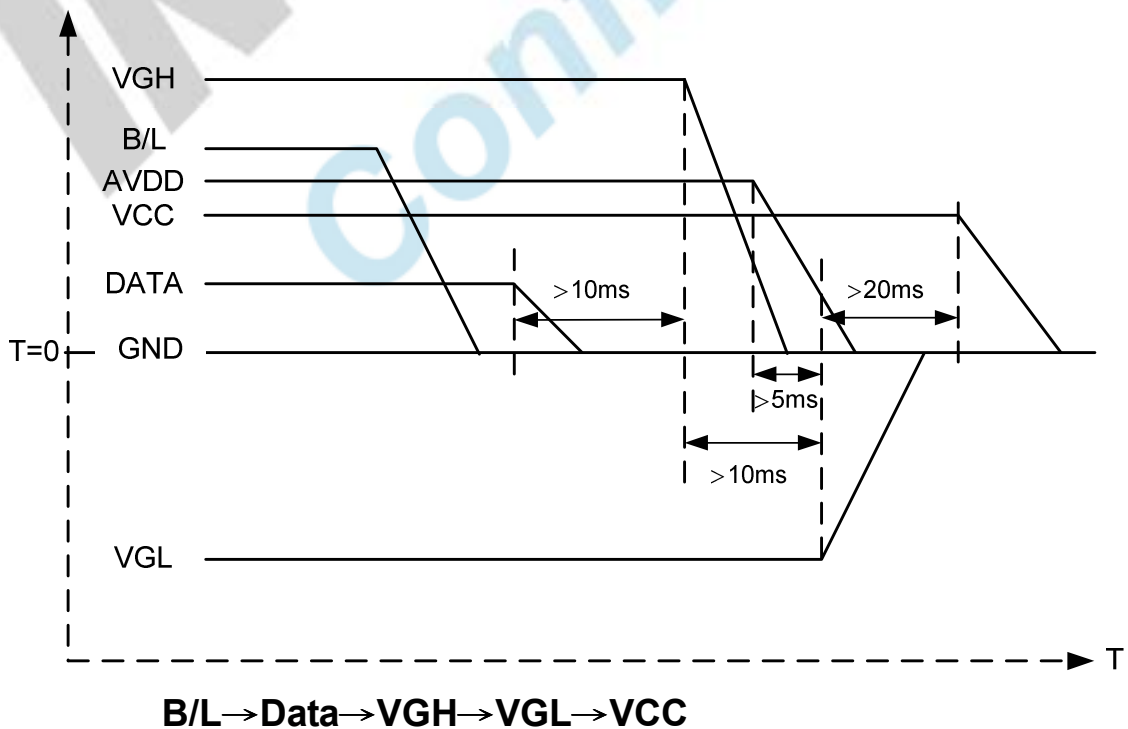

Note: Data include: STVD, STVU, CKV, OEH, STHL, STHR, CPH3, CPH2, CPH1, V_R, V_G, V_B.

3.3. Timing Characteristics

3.3.1. Timing Conditions

Item	Symbol	Values			Unit	Remark
		Min.	Typ.	Max.		
Rising time	t_r	-	-	10	ns	Note 1
Falling time	t_f	-	-	10	ns	Note 1
High and low level pulse width	t_{CPH}	99	103	107	ns	CPH1~CPH3
CPH pulse duty	t_{CWH}	40	50	60	%	CPH1~CPH3
CPH pulse delay	t_{C12}	30	$t_{CPH}/3$	$t_{CPH}/2$	ns	CPH1~CPH3
	t_{C23}					
	t_{C31}					
STH setup time	t_{SUH}	20	-	-	ns	STHR, STHL
STH hold time	t_{HDH}	20	-	-	ns	STHR, STHL
STH pulse width	t_{STH}	-	1	-	t_{CPH}	STHR, STHL
STH period	t_H	61.5	63.5	65.5	μs	STHR, STHL
OEH pulse width	t_{OEH}	-	1.22	-	μs	
Sample and hold disable time	t_{DIS1}	-	8.28	-	μs	
OEV pulse width	t_{OEV}	-	5.40	-	μs	
CKV pulse width	t_{CKV}	-	4.18	-	μs	
Clean enable time	t_{DIS2}	-	3.74	-	μs	
Horizontal display start	t_{SH}	-	0	-	$t_{CPH}/3$	
Horizontal display timing range	t_{DH}	-	1440	-	$t_{CPH}/3$	
STV setup time	t_{SUV}	400	-	-	ns	STVU, STVD
STV hold time	t_{HDV}	400	-	-	ns	STVU, STVD

版權屬於群創所有，禁止任何未經授權的使用

STV pulse width	t_{STV}	-	-	1	t_H	STVU, STVD
Horizontal lines per field	t_V	256	262	268	t_H	Note 2
Vertical display start	t_{SV}	-	3	-	t_H	
Vertical display timing range	t_{DV}	-	234	-	t_H	
V_{COM} rising time	t_{rCOM}	-	-	5	μs	
V_{COM} falling time	t_{fCOM}	-	-	5	μs	
V_{COM} delay time	t_{DCOM}	-	-	3	μs	
RGB delay time	t_{DRGB}	-	-	1	μs	

Note 1: For all of the logic signals

Note 2: Please don't use odd horizontal lines to drive LCD panel for both odd and even field simultaneously.

KTTIC

3.3.2. Timing Diagram

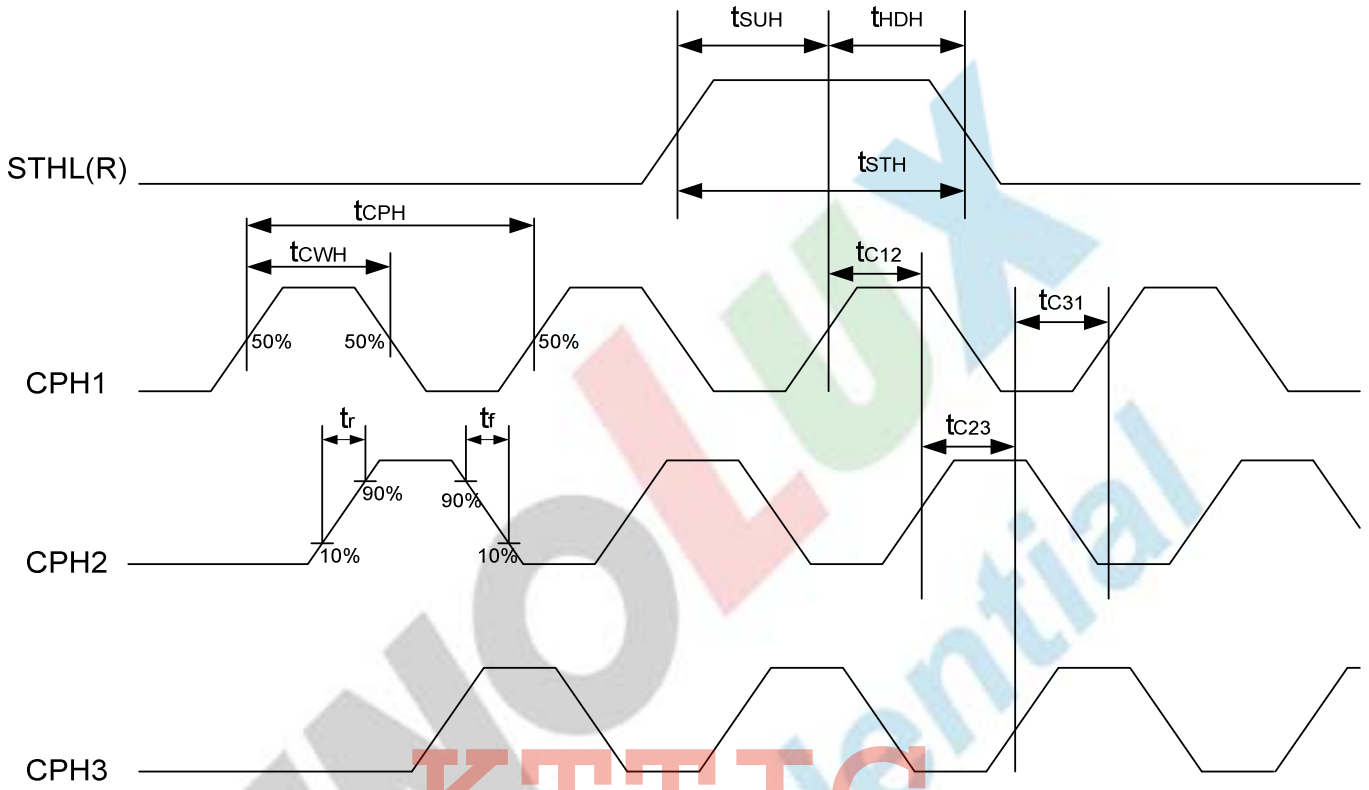

Fig.3-1 Sampling clock timing

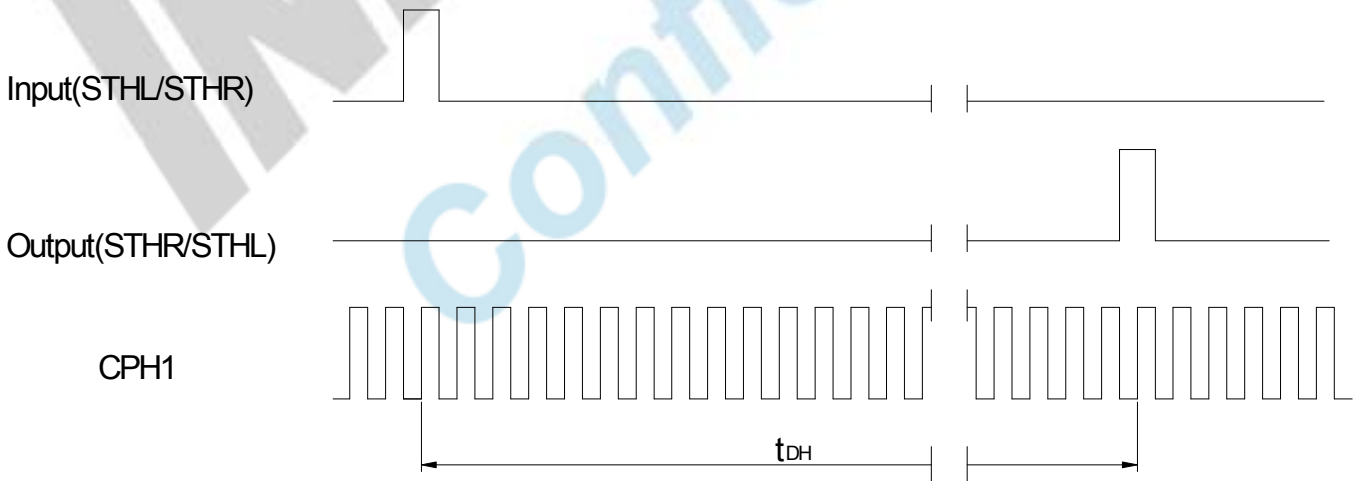

Fig.3-2 Horizontal display timing range

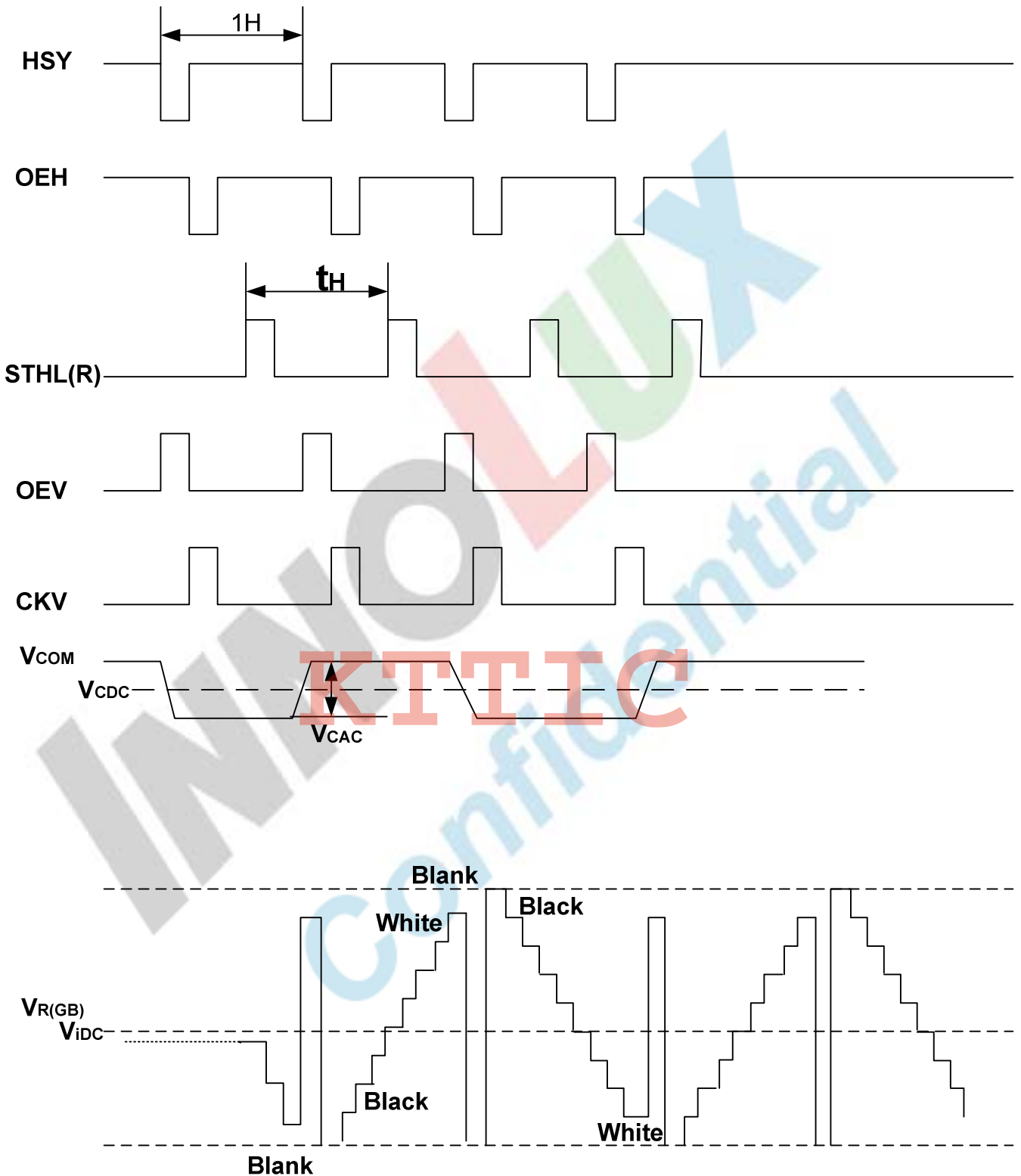

Fig.3-3-(a) Horizontal timing

版權屬於群創所有，禁止任何未經授權的使用

The copyright belongs to InnoLux. Any unauthorized use is prohibited.

<http://www.kttic.com>

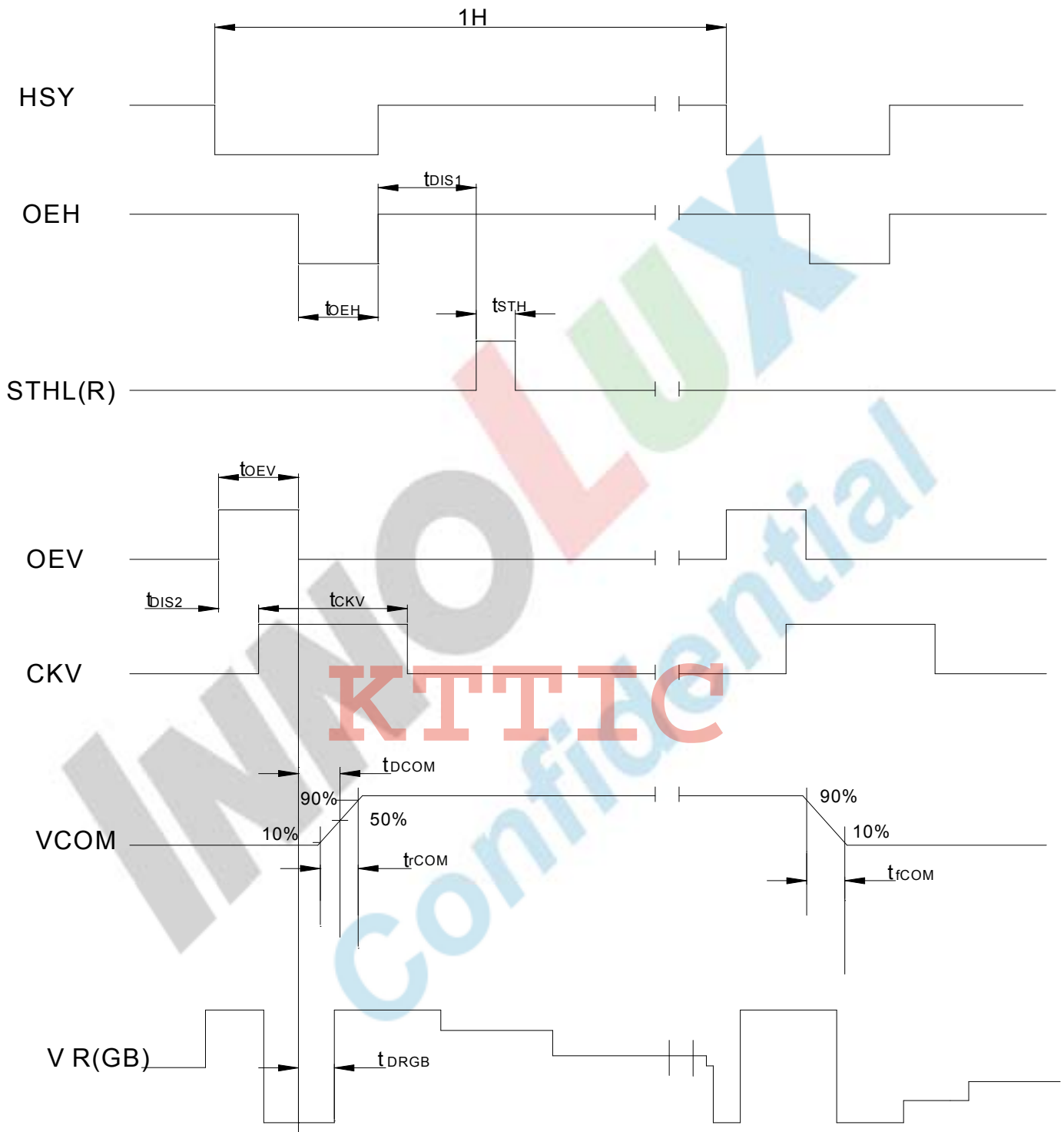

Fig.3-3-(b) Detail horizontal timing

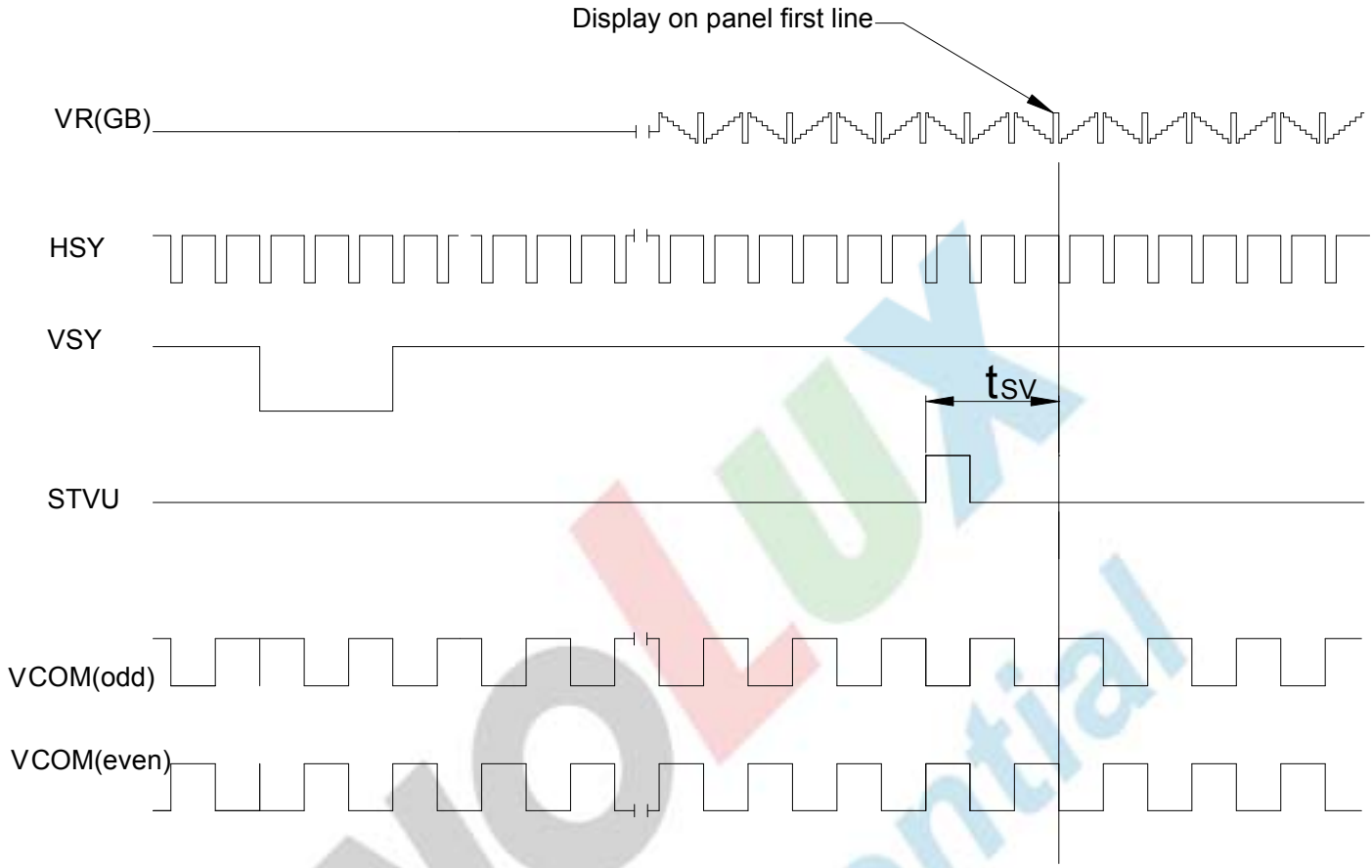

Fig.3-4(a) Vertical timing (from up to down)

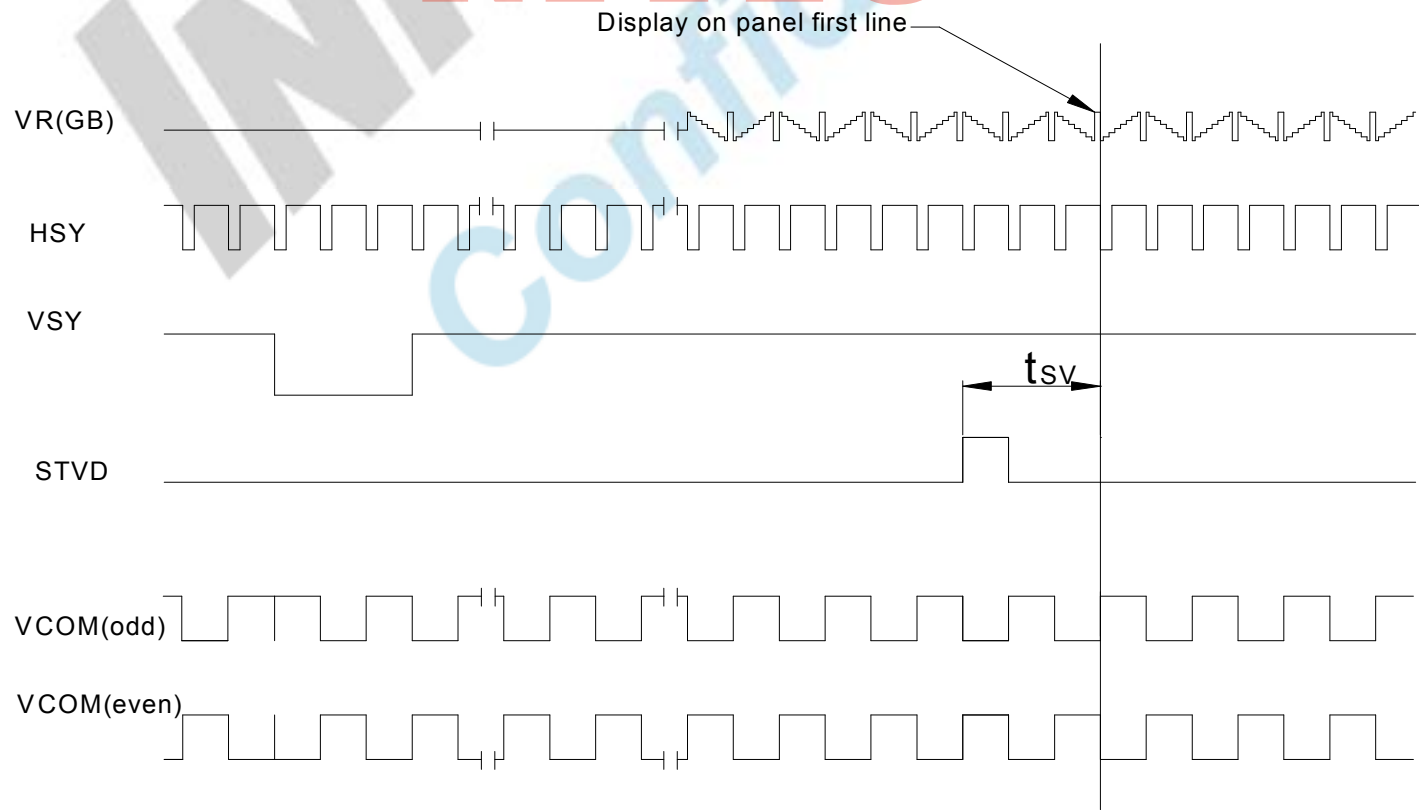

Fig.3-4(b) Vertical timing (from down to up)

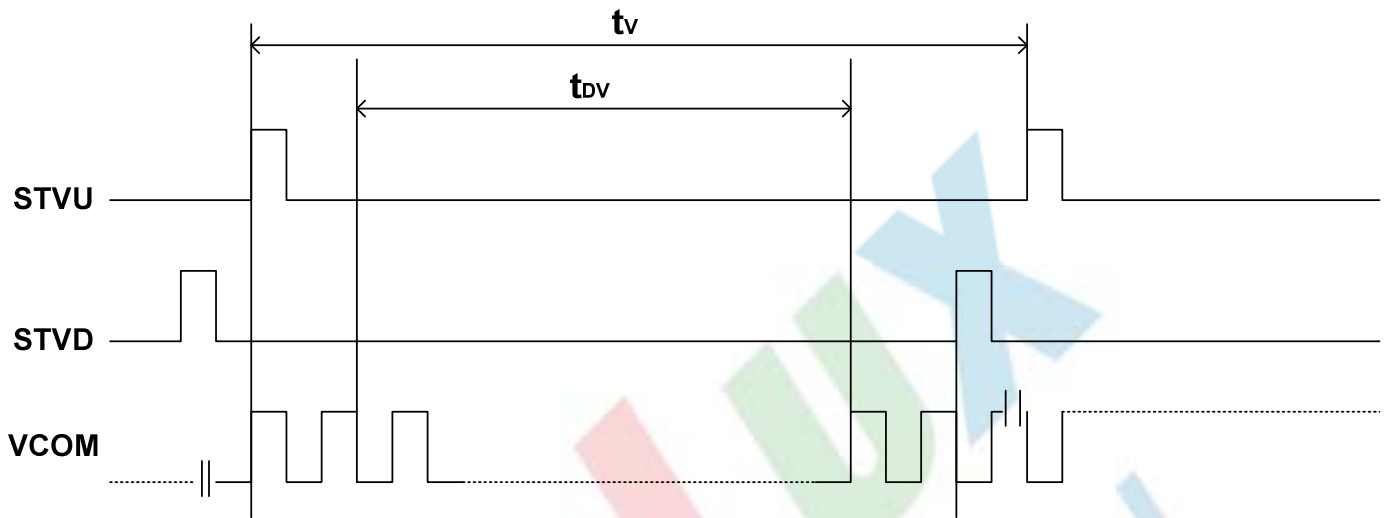

Fig.3-5 Vertical start pulse timing

KTTIC

4. Optical Specifications

Item	Symbol	Condition	Values			Unit	Remark
			Min.	Typ.	Max.		
Viewing angle (CR≥10)	θ_L	$\Phi=180^\circ$ (9 o'clock)	50	60	-	degree	Note 1
	θ_R	$\Phi=0^\circ$ (3 o'clock)	50	60	-		
	θ_T	$\Phi=90^\circ$ (12 o'clock)	30	40	-		
	θ_B	$\Phi=270^\circ$ (6 o'clock)	50	60	-		
Response time	T_{ON}	Normal $\theta=\Phi=0^\circ$	-	15	30	msec	Note 3
	T_{OFF}		-	20	40	msec	Note 3
Contrast ratio	CR		250	300	-	-	Note 4
Color chromaticity	W_X		0.26	0.31	0.36	-	Note 2 Note 5
	W_Y		0.28	0.33	0.38	-	Note 6
Luminance	L		450	500	-	cd/m ²	Note 6
Luminance uniformity	Y_U		70	75	-	%	Note 7

Test Conditions:

1. $V_{CC}=5V$, $AV_{DD}=5V$, $I_{LX9}=20mA \times 9=180$ mA (Backlight current), the ambient temperature is 25°C.
2. The test systems refer to Note 2.

Note 1: Definition of viewing angle range

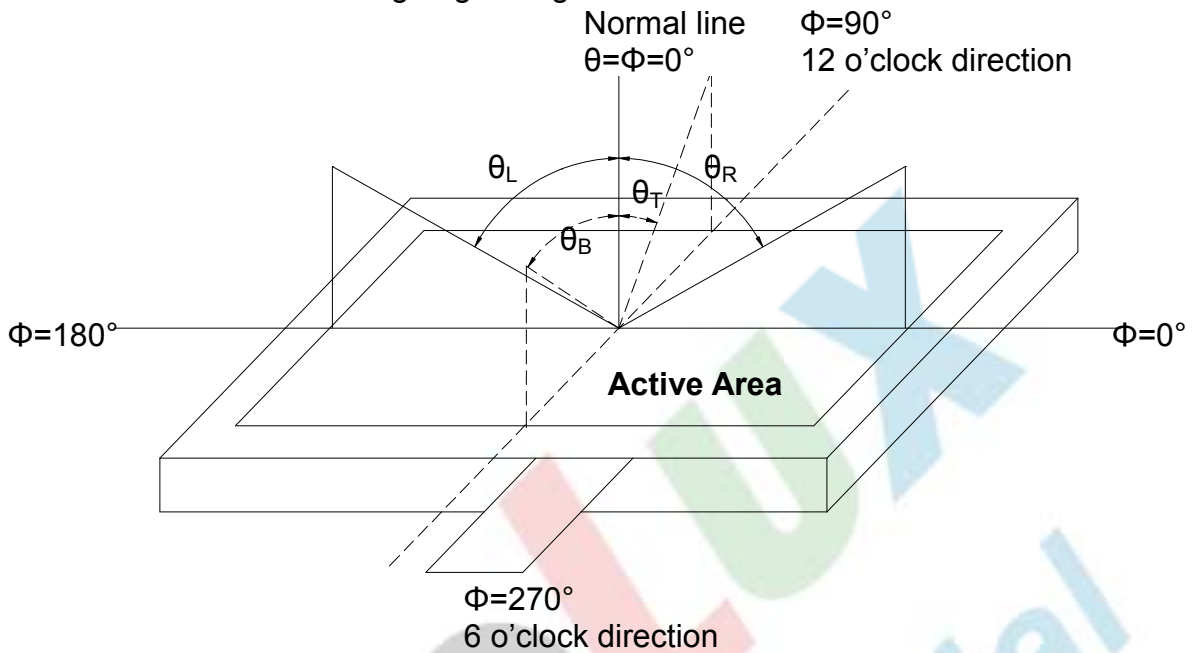

Fig. 4-1 Definition of viewing angle

Note 2: Definition of optical measurement system.

The optical characteristics should be measured in dark room. The optical properties are measured at the center point of the LCD screen. (Response time is measured by Photo detector TOPCON BM-7, other items are measured by BM-5A/Field of view: 1° /Height: 500mm.)

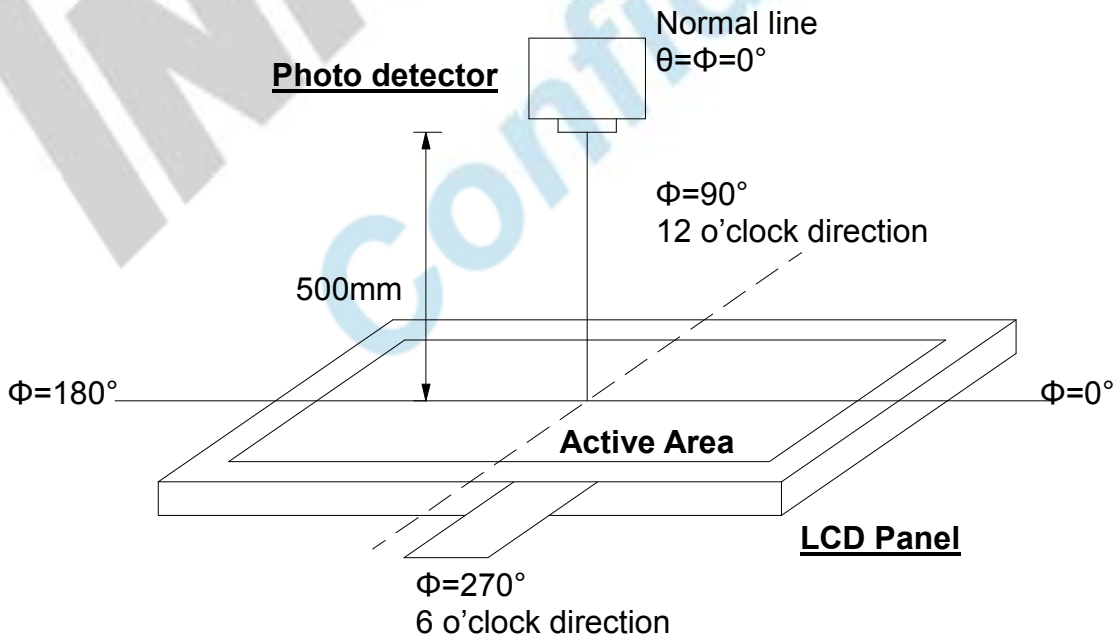

Fig. 4-2 Optical measurement system setup

版權屬於群創所有，禁止任何未經授權的使用

Note 3: Definition of Response time

The response time is defined as the LCD optical switching time interval between "White" state and "Black" state. Rise time (T_{ON}) is the time between photo detector output intensity changed from 90% to 10%. And fall time (T_{OFF}) is the time between photo detector output intensity changed from 10% to 90%.

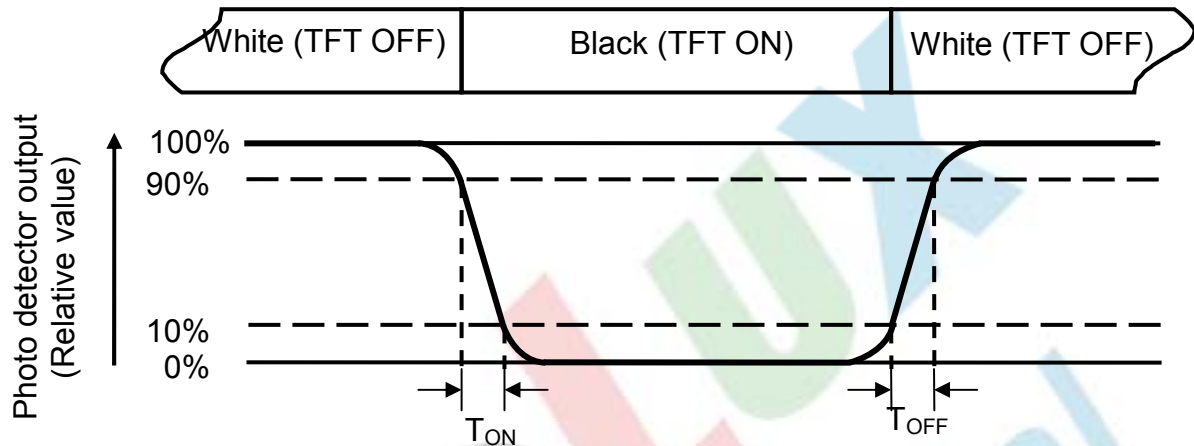

Fig. 4-3 Definition of response time

Note 4: Definition of contrast ratio

$$\text{Contrast ratio (CR)} = \frac{\text{Luminance measured when LCD is on the "White" state}}{\text{Luminance measured when LCD is on the "Black" state}}$$

$$\text{White } V_i = V_{i50\%} \pm 1.5 \text{ V}$$

$$\text{Black } V_i = V_{i50\%} \mp 2.0 \text{ V}$$

"±" means that the analog input signal swings in phase with V_{COM} signal.

"∓" means that the analog input signal swings out of phase with V_{COM} signal.

$V_{i50\%}$: The analog input voltage when transmission is 50%

The 100% transmission is defined as the transmission of LCD panel when all the input terminals of module are electrically opened.

Note 5: Definition of color chromaticity (CIE1931)

Color coordinates measured at center point of LCD.

Note 6: All input terminals LCD panel must be ground while measuring the center area of the panel. The LED driving condition is $I_L=20\text{mA}$ of which each LED module is 3 LED serial.

Note 7: Definition of Luminance Uniformity

Active area is divided into 9 measuring areas (Refer to Fig. 4-4).Every measuring point is placed at the center of each measuring area.

$$\text{Luminance Uniformity (Yu)} = \frac{B_{min}}{B_{max}}$$

L-----Active area length W----- Active area width

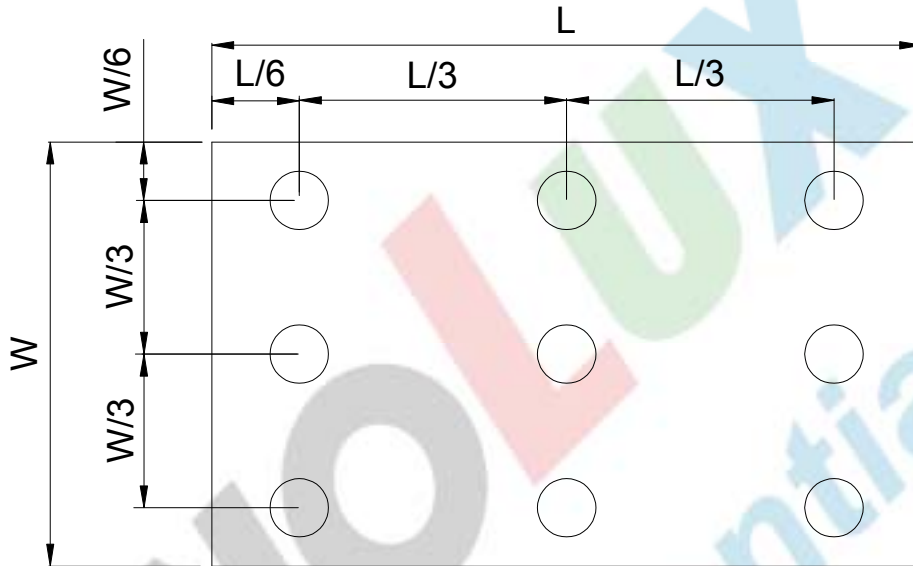

Fig. 4-4 Definition of measuring points

B_{max}: The measured maximum luminance of all measurement position.

B_{min}: The measured minimum luminance of all measurement position.

6. General Precautions

6.1. Safety

Liquid crystal is poisonous. Do not put it in your mouth. If liquid crystal touches your skin or clothes, wash it off immediately by using soap and water.

6.2. Handling

1. The LCD panel is plate glass. Do not subject the panel to mechanical shock or to excessive force on its surface.
2. The polarizer attached to the display is easily damaged. Please handle it carefully to avoid scratch or other damages.
3. To avoid contamination on the display surface, do not touch the module surface with bare hands.
4. Keep a space so that the LCD panels do not touch other components.
5. Put cover board such as acrylic board on the surface of LCD panel to protect panel from damages.
6. Transparent electrodes may be disconnected if you use the LCD panel under environmental conditions where the condensation of dew occurs.
7. Do not leave module in direct sunlight to avoid malfunction of the ICs.

6.3. Static Electricity

1. Be sure to ground module before turning on power or operating module.
2. Do not apply voltage which exceeds the absolute maximum rating value.

6.4. Storage

1. Store the module in a dark room where must keep at $+25\pm 10^{\circ}\text{C}$ and 65%RH or less.
2. Do not store the module in surroundings containing organic solvent or corrosive gas.
3. Store the module in an anti-electrostatic container or bag.

6.5. Cleaning

1. Do not wipe the polarizer with dry cloth. It might cause scratch.
2. Only use a soft sloth with IPA to wipe the polarizer, other chemicals might permanent damage to the polarizer.

7. Mechanical Drawing

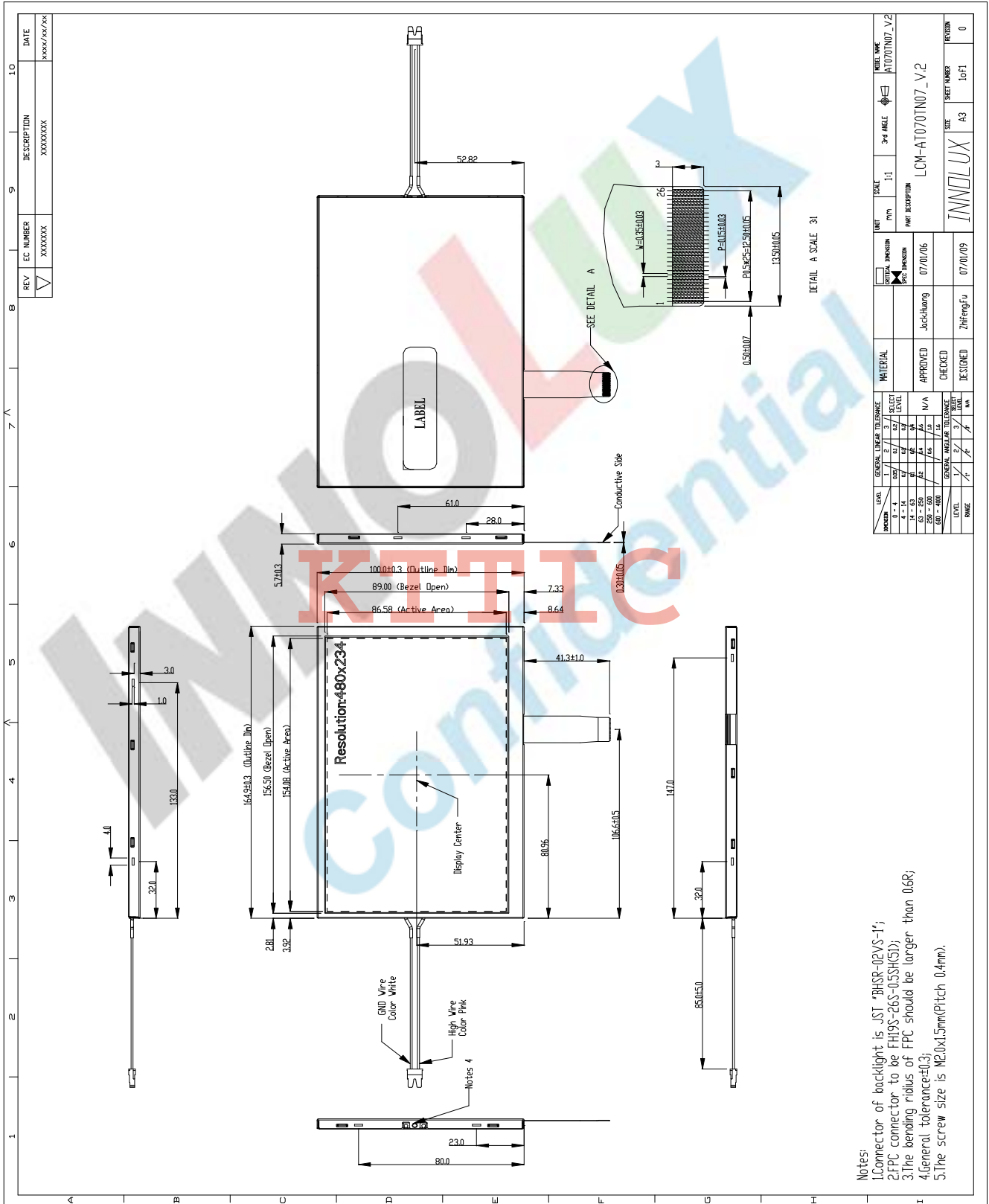

版權屬於群創所有，禁止任何未經授權的使用

The copyright belongs to InnoLux. Any unauthorized use is prohibited

8. Package Drawing

8.1. Packaging Material Table

No.	Item	Model (Material)	Dimensions(mm)	Unit Weight (kg)	Quantity	Remark
1	LCM Module	AT070TN07 V.2	164.9 X 100.0 X 5.7	0.167	50 pcs	
2	Partition	BC Corrugated paper	512 X 349 X 226	1.466	1 set	
3	Corrugated Bar	BC Corrugated paper	512X11X3	0.046	4 set	
4	Corrugated Board	BC Corrugated Paper	510 X 343	0.130	1pcs	
5	Dust-Proof Bag	PE	700X530	0.048	1 pcs	
6	A/S Bag	PE	180 X 133 X 0.2	0.002	50 pcs	
7	Carton	Corrugated paper	530 X 355 X 255	1.100	1 pcs	
8	Total weight	11.378± 5%Kg				

8.2. Packaging Quantity

Total LCM quantity in Carton: no. of Partition	2 Rows x	quantity per Row	25	= 50
--	----------	------------------	----	------

8.3. Packaging Drawing

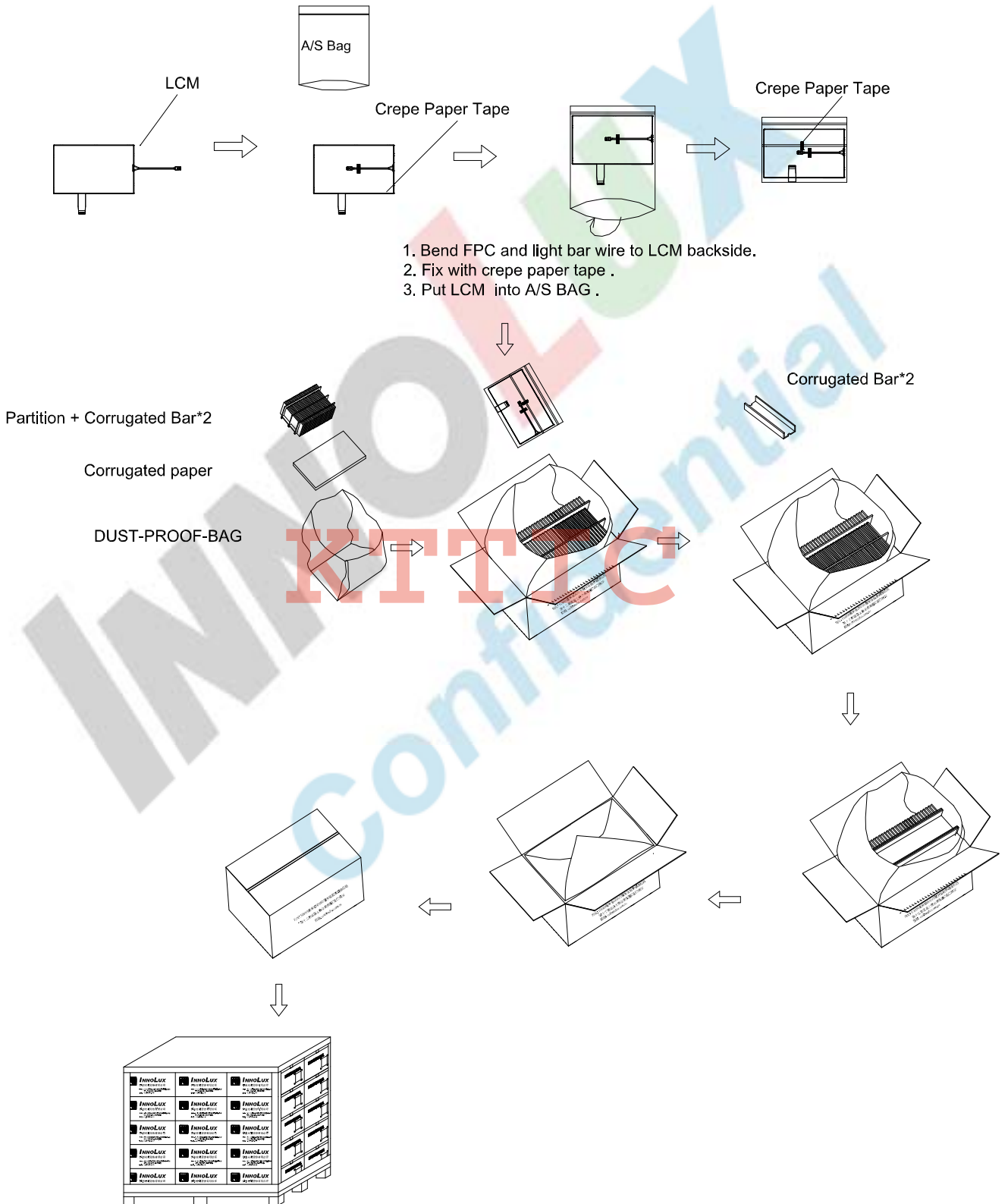

版權屬於群創所有，禁止任何未經授權的使用

The copyright belongs to InnoLux. Any unauthorized use is prohibited