

INNOLUX DISPLAY CORPORATION
LCD MODULE
SPECIFICATION

Customer: _____

Model Name: AT056TN04 V.1

SPEC NO.: A056-04-TT-12

Date: 2006/06/27

Version: 02

Preliminary Specification

Final Specification

For Customer's Acceptance

| Approved by | Comment |
|-------------|---------|
| | |

| Approved by | Reviewed by | Prepared by |
|-------------|-------------|-------------|
| | | |

106 0715
A 056 04

Record of Revision

| Version | Revise Date | Page | Content |
|---------|-------------|-------|----------------------------|
| 01 | 2006/03/29 | | Final specification. |
| 02 | 2006/06/27 | 6 | Add the note5. |
| | | 8 | Add the power sequence. |
| | | 12,13 | Modify the timing diagram. |

KTTIC

Contents:

| | |
|---|----|
| 1. General Specifications | 1 |
| 2. Pin Assignment | 2 |
| 2.1. TFT LCD Panel Driving Section | 2 |
| 2.2. Backlight Unit Section | 4 |
| 3. Operation Specifications | 5 |
| 3.1. Absolute Maximum Rating | 5 |
| 3.1.1. Typical Operation Conditions | 6 |
| 3.1.2. Current Consumption | 7 |
| 3.1.3. Backlight Driving Conditions | 7 |
| 3.2. Power Sequence | 8 |
| 3.3. Timing Characteristics | 9 |
| 3.3.1. Timing Conditions | 9 |
| 3.3.2. Timing Diagram | 11 |
| 4. Optical Specifications | 16 |
| 5. Reliability Test Items | 20 |
| 6. General Precautions | 21 |
| 6.1. Safety | 21 |
| 6.2. Handling | 21 |
| 6.3. Static Electricity | 21 |
| 6.4. Storage | 21 |
| 6.5. Cleaning | 21 |
| 7. Mechanical Drawing | 22 |
| 8. Package Drawing | 23 |
| 8.1. Packaging Material Table | 23 |
| 8.2. Packaging Quantity | 23 |
| 8.3. Packaging Drawing | 24 |

KTTIC

1. General Specifications

| No. | Item | Specification | Remark |
|-----|-----------------------------|------------------------------|--------|
| 1 | LCD size | 5.6inch(Diagonal) | |
| 2 | Driver element | a-Si TFT active matrix | |
| 3 | Resolution | 320X3(RGB)X234 | |
| 4 | Display mode | Normally white, Transmissive | |
| 5 | Dot pitch | 0.118(W)X0.362(H) mm | |
| 6 | Active area | 113.28(W)X84.708(H) mm | |
| 7 | Module size | 126.5(W)X100.0(H)X5.7(D) mm | Note 1 |
| 8 | Surface treatment | Anti-Glare | |
| 9 | Color arrangement | RGB-stripe | |
| 10 | Interface | Analog | |
| 11 | Backlight power consumption | 1.386W(Typ.) | |
| 12 | Panel power consumption | 86mW(Typ.) | |
| 13 | Weight | 129g | |

Note 1: Refer to Mechanical Drawing.

2. Pin Assignment

2.1. TFT LCD Panel Driving Section

| Pin No. | Symbol | I/O | Function | Remark |
|---------|------------------|-----|---|-----------|
| 1 | GND | P | Ground | |
| 2 | V _{CC} | P | Supply voltage for scan driver | |
| 3 | V _{GL} | P | Negative power for scan driver | |
| 4 | V _{GH} | P | Positive power for scan driver | |
| 5 | STVD | I/O | Vertical start pulse | Note 1 |
| 6 | STVU | I/O | Vertical start pulse | Note 1 |
| 7 | CKV | I | Shift clock input for scan driver | |
| 8 | U/D | I | UP/DOWN scan control input | Note 1, 2 |
| 9 | OEV | I | Output enable control for scan driver | |
| 10 | V _{COM} | I | Common electrode driving signal | |
| 11 | V _{COM} | I | Common electrode driving signal | |
| 12 | L/R | I | LEFT/RIGHT scan control input | Note 1, 2 |
| 13 | MOD | I | Sequential sampling and simultaneous sampling setting | |
| 14 | OEH | I | Output enable control for data driver | |
| 15 | STHL | I/O | Start pulse for horizontal scan line | Note 1 |
| 16 | STHR | I/O | Start pulse for horizontal scan line | Note 1 |
| 17 | CPH3 | I | Sampling and shifting clock pulse for data driver | |
| 18 | CPH2 | I | Sampling and shifting clock pulse for data driver | |
| 19 | CPH1 | I | Sampling and shifting clock pulse for data driver | |
| 20 | V _{CC} | P | Supply voltage for scan driver | |

| | | | | |
|----|------------------|---|-----------------------------------|--|
| 21 | GND | P | Ground | |
| 22 | V _R | I | Alternated video signal (Red) | |
| 23 | V _G | I | Alternated video signal (Green) | |
| 24 | V _B | I | Alternated video signal (Blue) | |
| 25 | AV _{DD} | P | Supply voltage for analog circuit | |
| 26 | AV _{SS} | P | Ground for analog circuit | |

I: input, O: output, P: Power

Note 1: Selection of scanning mode

| Setting of scan control input | | IN/OUT state for start pulse | | | | Scanning direction |
|-------------------------------|-----------------|------------------------------|------|------|------|---------------------------|
| U/D | L/R | STVD | STVU | STHR | STHL | |
| GND | V _{CC} | O | I | O | I | Up to down, left to right |
| V _{CC} | GND | I | O | I | O | Down to up, right to left |
| GND | GND | O | I | I | O | Up to down, right to left |
| V _{CC} | V _{CC} | I | O | O | I | Down to up, left to right |

Note 2: Definition of scanning direction.

Refer to the figure as below:

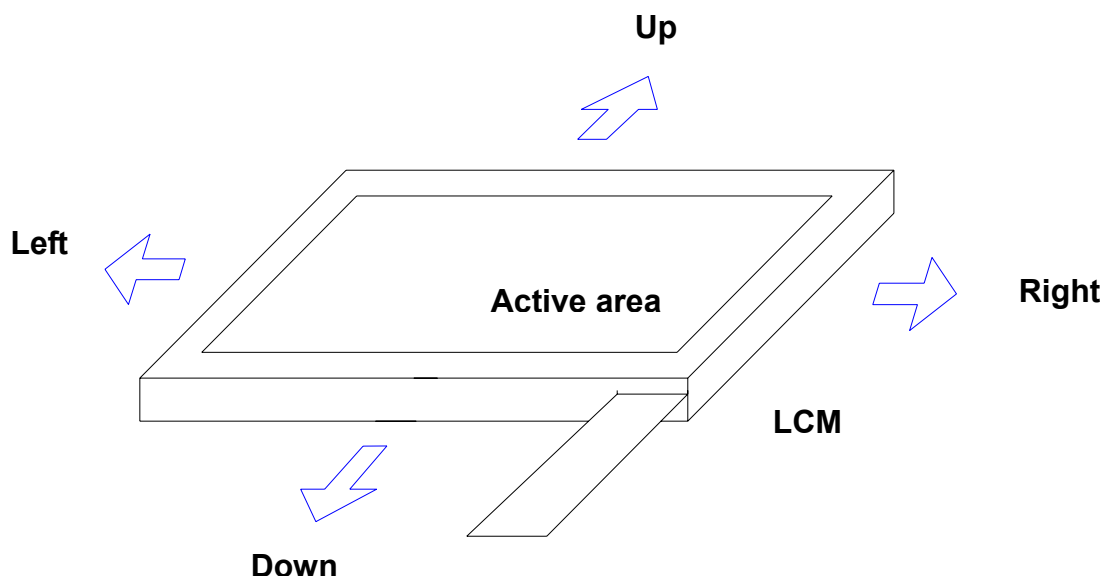

Note 3: MOD=H: Simultaneous sampling.

MOD=L: Sequential sampling.

Please set CPH2 and CPH3 to GND when MOD=H.

2.2. Backlight Unit Section

| Pin No. | Symbol | I/O | Function | Remark |
|---------|--------|-----|---------------------------------|--------|
| 1 | HI | P | Power supply for backlight unit | Pink |
| 2 | GND | P | Ground for backlight unit | White |

KTTIC

3. Operation Specifications

3.1. Absolute Maximum Rating

(GND=AV_{SS}=0V, Note 3)

| Item | Symbol | Values | | Unit | Remark |
|-----------------------|----------------------------------|--------|-----------------------|------|--------|
| | | Min. | Max. | | |
| Power voltage | V _{CC} | -0.3 | 7.0 | V | |
| | AV _{DD} | -0.3 | 7.0 | V | |
| | V _{GH} | -0.3 | 18.0 | V | |
| | V _{GL} | -15.0 | 0.3 | V | |
| | V _{GH} -V _{GL} | - | 33.0 | V | |
| Input signal voltage | V _i | -0.3 | AV _{DD} +0.3 | V | Note 1 |
| | V _f | -0.3 | V _{CC} +0.3 | V | Note 2 |
| Operation temperature | T _{OP} | -30 | 85 | °C | |
| Storage temperature | T _{ST} | -30 | 85 | °C | |

Note 1: V_R, V_G, V_B.

Note 2: STHL, STHR, OEH, L/R, CPH1~CPH3, STVD, STVU, OEV, CKV, U/D.

Note 3: The absolute maximum rating values of the module should not be exceeded. Once exceeded absolute maximum rating values, the characteristics of the module may not be recovered. Even in an extreme condition, may result in module permanently destroyed.

3.1.1. Typical Operation Conditions

(GND=AV_{SS}=0V, Note 4)

| Item | Symbol | Values | | | Unit | Remark |
|---|------------------|-----------------------|---------------------|-----------------------|------|--------------|
| | | Min. | Typ. | Max. | | |
| Power voltage | V _{CC} | 4.8 | 5.0 | 5.2 | V | Note 5 |
| | AV _{DD} | 4.8 | 5.0 | 5.2 | V | |
| | V _{GH} | 14.3 | 15.0 | 15.7 | V | |
| | V _{GL} | -10.5 | -10.0 | -9.5 | V | |
| Video signal amplitude (V _R , V _G , V _B) | V _{iA} | AV _{SS} +0.4 | - | AV _{DD} -0.4 | V | Note 1 |
| | V _{iAC} | - | 3.5 | - | V | AC component |
| | V _{iDC} | - | AV _{DD} /2 | - | V | DC component |
| V _{COM} | V _{CAC} | - | 5.4 | - | V | Note 2 |
| | V _{CDC} | - | 1.91 | - | V | DC component |
| Input logic high voltage | V _{IH} | 0.7V _{CC} | - | V _{CC} | V | Note 3 |
| Input logic low voltage | V _{IL} | 0 | - | 0.3V _{CC} | V | |

Note 1: Refer to Fig.3-3-(a).

Note 2: The brightness of LCD panel could be changed by adjusting the AC component of V_{COM}.

Note 3: STHL, STHR, OEH, L/R, CPH1~CPH3, STVD, STVU, OEV, CKV, U/D.

Note 4: GND, V_{CC}, and V_{GL} are applied to LCD first and then V_{GH} is applied.

Note 5: V_{CC} setting should match the signals output voltage(refer to Note 3) of customer's system board .

3.1.2. Current Consumption

(GND=AV_{SS}=0V)

| Item | Symbol | Values | | | Unit | Remark |
|--------------------|-----------------|--------|------|------|------|--------------------------|
| | | Min. | Typ. | Max. | | |
| Current for Driver | I _{GH} | - | 0.4 | 0.8 | mA | V _{GH} =15.0V |
| | I _{GL} | - | -0.5 | -1.0 | mA | V _{GL} = -10.0V |
| | I _{CC} | - | 5.0 | 8.0 | mA | V _{CC} =5.0V |
| | I _{DD} | - | 10.0 | 20.0 | mA | AV _{DD} =5.0V |

3.1.3. Backlight Driving Conditions

| Item | Symbol | Values | | | Unit | Remark |
|---------------|----------------|--------|------|------|------|--------|
| | | Min. | Typ. | Max. | | |
| LED voltage | V _L | - | 9.9 | 10.5 | V | Note 2 |
| LED current | I _L | - | 20 | - | mA | Note 2 |
| LED life time | - | 20,000 | - | - | Hr | Note 1 |

Note 1: The “LED life time” is defined as the module brightness decrease to 50% original brightness that the ambient temperature is 25°C and I_L =20mA.

Note 2: The LED driving condition is defined for each LED module.(3 LED Serial)

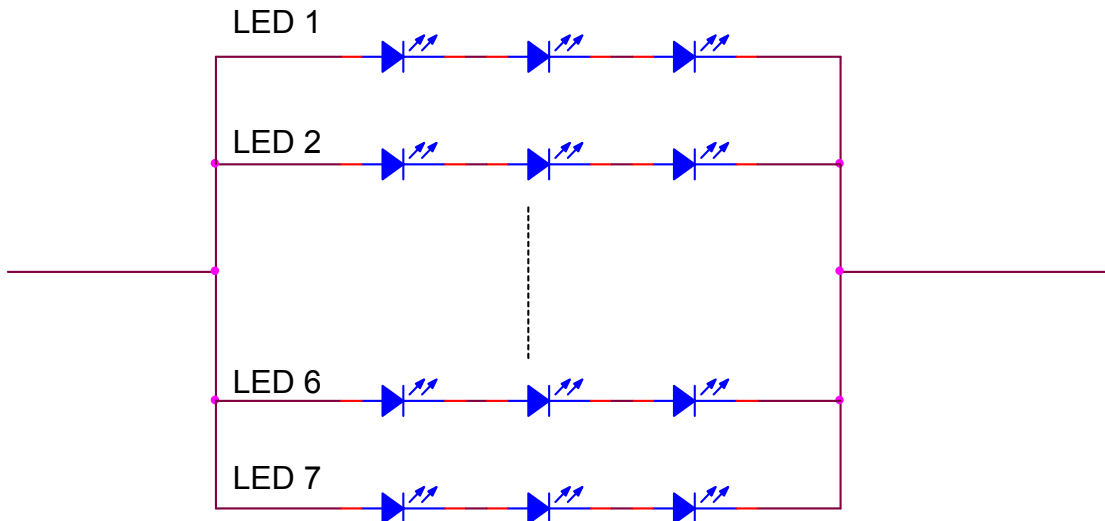

3.2. Power Sequence

3.2.1. Power on:

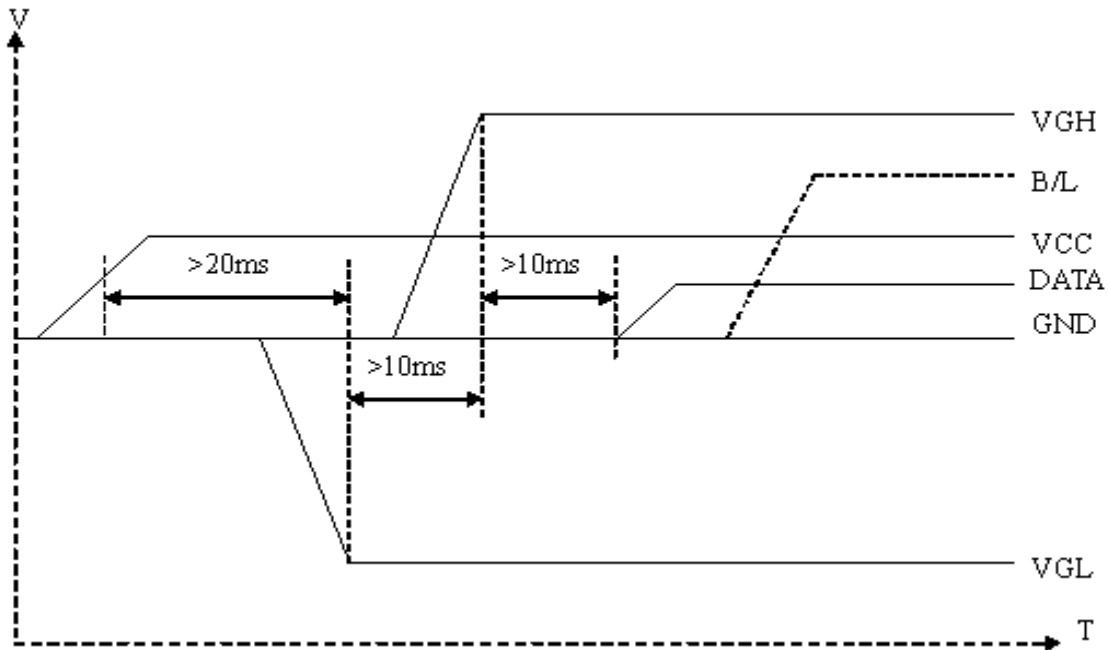

VCC → VGL → VGH → Data → B/L

3.2.2. Power off:

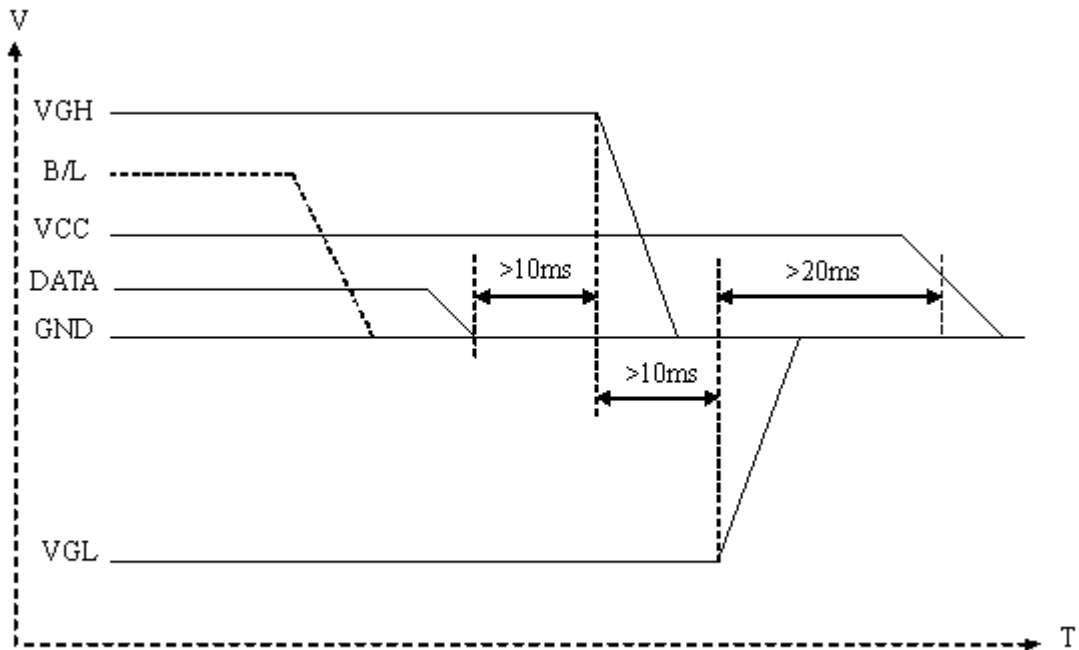

B/L → Data → VGH → VGL → VCC

3.3. Timing Characteristics

3.3.1. Timing Conditions

| Item | Symbol | Values | | | Unit | Remark |
|---------------------------------|------------|--------|-------------|-------------|-----------|------------|
| | | Min. | Typ. | Max. | | |
| Rising time | t_r | - | - | 60 | ns | Note 1 |
| Falling time | t_f | - | - | 60 | ns | Note 1 |
| High and low level pulse width | t_{CPH} | 150 | 154 | 158 | ns | CPH1~CPH3 |
| CPH pulse duty | t_{CWH} | 40 | 50 | 60 | % | CPH1~CPH3 |
| CPH pulse delay | t_{C12} | 30 | $t_{CPH}/3$ | $t_{CPH}/2$ | ns | CPH1~CPH3 |
| | t_{C23} | | | | | |
| | t_{C31} | | | | | |
| STH setup time | t_{SUH} | 20 | - | - | ns | STHR, STHL |
| STH hold time | t_{HDH} | 20 | - | - | ns | STHR, STHL |
| STH pulse width | t_{STH} | - | 1 | - | t_{CPH} | STHR, STHL |
| STH period | t_H | 61.5 | 63.5 | 65.5 | μs | STHR, STHL |
| OEH pulse width | t_{OEH} | - | 7 | - | μs | |
| Sample and hold disable time | t_{DIS1} | - | 55 | -- | μs | |
| OEV pulse width | t_{OEV} | - | 27 | | μs | |
| CKV pulse width | t_{CKV} | 16 | - | 40 | μs | |
| Clean enable time | t_{DIS2} | - | 16 | -- | μs | |
| Horizontal display timing range | t_{DH} | - | 960 | - | t_{CPH} | |
| STV setup time | t_{SUV} | 400 | - | - | ns | STVU, STVD |
| STV hold time | t_{HDV} | 400 | - | - | ns | STVU, STVD |
| STV pulse width | t_{STV} | - | - | 1 | t_H | STVU, STVD |

| | | | | | | |
|-------------------------------|------------|-----|-------|-----|---------|--------|
| Horizontal lines per field | t_v | 256 | 262.5 | 268 | t_H | Note 2 |
| Vertical display start | t_{SV} | - | 3 | - | t_H | |
| Vertical display timing range | t_{DV} | - | 234 | - | t_H | |
| VCOM rising time | t_{rCOM} | - | - | 5 | μs | |
| VCOM falling time | t_{fCOM} | - | - | 5 | μs | |
| VCOM delay time | t_{DCOM} | - | - | 3 | μs | |
| RGB delay time | t_{DRGB} | - | - | 1 | μs | |

Note 1: For all of the logic signals

Note 2: Please don't use odd horizontal lines to drive LCD panel for both odd and even field simultaneously.

KTTIC

3.3.2. Timing Diagram

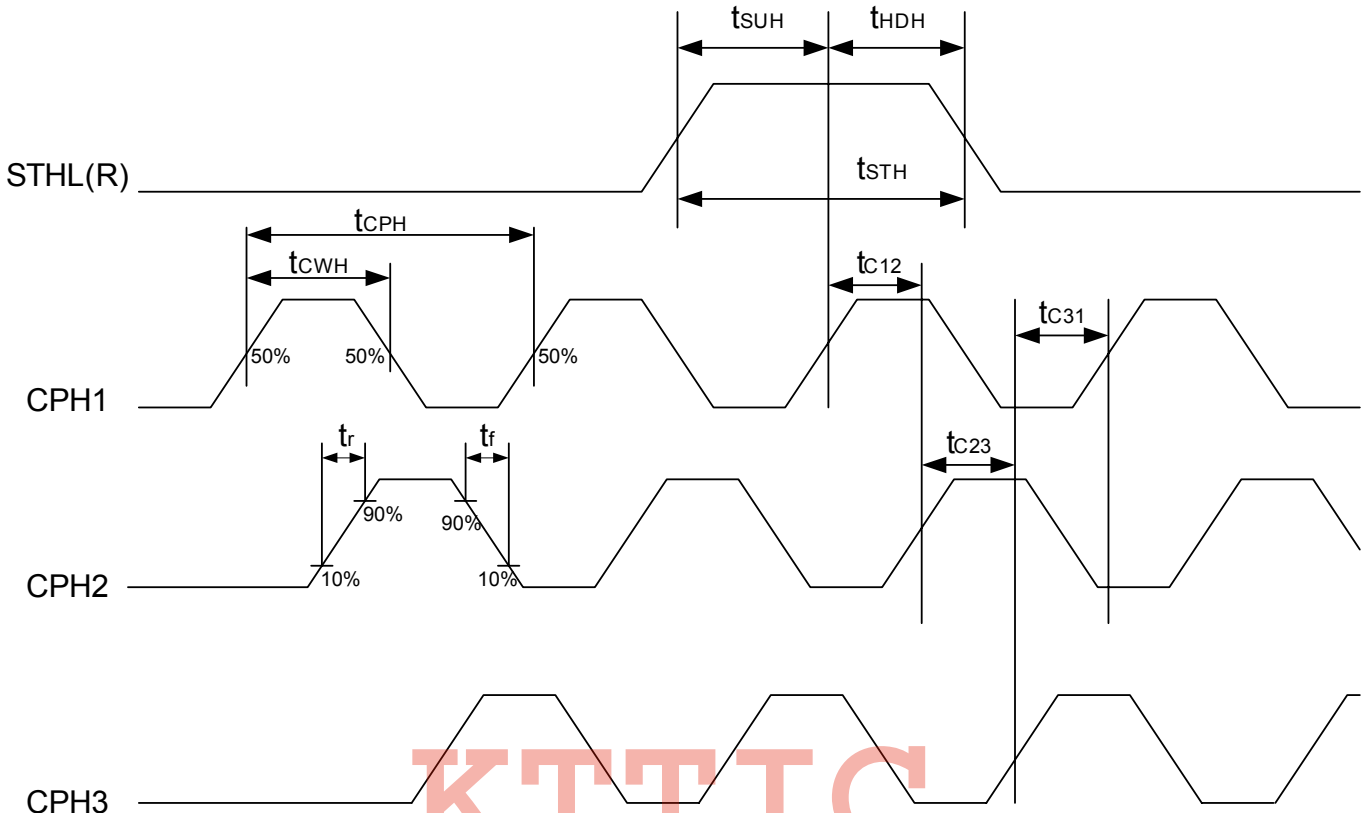

Fig.3-1 Sampling clock timing

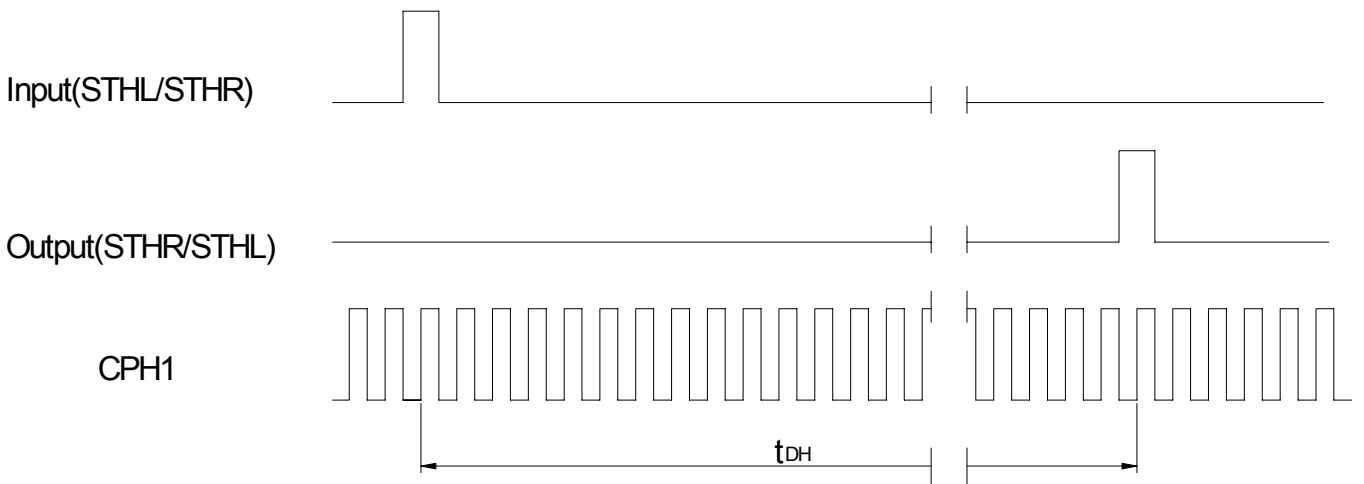

Fig.3-2 Horizontal display timing range

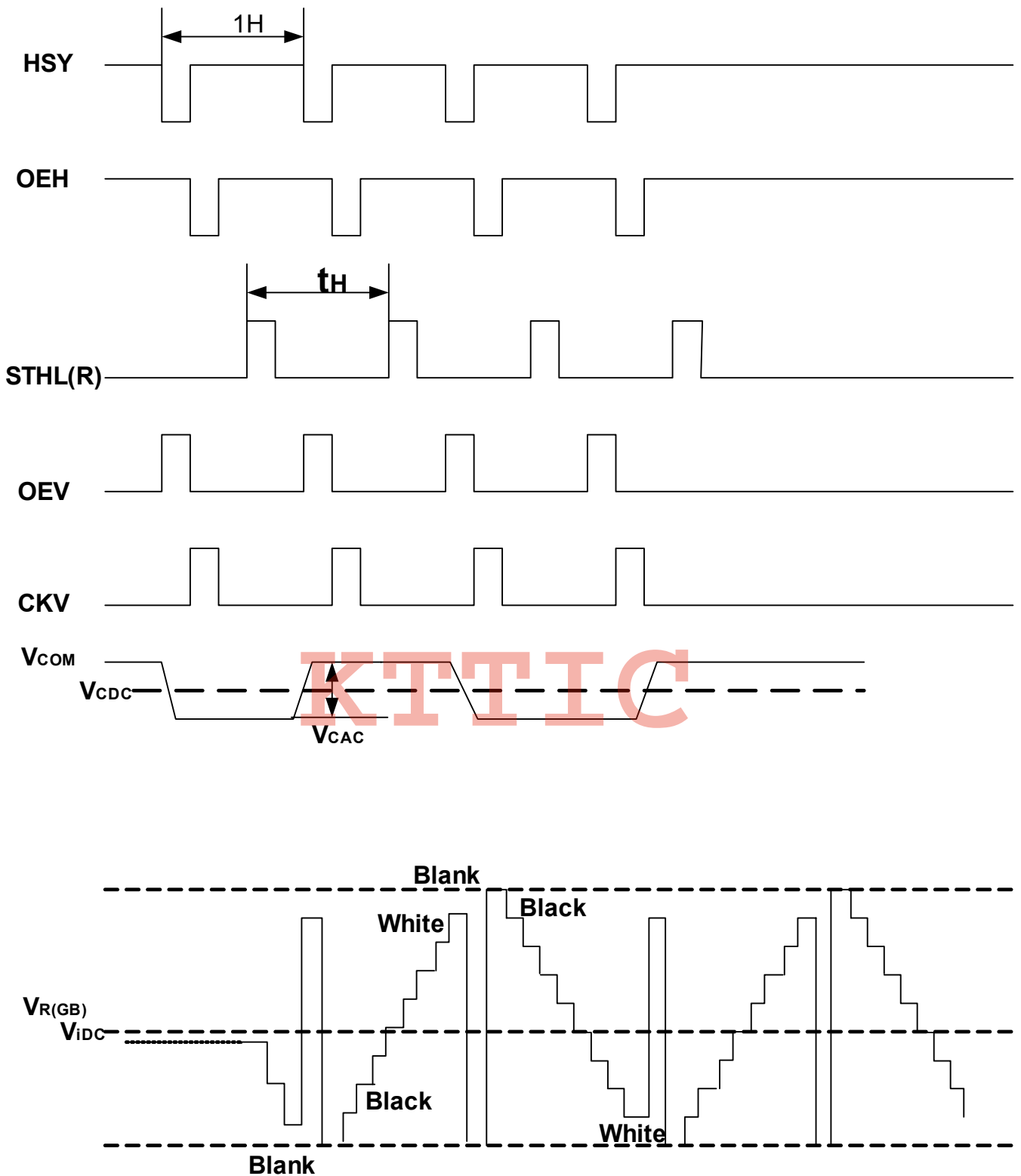

Fig.3-3-(a) Horizontal timing

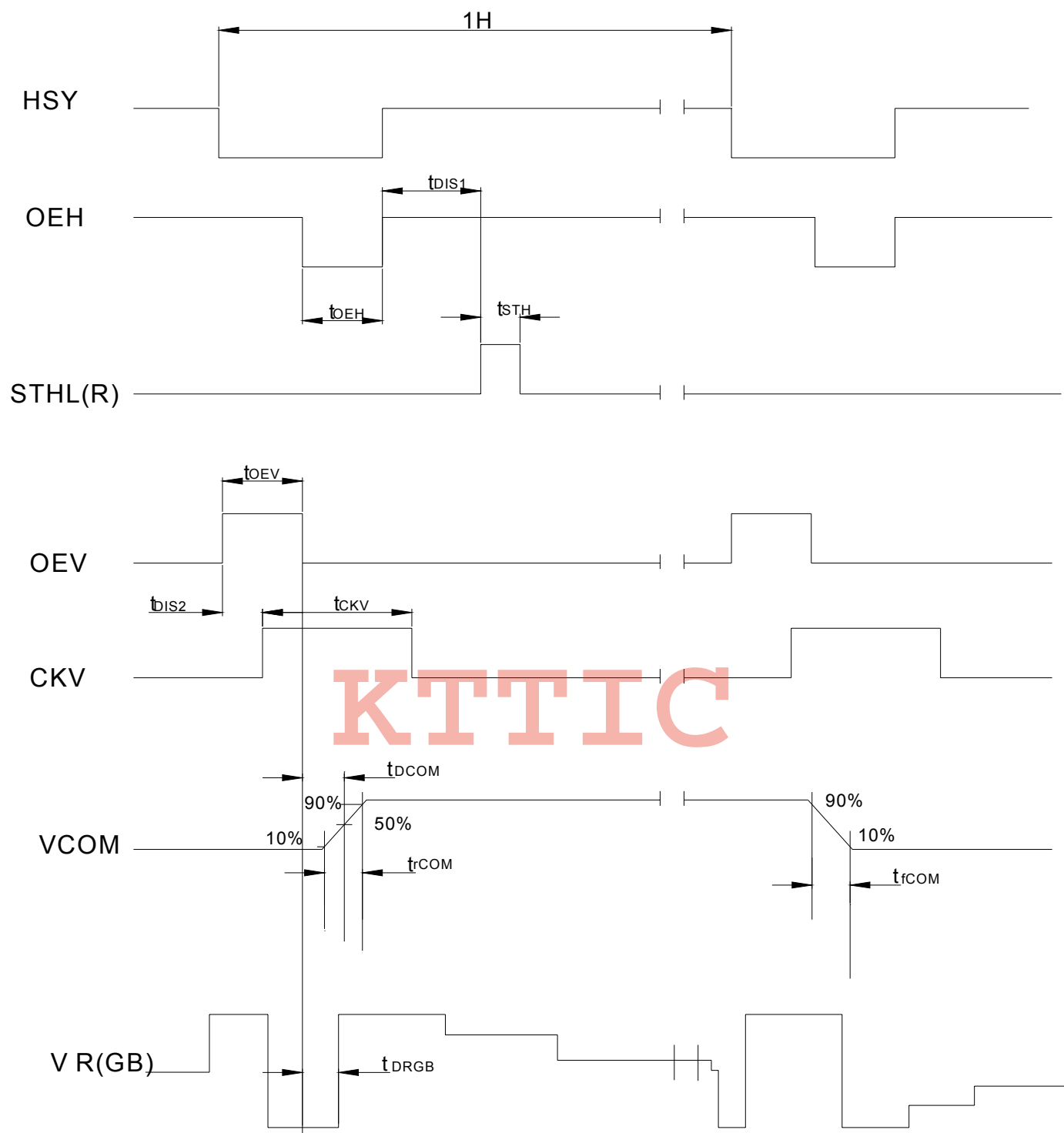

Fig.3-3-(b) Detail horizontal timing

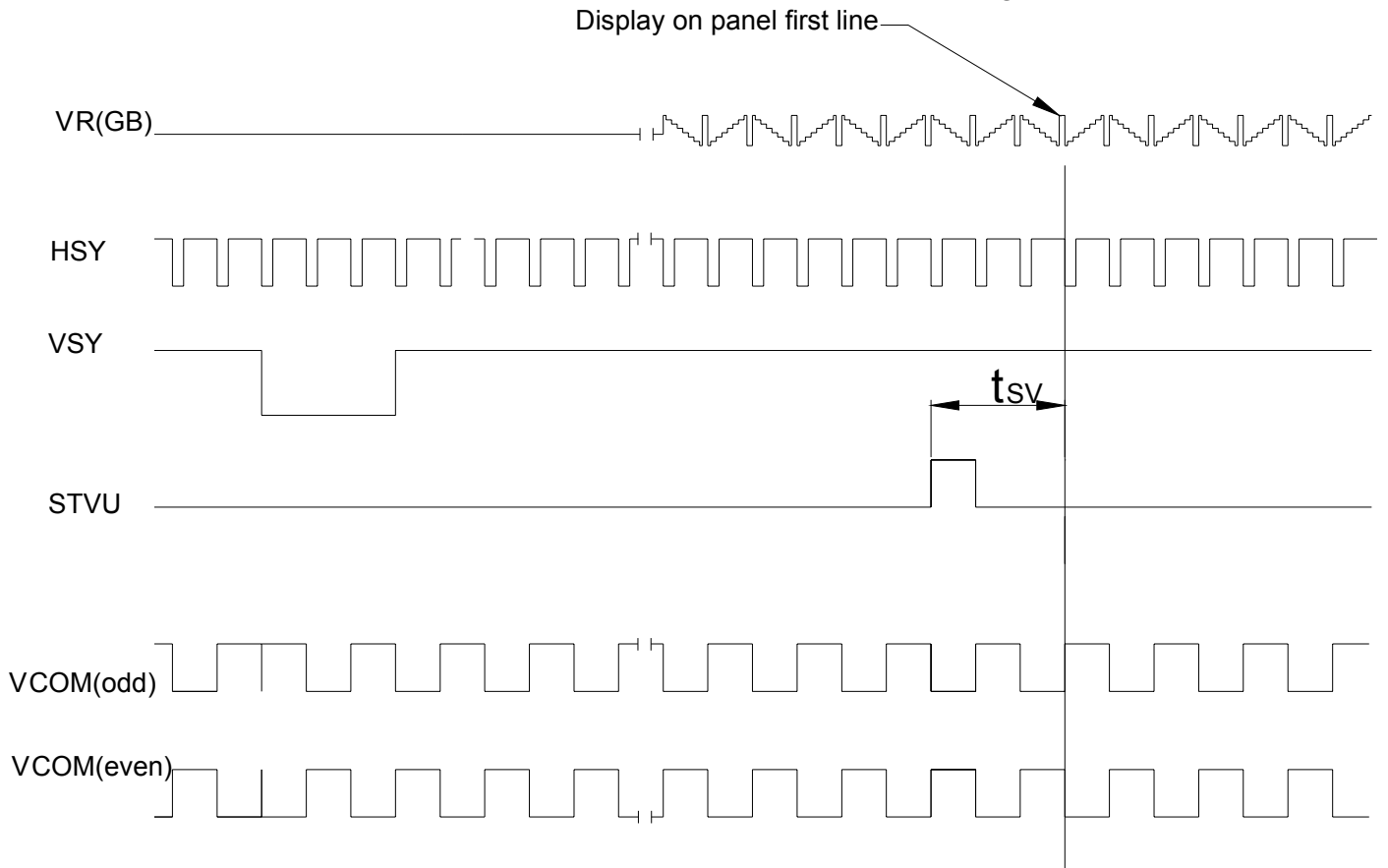

Fig.3-4(a) Vertical timing (from up to down)

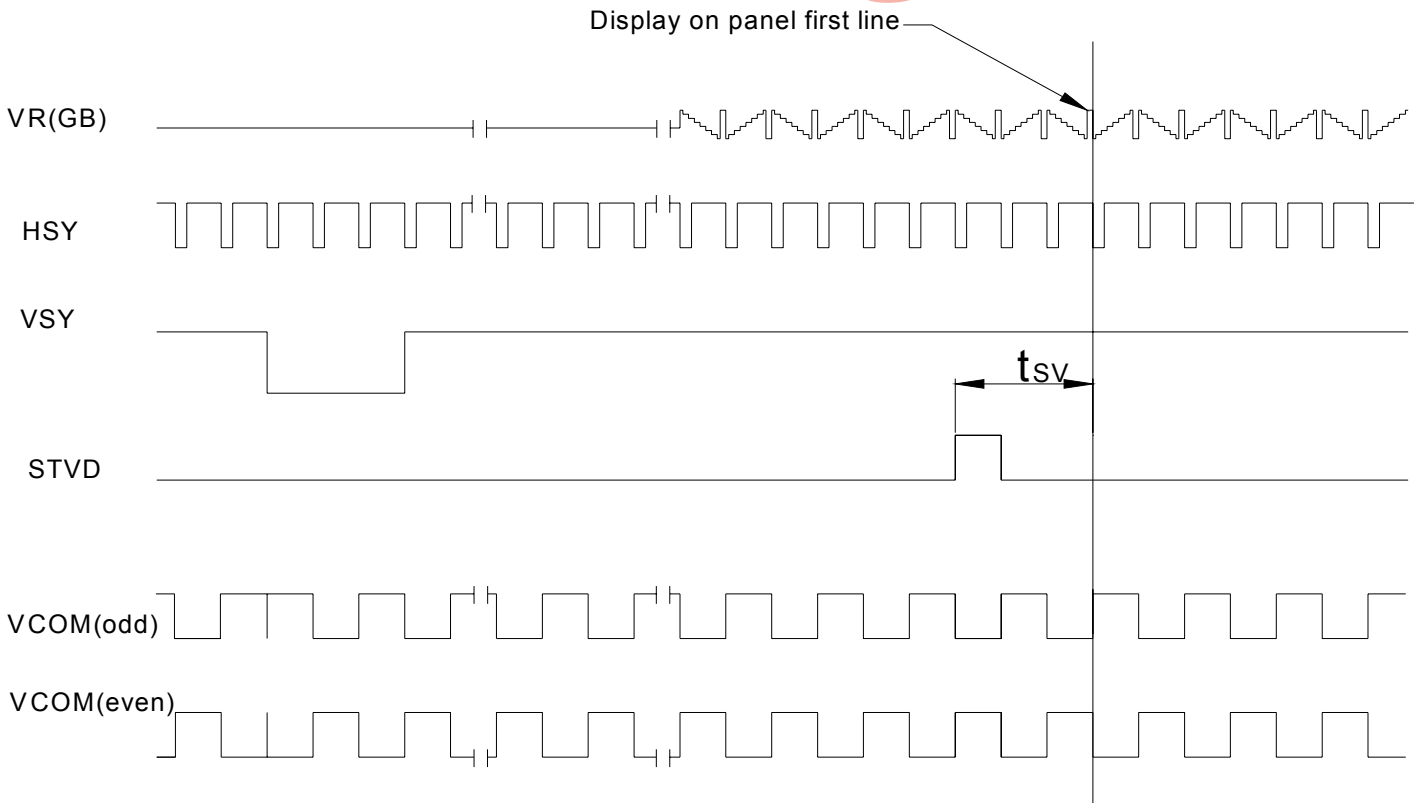

Fig.3-4(b) Vertical timing (from down to up)

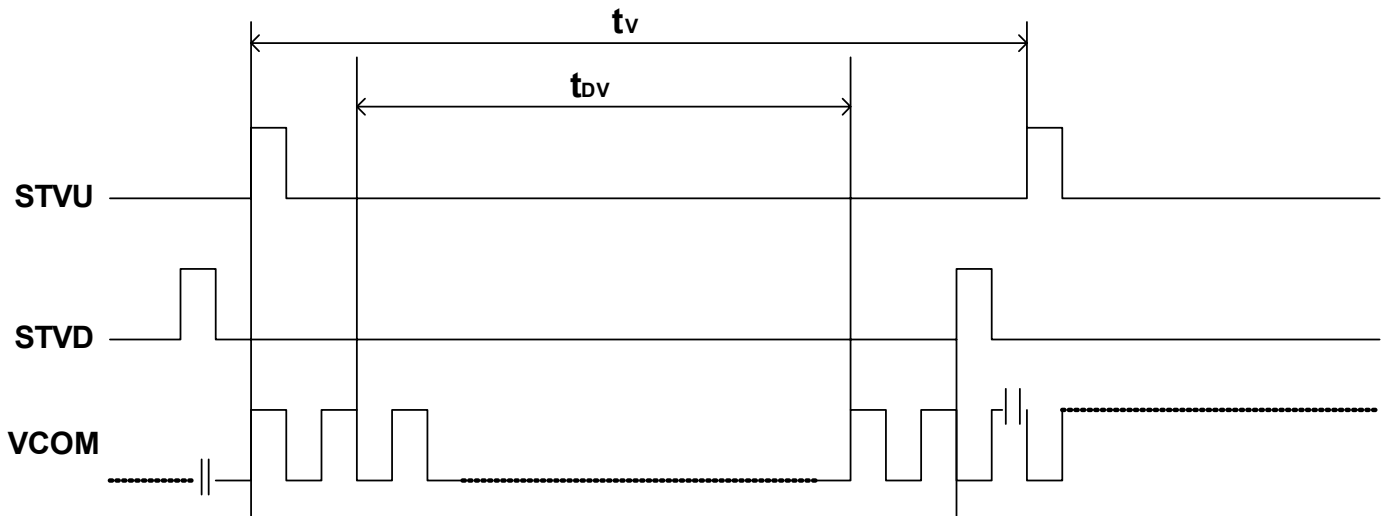

Fig.3-5 Vertical start pulse timing

KTTIC

4. Optical Specifications

| Item | Symbol | Condition | Values | | | Unit | Remark |
|--------------------------|------------|---------------------------------|--------|------|------|-------------------|------------------|
| | | | Min. | Typ. | Max. | | |
| Viewing angle (CR≥10) | θ_L | $\Phi=180^\circ$ (9 o'clock) | 55 | 65 | - | degree | Note 1 |
| | θ_R | $\Phi=0^\circ$ (3 o'clock) | 55 | 65 | - | | |
| | θ_T | $\Phi=90^\circ$ (12 o'clock) | 35 | 45 | - | | |
| | θ_B | $\Phi=270^\circ$ (6 o'clock) | 55 | 65 | - | | |
| Response time | T_{ON} | Normal $\theta=\Phi=0^\circ$ | - | 15 | 30 | msec | Note 3 |
| | T_{OFF} | | - | 20 | 40 | msec | Note 3 |
| Contrast ratio | CR | | 250 | 300 | - | - | Note 4 |
| Color chromaticity | W_X | | 0.25 | 0.30 | 0.35 | - | Note 2 Note 5 |
| | W_Y | | 0.28 | 0.33 | 0.38 | - | Note 6 |
| Luminance | L | | 200 | 250 | - | cd/m ² | Note 6 |
| Luminance uniformity | Y_U | | 70 | 75 | - | - | Note 7 |

Test Conditions:

1. $V_{CC}=5V$, $AV_{DD}=5V$, $I_L=20mA$ (Backlight current), the ambient temperature is $25^\circ C$.
2. The test systems refer to Note 2.

Note 1: Definition of viewing angle range

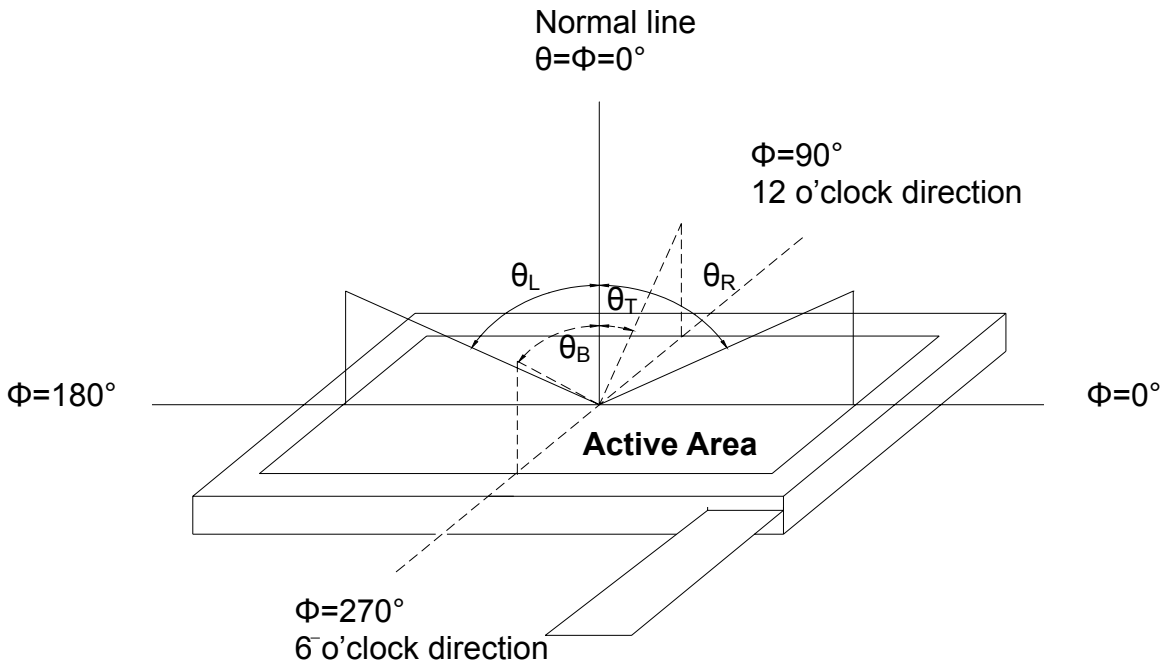

Fig. 4-1 Definition of viewing angle

Note 2: Definition of optical measurement system.

The optical characteristics should be measured in dark room. After 30 minutes operation, the optical properties are measured at the center point of the LCD screen. (Response time is measured by Photo detector TOPCON BM-7, other items are measured by BM-5A/Field of view: 1° /Height: 500mm.)

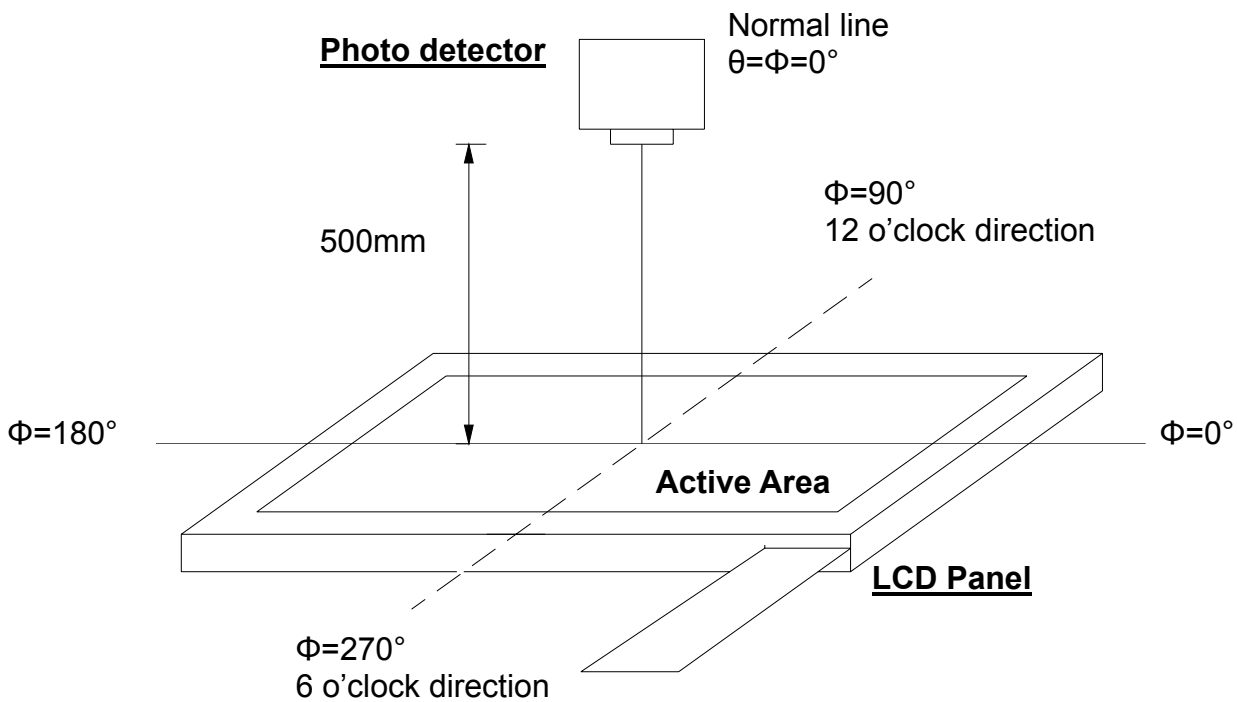

Fig. 4-2 Optical measurement system setup

The copyright belongs to InnoLux. Any unauthorized use is prohibited.

Note 3: Definition of Response time

The response time is defined as the LCD optical switching time interval between "White" state and "Black" state. Rise time (T_{ON}) is the time between photo detector output intensity changed from 90% to 10%. And fall time (T_{OFF}) is the time between photo detector output intensity changed from 10% to 90%.

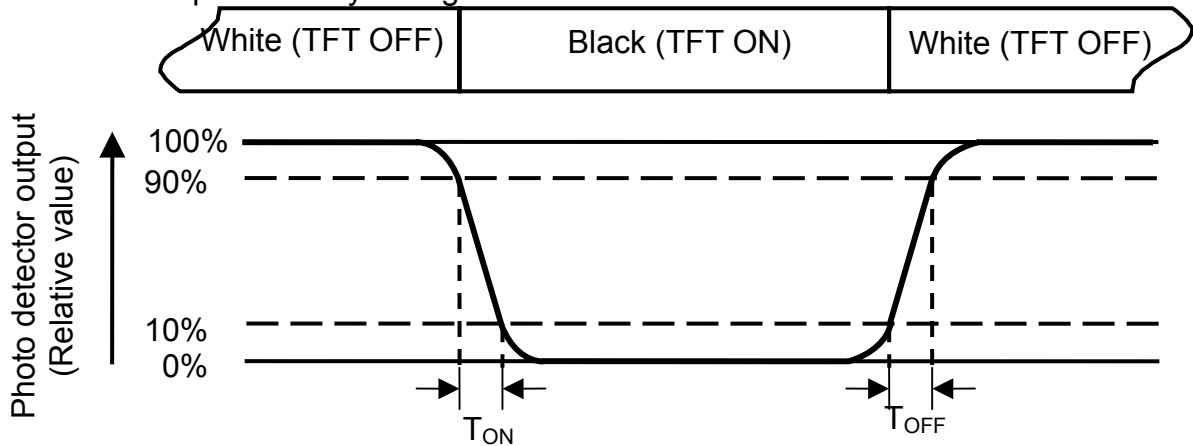

Fig. 4-3 Definition of response time

Note 4: Definition of contrast ratio

$$\text{Contrast ratio (CR)} = \frac{\text{Luminance measured when LCD is on the "White" state}}{\text{Luminance measured when LCD is on the "Black" state}}$$

White $V_i = V_{i50\%} \pm 1.5 \text{ V}$

Black $V_i = V_{i50\%} \mp 2.0 \text{ V}$

"±" means that the analog input signal swings in phase with V_{COM} signal.

"∓" means that the analog input signal swings out of phase with V_{COM} signal.

$V_{i50\%}$: The analog input voltage when transmission is 50%

The 100% transmission is defined as the transmission of LCD panel when all the input terminals of module are electrically opened.

Note 5: Definition of color chromaticity (CIE1931)

Color coordinates measured at center point of LCD.

Note 6: All input terminals LCD panel must be ground while measuring the center area of the panel.

Note 7: Definition of Luminance Uniformity

Active area is divided into 9 measuring areas (Refer to Fig. 4-4).Every measuring point is placed at the center of each measuring area.

$$\text{Luminance Uniformity (Yu)} = \frac{B_{min}}{B_{max}}$$

L-----Active area length W----- Active area width

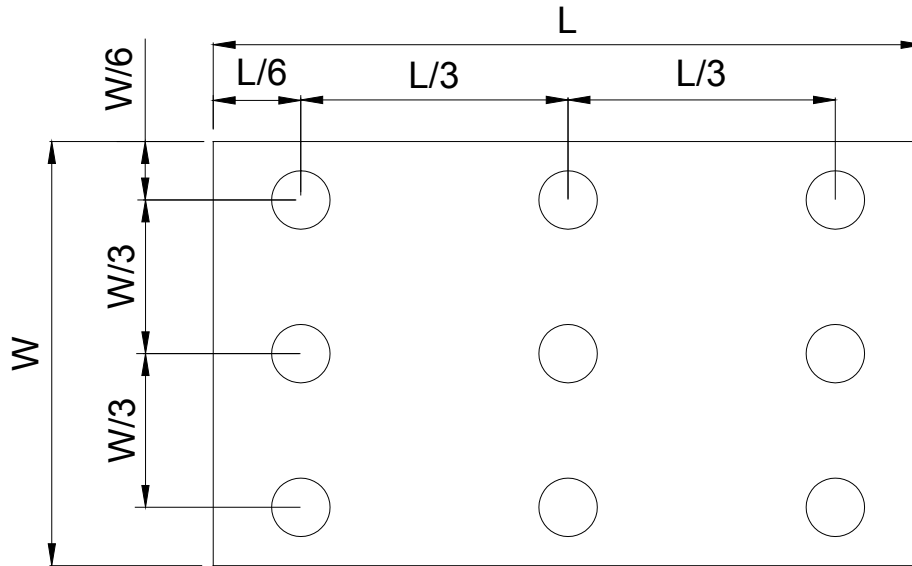

Fig. 4-4 Definition of measuring points

B_{max}: The measured maximum luminance of all measurement position.
B_{min}: The measured minimum luminance of all measurement position.

5. Reliability Test Items

(Note3)

| Item | Test Conditions | Remark |
|--|---|--------|
| High Temperature Storage | Ta = 85°C 240 hrs | Note 1 |
| Low Temperature Storage | Ta = -30°C 240hrs | Note 1 |
| High Temperature Operation | Ts = 85°C 240hrs | Note 2 |
| Low Temperature Operation | Ta = -30°C 240hrs | Note 1 |
| Operate at High Temperature and Humidity | +60°C, 90%RH 240 hrs | |
| Thermal Shock | -30°C/30 min ~ +85°C/30 min for a total 100 cycles, Start with cold temperature and end with high temperature | |
| Vibration Test | Frequency range:10~55Hz Stroke:1.5mm Sweep:10Hz~55Hz~10Hz 2 hours for each direction of X. Y. Z. (6 hours for total) | |
| Mechanical Shock | 100G 6ms,±X, ±Y, ±Z 3 times for each direction | |
| Package Vibration Test | Random Vibration : 0.015G*G/Hz from 5-200HZ, -6dB/Octave from 200-500HZ 2 hours for each direction of X. Y. Z. (6 hours for total) | |
| Package Drop Test | Height:60 cm 1 corner, 3 edges, 6 surfaces | |
| Electro Static Discharge | ± 2KV, Human Body Mode, 100pF/1500Ω | |

Note 1: Ta is the ambient temperature of samples.

Note 2: Ts is the temperature of panel's surface.

Note 3: In the standard condition, there shall be no practical problem that may affect the display function.

6. General Precautions

6.1. Safety

Liquid crystal is poisonous. Do not put it in your mouth. If liquid crystal touches your skin or clothes, wash it off immediately by using soap and water.

6.2. Handling

1. The LCD panel is plate glass. Do not subject the panel to mechanical shock or to excessive force on its surface.
2. The polarizer attached to the display is easily damaged. Please handle it carefully to avoid scratch or other damages.
3. To avoid contamination on the display surface, do not touch the module surface with bare hands.
4. Keep a space so that the LCD panels do not touch other components.
5. Put cover board such as acrylic board on the surface of LCD panel to protect panel from damages.
6. Transparent electrodes may be disconnected if you use the LCD panel under environmental conditions where the condensation of dew occurs.
7. Do not leave module in direct sunlight to avoid malfunction of the ICs.

6.3. Static Electricity

1. Be sure to ground module before turning on power or operating module.
2. Do not apply voltage which exceeds the absolute maximum rating value.

6.4. Storage

1. Store the module in a dark room where must keep at $+25\pm 10^{\circ}\text{C}$ and 65%RH or less.
2. Do not store the module in surroundings containing organic solvent or corrosive gas.
3. Store the module in an anti-electrostatic container or bag.

6.5. Cleaning

1. Do not wipe the polarizer with dry cloth. It might cause scratch.
2. Only use a soft cloth with IPA to wipe the polarizer, other chemicals might permanent damage to the polarizer.

7. Mechanical Drawing

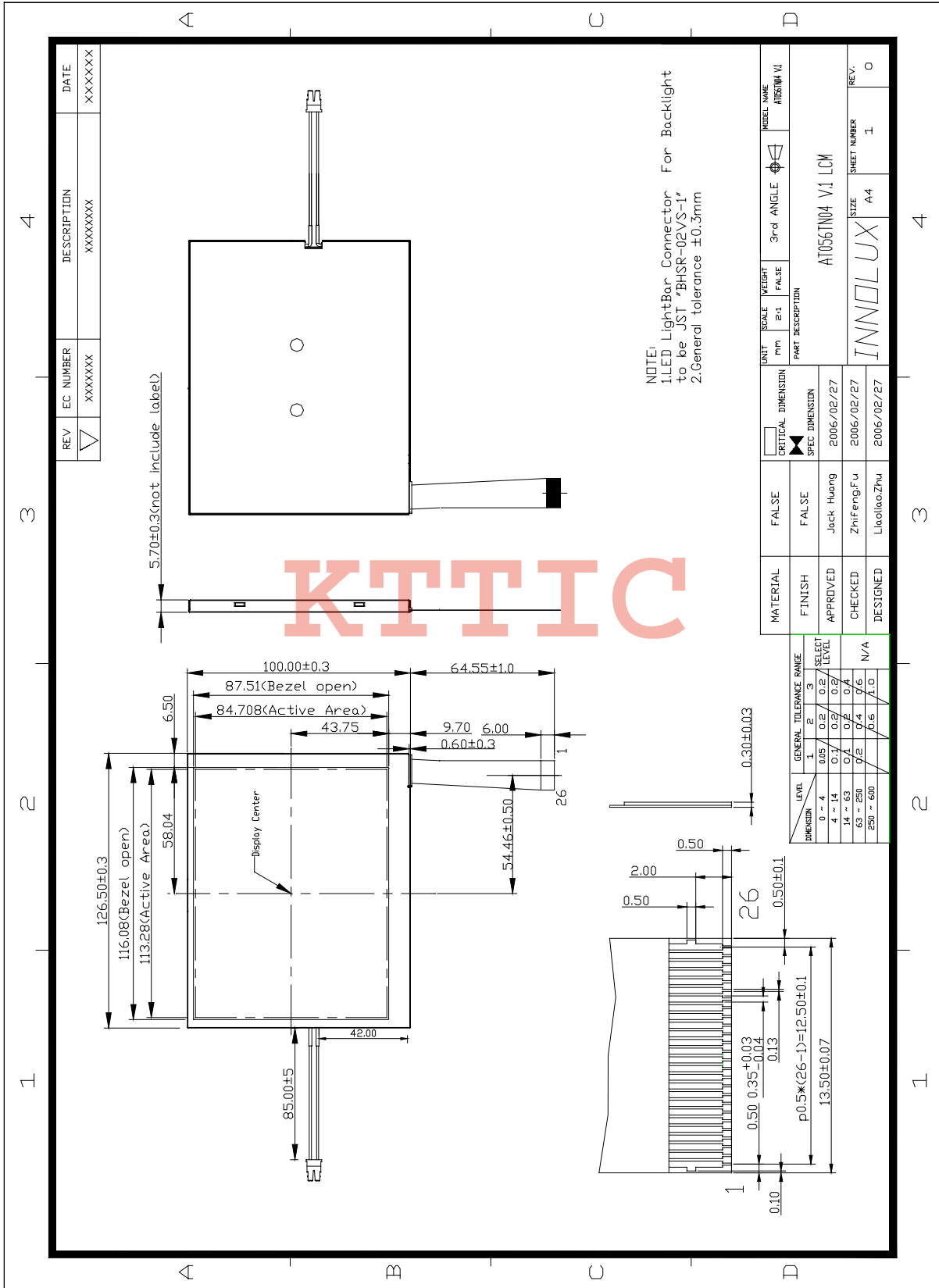

8. Package Drawing

8.1. Packaging Material Table

| No. | Item | Model (Material) | Dimensions(mm) | Unit Weight (kg) | Quantity | Remark | |
|-----|------------------|---------------------|----------------|------------------|----------|--------|--|
| 1 | LCM Module | AT056TN04 V.1 | 126.5×100×5.7 | 0.129 | 68pcs | | |
| 2 | Partition | B Corrugated paper | 105×349 | 0.020 | 2pcs | | |
| 3 | Corrugated Board | B Corrugated paper | 510×350 | 0.144 | 2pcs | | |
| 4 | Partition Paper | BC Corrugated paper | 512×226×349 | 1.170 | 1set | | |
| 5 | Dust-Proof Bag | PE | 700×530 | 0.0604 | 1pcs | | |
| 6 | A/S Bag | PE | 170×110×0.2 | 0.0018 | 68pcs | | |
| 7 | Carton | Corrugated paper | 530x355x255 | 1.100 | 1pcs | | |
| 8 | Total Weight | 11.55 kg | | | | | |

8.2. Packaging Quantity

| |
|---|
| Total LCM quantity in Carton: no. of Partition 4 Rows x quantity per Row 17= 68 |
|---|

8.3. Packaging Drawing

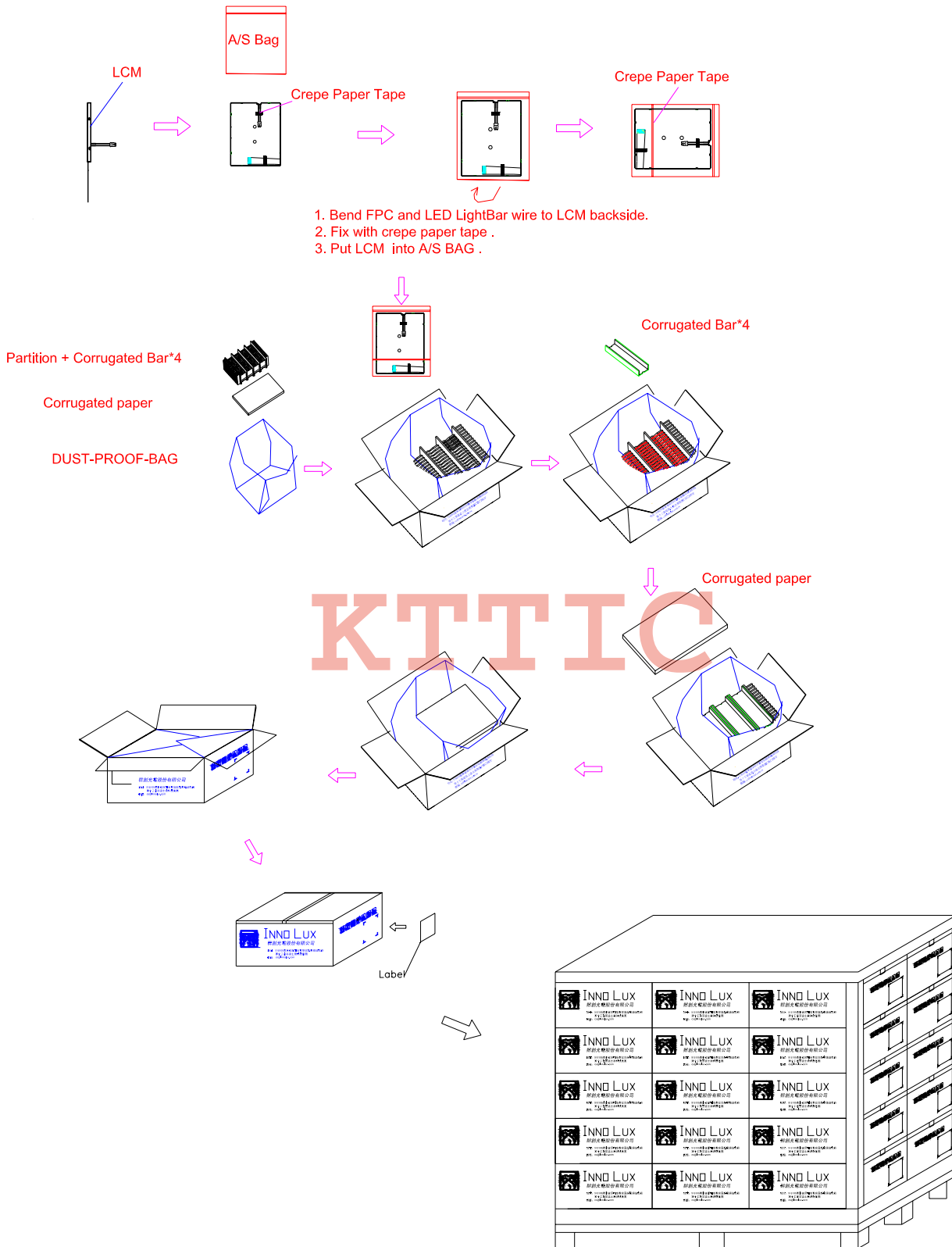

KTTIC <http://www.kttic.com>

KTTIC

<http://www.kttic.com>