

**INNOLUX DISPLAY CORPORATION**  
LCD MODULE  
**SPECIFICATION**

Customer: \_\_\_\_\_

Model Name: AT025TN12

SPEC NO.: A025-12-TT-01

Date: 2007/08/06

Version: 01

Preliminary Specification

Final Specification

For Customer's Acceptance

Approved by	Comment

Approved by	Reviewed by	Prepared by

### Record of Revision

Version	Revise Date	Page	Content
Pre SPEC 01	2007/04/04		Initial release.
Final SPEC 01	2007/08/24	1	Add the backlight & panel power consumption and the weight of LCM
		5	Add the power voltage
		6	Add the current for driver
		7	Update the power sequence
		17	Add the register value
		22	Update the mechanical drawing
		23	Update the package drawing

Contents:

1. General Specifications.....	1
2. Pin Assignment.....	2
2.1. TFT LCD Panel Driving Section .....	2
3. Operation Specifications.....	4
3.1. Absolute Maximum Rating .....	4
3.2. Electrical Characteristics .....	5
3.2.1. Typical Operation Conditions .....	5
3.2.2. Current Consumption .....	6
3.2.3. Backlight Driving Condition .....	6
3.3. Power Sequence .....	7
3.4. Timing Characteristics .....	10
3.4.5 SPI Timing Diagram .....	16
4. Optical Specifications .....	18
5. Reliability Test Items .....	22
6. Handling Precautions .....	23
6.1. Safety .....	23
6.2. Handling .....	23
6.3. Static Electricity .....	23
6.4. Storage .....	23
6.5. Cleaning .....	23
7. Mechanical Drawing .....	24
8. Package Drawing .....	25
8.1 Packaging Material Table .....	25
8.2 Packaging Quantity .....	25

## 1. General Specifications

No.	Item	Specification	Remark
1	LCD size	2.5" inch	
2	Driver element	a-Si TFT active matrix	
3	Resolution	320XRGBX240	
4	Display mode	Normally White, Transmissive	
5	Dot pitch	0.052(W)X0.156(H) mm	
6	Active area	49.92(W)X37.44(L) mm	
7	Module size	56.4(W)X49.12(L)X2.7(T) mm	
8	Surface treatment	Anti-Glare	Note 1
9	Color arrangement	RGB-stripe	
10	Interface	Digital	
11	Backlight power consumption	0.198W(Typ.)	
12	Panel power consumption	39.6mW(Typ.)	
13	Weight	16.84g	

Note 1: Refer to Mechanical Drawing.

## 2. Pin Assignment

### 2.1. TFT LCD Panel Driving Section

FPC Connector is used for the module electronics interface. The recommended model is FH26-45S-0.3SHW manufactured by Hirose.

Pin No.	Symbol	I/O(Note1)	Function	Remark
1	LED-A	P	Anode for LEDs	
2	LED-C	P	Cathode for LEDs	
3	VCOMH	C	Power setting capacitor for VCOM	
4	VCOML	C	Power setting capacitor for VCOM	
5	C21+	C	Step-Up capacitor	
6	C21-	C	Step-Up capacitor	
7	C22+	C	Step-Up capacitor	
8	C22-	C	Step-Up capacitor	
9	C23+	C	Step-Up capacitor	
10	C23-	C	Step-Up capacitor	
11	VGL	C	Power setting capacitor	
12	VGH	C	Power setting capacitor	
13	VCL	C	Power setting capacitor	
14	C13+	C	Step-Up capacitor	
15	C13-	C	Step-Up capacitor	
16	DDVDH	C	Power setting capacitor	
17	C11-	C	Step-Up capacitor	
18	C11+	C	Step-Up capacitor	
19	C12-	C	Step-Up capacitor	
20	C12+	C	Step-Up capacitor	

21	VCI1	C	Power setting capacitor	
22	AV <sub>DD</sub>	P	Analog Power supply	
23	VREG1OUT	C	Power setting capacitor	
24	VCORE	C	Power setting capacitor	
25	AGND	P	Analog Power for Circuit	
26	DV <sub>DD</sub>	P	Digital Power supply	
27	RESET	I	Reset Signal	
28	IF2	I	System interface selection pin	Note2
29	IF1	I	System interface selection pin	
30	SCL	I	SPI clock signal	
31	CS	I	SPI chip select signal	
32	SDA	I	SPI interface input pin	
33	DATA7	I	DATA7	
34	DATA6	I	DATA6	
35	DATA5	I	DATA5	
36	DATA4	I	DATA4	
37	DATA3	I	DATA3	
38	DATA2	I	DATA2	
49	DATA1	I	DATA1	
40	DATA0	I	DATA0	
41	DGND	P	Digital Ground for Circuit	
42	DCLK	I	DCLK	
43	HSYNC	I	Horizontal Synchronizing input signal	
44	VSYNC	I	Vertical Synchronizing input signal	
45	DE	I	Input Data enable signal	

Note1: P – Power

I - Input

C –Capacitor

Note2: IF2=1, IF1=1.Select ITU-RBT.656 Mode

IF2=1, IF1=0.Select ITU-RBT.601 Mode

IF2=0, IF1=0.Select 8bit serial RGB Mode

### 3. Operation Specifications

#### 3.1. Absolute Maximum Rating

(GND =0V, Note 1)

Item	Symbol	Values		Unit	Remark
		Min.	Max.		
Power voltage	DV <sub>DD</sub>	2.7	3.6	V	
	AV <sub>DD</sub>	2.7	3.6	V	
Operation Temperature	T <sub>OP</sub>	-20	70	°C	
Storage Temperature	T <sub>ST</sub>	-30	80	°C	
LED Reverse Voltage	V <sub>r</sub>	-	1.2	V	Each LED Note 2
LED Forward Current	I <sub>F</sub>	-	25	mA	Each LED

Note 1: The absolute maximum rating values of this product are not allowed to be exceeded at any times. Should a module be used with any of the absolute maximum ratings exceeded, the characteristics of the module may not be recovered, or in an extreme case, the module may be permanently destroyed.

Note 2: Vr Conditions: Zener Diode 20mA



## 3.2. Electrical Characteristics

### 3.2.1. Typical Operation Conditions

(GND =0V, Note 1)

Item	Symbol	Values			Unit	Remark
		Min.	Typ.	Max.		
Power voltage	DV <sub>DD</sub>	3.13	3.3	3.46	V	
	AV <sub>DD</sub>	3.13	3.3	3.46	V	
Input logic high voltage	V <sub>IH</sub>	0.7 x DV <sub>DD</sub>	-	DV <sub>DD</sub>	V	
Input logic low voltage	V <sub>IL</sub>	0	-	0.3 x DV <sub>DD</sub>	V	

Note 1: Be sure to apply GND, DV<sub>DD</sub>, AV<sub>DD</sub> and V<sub>GL</sub> to the LCD first, and then apply V<sub>GH</sub>.

KTTIC



3.2.2. Current Consumption

(GND =0V)

Item	Symbol	Values			Unit	Remark
		Min.	Typ.	Max.		
Current for Driver	I <sub>AVDD</sub>	-	2	2.4	mA	AVDD=3.3V
	I <sub>DVDD</sub>	-	10	12	mA	DVDD=3.3V

3.2.3. Backlight Driving Condition

Item	Symbol	Values			Unit	Remark
		Min.	Typ.	Max.		
LED forward voltage	V <sub>L</sub>	9.3	9.9	10.5	V	Note2, 3
LED forward current	I <sub>L</sub>	18	20	22	mA	Note 3
LED life time	-	20,000	-	-	Hr	Note 1

Note 1: The “LED life time” is defined as the module brightness decrease to 50% original brightness at Ta=25°C and I<sub>L</sub> =20mA. The LED lifetime could be decreased if operating I<sub>L</sub> is larger than 20 mA.

Note 2: The LED Supply Voltage is defined by the number of LED at Ta=25°C and I<sub>L</sub> =20mA. In the case of 3pcs LED, V<sub>L</sub>=3.3 x 3=9.9V

Note 3: The LED driving condition is defined for each LED module (3 LED Serial).

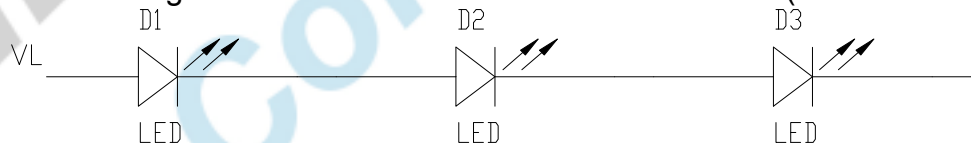

### 3.3. Power Sequence

#### 3.3.1 Power ON Sequence

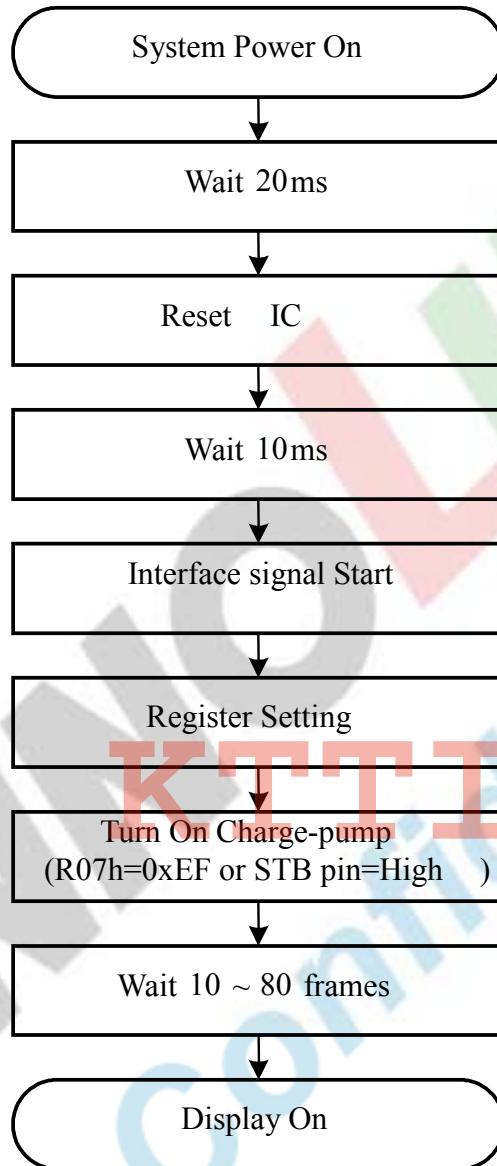

Power On Sequence Flow Chart

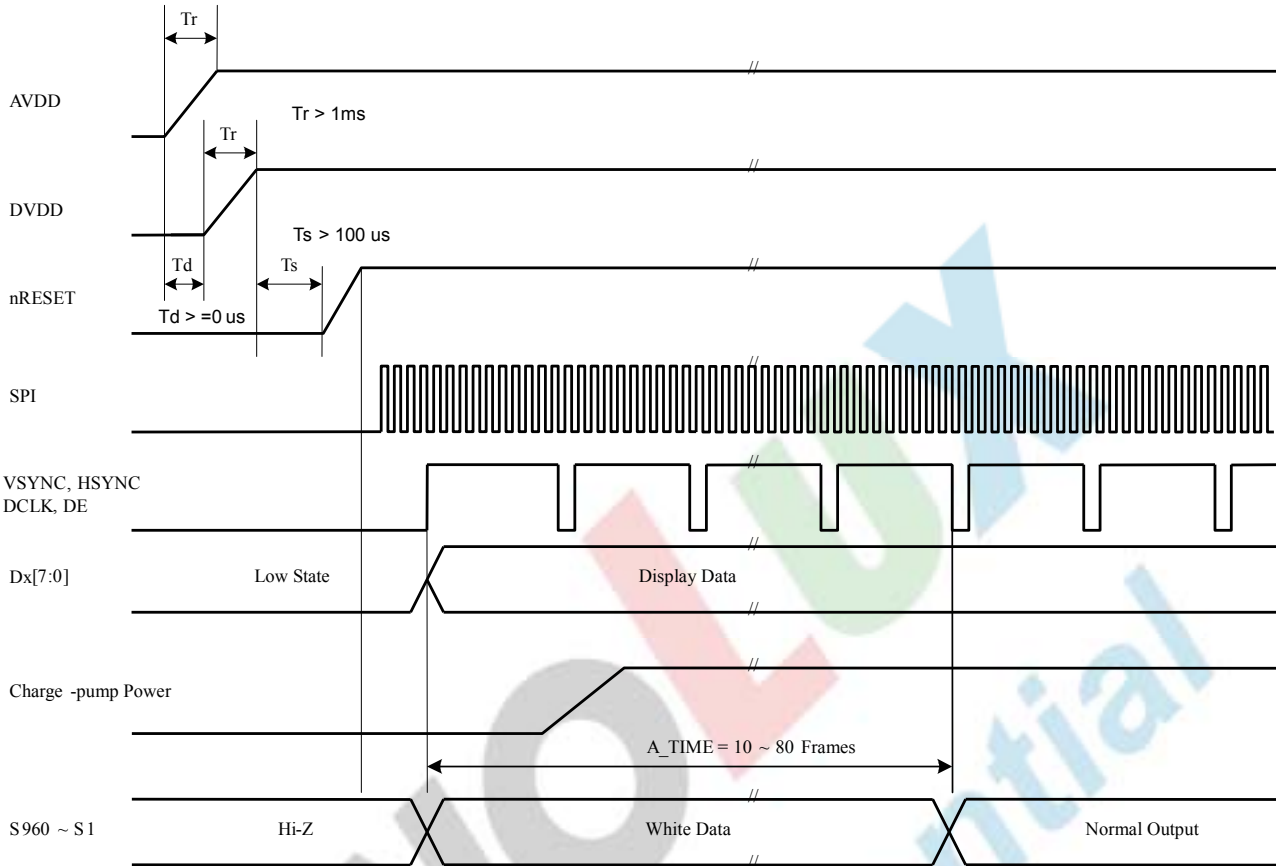

### 3.3.2 Power OFF Sequence

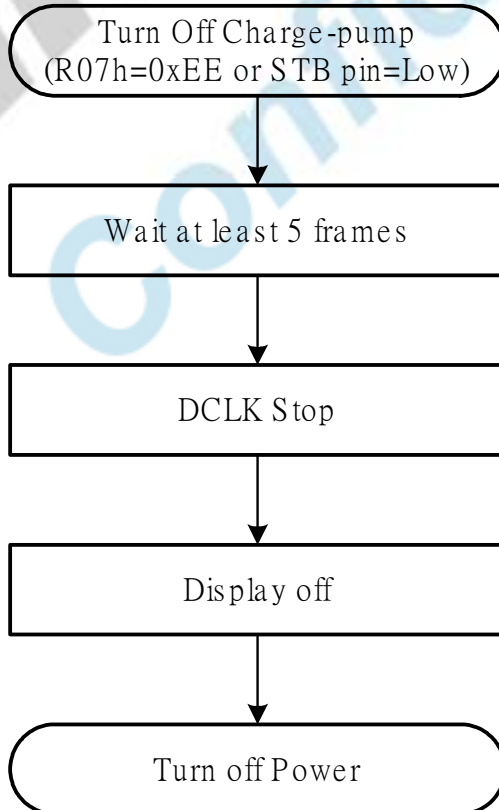

Power Off Sequence Flow Chart

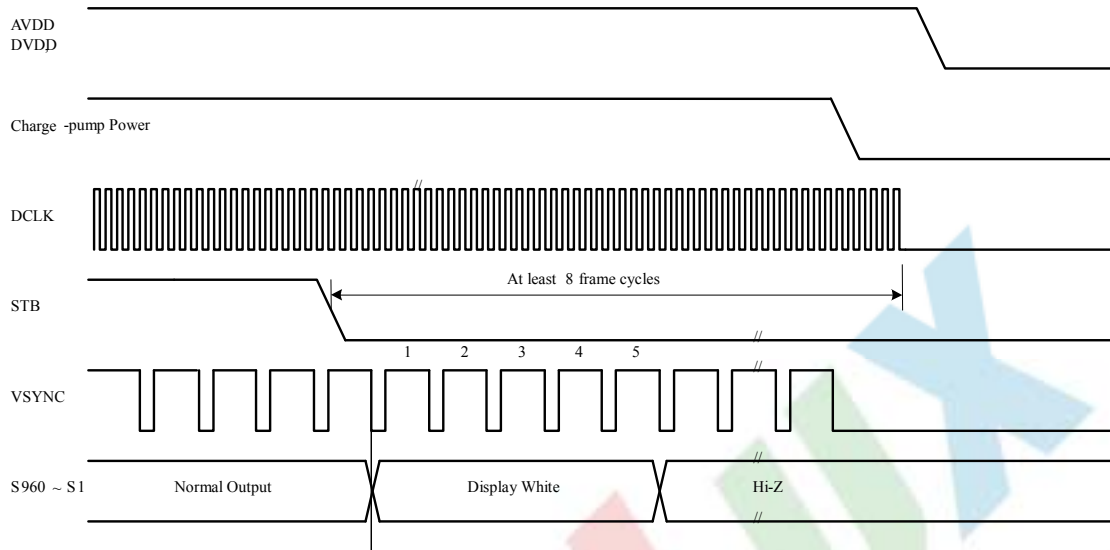

Note : Data include S960~S1

KTTIC

### 3.4. Timing Characteristics

#### 3.4.1 ITU-BT.601 Interface

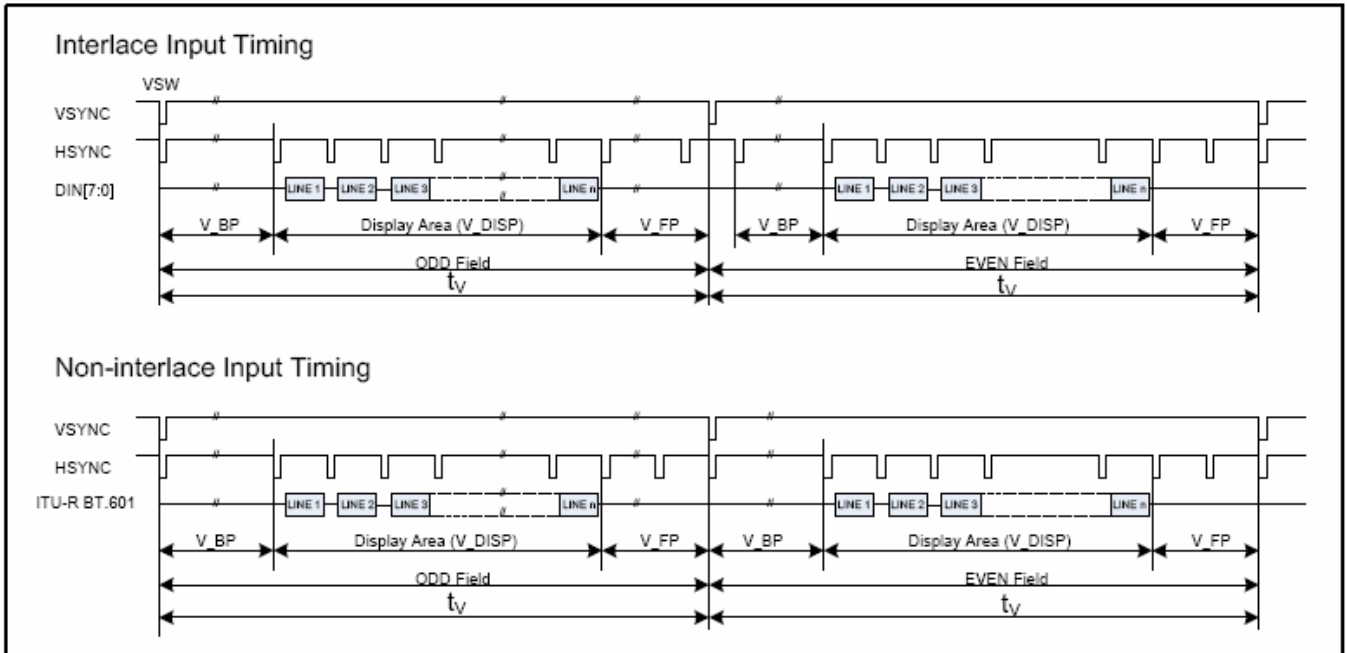

Figure1 ITR-R BT.601 Vertical Input Signal

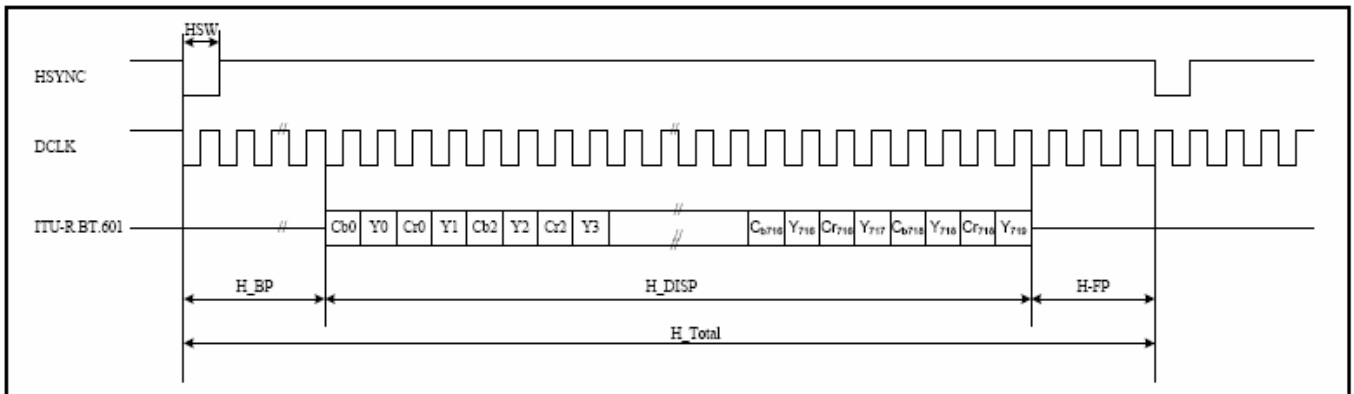

Figure2 ITR-R BT.601 Horizontal Input Signal

版權屬於群創所有，禁止任何未經授權的使用

ITU-R BT.601 27 MHz (360 Mode) timing specifications:

Parameter		Symbol	360Mode	320Mode	Unit.	Remark
DCLK Frequency		1/t <sub>DCLK</sub>	27	24.54	MHz	
HSYNC	Period	t <sub>H</sub>	1716	1560	t <sub>DCLK</sub>	
	Display	H_DISP	1440	1280	t <sub>DCLK</sub>	
	Back Porch	H_BP	252	252	t <sub>DCLK</sub>	Note 1
	Front Porch	H_FP	-	-	t <sub>DCLK</sub>	
	Pulse Width	HSW	1	1	t <sub>DCLK</sub>	
VSYNC	Period	t <sub>V</sub>	262.5(312.5)	262.5(312.5)	t <sub>H</sub>	
	Valid Display period	V_DISP	240(288)	240(288)	t <sub>H</sub>	
	Back Porch	V_BP	18	18	t <sub>H</sub>	Note 2
	Pulse Width	VSW	1	1	t <sub>DCLK</sub>	

Note 1: Horizontal back porch time (H\_BP) is adjustable by setting register HBP; requirement of min. back porch and min. front porch time must be satisfied.

Note 2: Vertical back porch time (V\_BP) is adjustable by setting register VBP; requirement of min. back porch and min. front porch time must be satisfied.

3.4.2 8-bit Serial RGB Interface

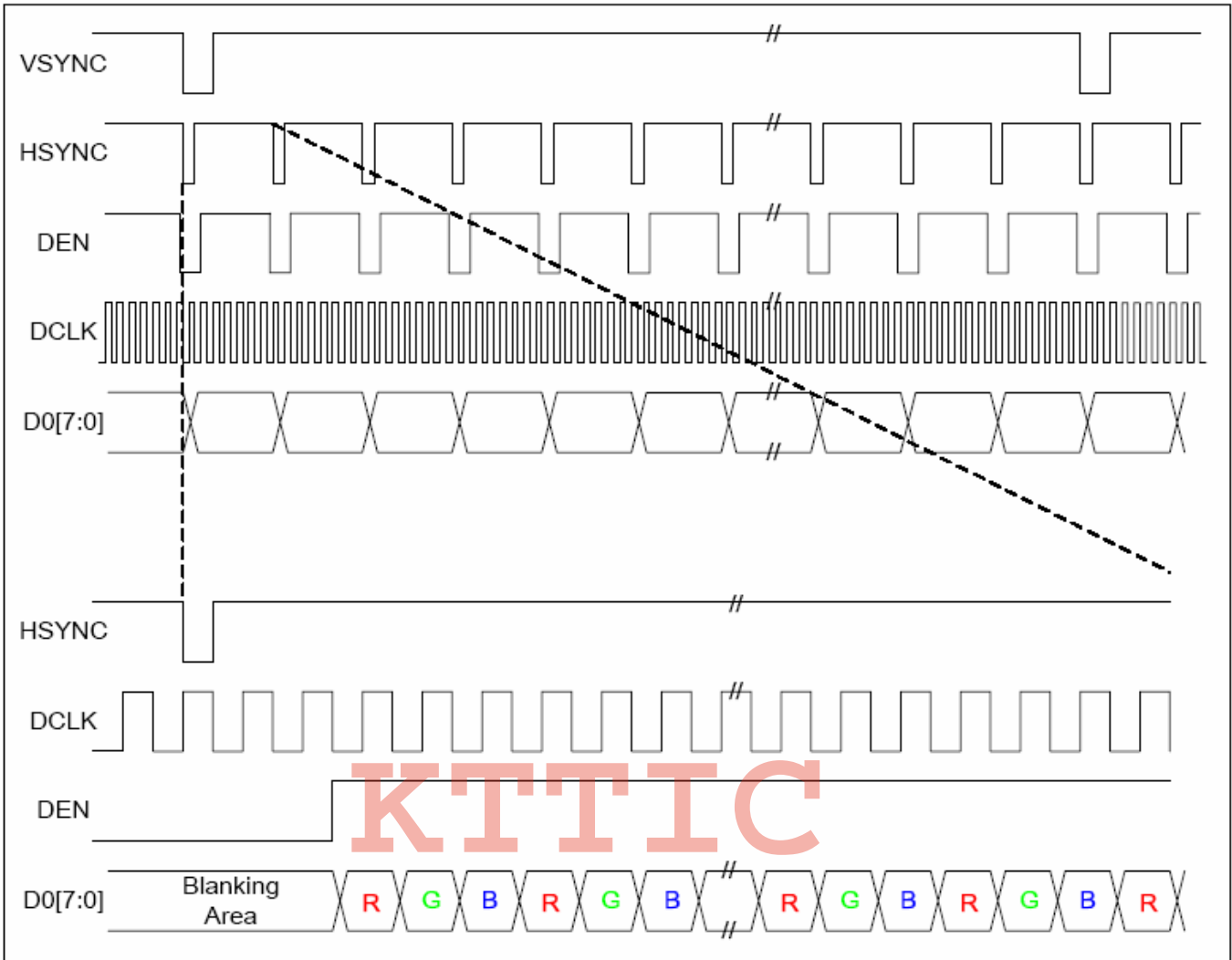

Figure4 Serial RGB Input Signal Timing

Parameter	Symbol	24MHz Mode	20MHz Mode	Unit.	Remark	
DCLK Frequency	1/t <sub>DCLK</sub>	24.535	20	MHz		
HSYNC	Period	t <sub>H</sub>	1560	1360	t <sub>DCLK</sub>	
	Display	H_DISP	960	960	t <sub>DCLK</sub>	
	Back Porch	H_BP	241	241	t <sub>DCLK</sub>	Note 1
	Front Porch	H_FP	-	-	t <sub>DCLK</sub>	
	Pulse Width	HSW	1	1	t <sub>DCLK</sub>	
VSYNC	Period	t <sub>V</sub>	262	245	t <sub>H</sub>	
	Display period	V_DISP	240	240	t <sub>H</sub>	
	Back Porch	V_BP	18	4	t <sub>H</sub>	Note 2
	Pulse Width	V_F	1	1	t <sub>DCLK</sub>	



Note 1: Horizontal back porch time (H\_BP) is adjustable by setting register HBP; requirement or min. back porch and min. front porch time must be satisfied.

Note 2: Vertical back porch time (V\_BP) is adjustable by setting register VBP; requirement or min. back porch and min. front porch time must be satisfied.

**3.4.3 ITU-R BT.656 Interface**

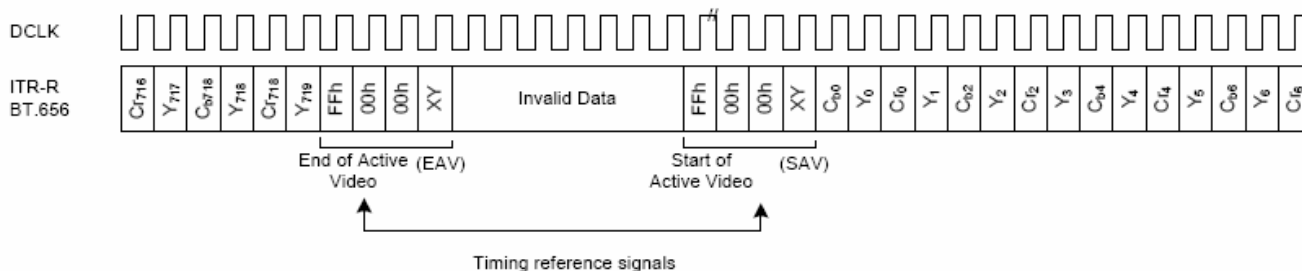

**Figure3 ITR-R BT.656 Input Signal**

Note1: FFh, 00h, 00h, XY signals are involved with the HSYNC, VSYNC and Field signals

- F: field indication
- V: Vertical blanking indication
- H: Horizontal blanking indication
- P3~P0: Protection bits
- $P3=V \oplus H, P2=F \oplus H, P1=F \oplus V, P0=F \oplus V \oplus H$

Data bit number	First Word (FFh)	Second Word (00h)	Third Word (00h)	Fourth Word (XY)
7(MSB)	1	0	0	1
6	1	0	0	F
5	1	0	0	V
4	1	0	0	H
3	1	0	0	P3
2	1	0	0	P2
1	1	0	0	P1
0(LSB)	1	0	0	P0

Note2: Horizontal blanking section consists of repeating pattern 80, 10, 80, 10 .

**ITU-R BT.656 timing specifications:**

Parameter		Symbol	360Mode	320Mode	Unit.	Remark
DCLK Frequency		1/t <sub>DCLK</sub>	27	24.54	MHz	
HSYNC	Period	t <sub>H</sub>	1716	1560	t <sub>DCLK</sub>	
	Display	H_DISP	1440	1280	t <sub>DCLK</sub>	
	Back Porch	H_BP	273	273	t <sub>DCLK</sub>	Note 1
	Front Porch	H_FP	-	-	t <sub>DCLK</sub>	
	Pulse Width	HSW	1	1	t <sub>DCLK</sub>	
VSYNC	Period	t <sub>V</sub>	262.5(312.5)	262.5(312.5)	t <sub>H</sub>	
	Valid Display period	V_DISP	240(288)	240(288)	t <sub>H</sub>	
	Back Porch	V_BP	18	18	t <sub>H</sub>	Note 2
	Pulse Width	VSW	1	1	t <sub>DCLK</sub>	

Note1: Horizontal back porch time (H\_BP) is adjustable by setting register HBP; requirement of min. back porch and min. front porch time must be satisfied.

Note2: Vertical back porch time (V\_BP) is adjustable by setting register VBP; requirement of min. back porch and min. front porch time must be satisfied.

**3.4.4 Reference circuit**

the positive(VGH) and negative(VGL) power supplies for LCD are generated through build-in DC-DC charge pump circuit, an elegant design with only several passive power-setting capacitors are required.

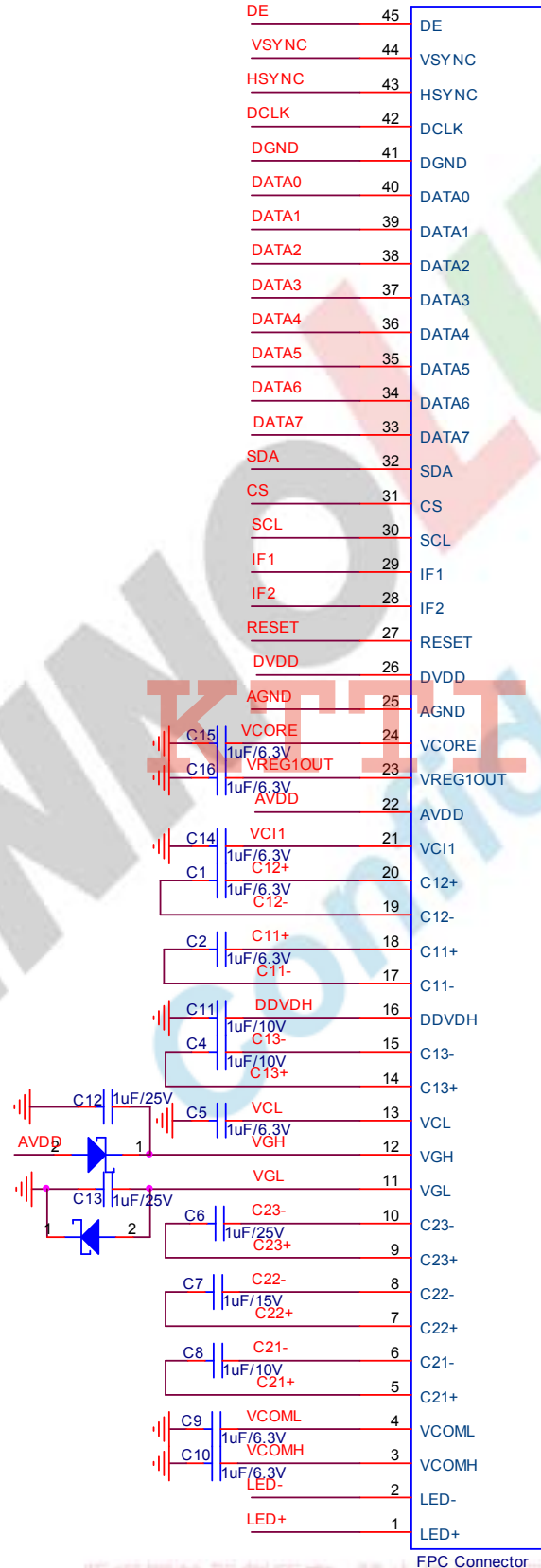

版權屬於群創所有，禁止任何未經授權的使用

### 3.4.5 SPI Timing Diagram

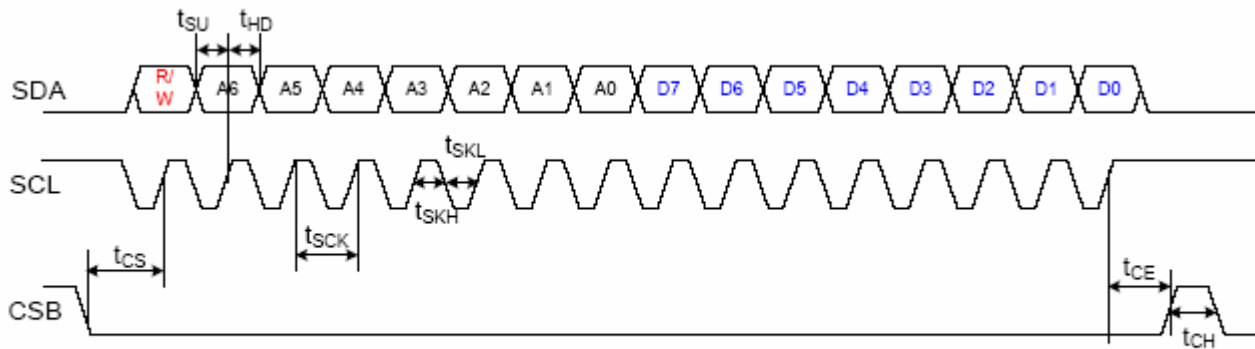

R/W=1, Read Mode

R/W=0, Write Mode

**SPI Timing Specification**

Items	Symbol	Min.	Typ.	Max.	Unit	Note
CSB to SCL Setup time	$T_{CS}$	50	-	-	ns	
CSB to SCL Hold time	$T_{CE}$	50	-	-	ns	
SCL Period	$T_{SCK}$	50	-	-	ns	
SCL High Period	$T_{SKH}$	25	-	-	ns	
SCL Low Period	$T_{SKL}$	25	-	-	ns	
Data Setup Time	$T_{SU}$	15	-	-	ns	
Data Hold Time	$T_{HD}$	15	-	-	ns	
CSB High Pulse Period	$T_{CH}$	50	-	-	ns	

**Note: SPI Control Registers List**

3-Wire Register		Register Description	
D[15:8]	Name	Value	Function Description
000001b	R01	0x1A	VCOM Amplitude
000011b	R03	0x09	VREG1OUT Voltage
000101b	R05	0x12	Power Setting
000110b	R06	0x0D	Entry Control
000111b	R07	0xEF	Power Control
001000b	R08	0x11	Vertical Back Porch
001001b	R09	0x80	Horizontal Back Porch
001010b	R0A	0x49	Polarity
001011b	R0B	0x05	Display
001100b	R0C	0x24	DC/DC
001101b	R0D	0x0A	Driving
001110b	R0E	0x08	CONTRAST
001111b	R0F	0x82	BRIGHT
010000b	R10	0xAA	Gamma1
010001b	R11	0x7C	Gamma2
010010b	R12	0xB6	Gamma3
010011b	R13	0xC5	Gamma4
010100b	R14	0xD5	Gamma5
010101b	R15	0xD8	Gamma6
010110b	R16	0xDC	Gamma7
010111b	R17	0x33	Gamma8
110000b	R30	0x09	Power
100010b	R42	0x40	OTP Program

## 4. Optical Specifications

Item	Symbol	Condition	Min.	Typ.	Max.	Unit	Remark
Viewing angle (CR≥10)	$\theta_L$	$\Phi=180^\circ$ (9 o'clock)	55	65	-	degree	Note 1
	$\theta_R$	$\Phi=0^\circ$ (3 o'clock)	55	65	-		
	$\theta_T$	$\Phi=90^\circ$ (12 o'clock)	35	45	-		
	$\theta_B$	$\Phi=270^\circ$ (6 o'clock)	55	65	-		
Response Time	$T_{ON}$	Normal $\theta=\Phi=0^\circ$	-	10	20	msec	Note 3
	$T_{OFF}$		-	15	30	msec	Note 3
Contrast ratio	CR		300	400	-	-	Note 4
Color chromaticity	$W_X$		0.26	0.31	0.36	-	Note 5
	$W_Y$		0.28	0.33	0.38	-	Note 6
Luminance	L		150	200	-	cd/m <sup>2</sup>	Note 6
Luminance uniformity	$Y_U$		70	75	-	%	Note 7

### Test Conditions:

1.  $AV_{DD}=3.3V$ ,  $DV_{DD}=3.3V$ ,  $I_L=20mA$  (Backlight current), the ambient temperature is  $25^\circ C$ .
2. The test systems refer to Note 2.

Note 1: Definition of viewing angle range

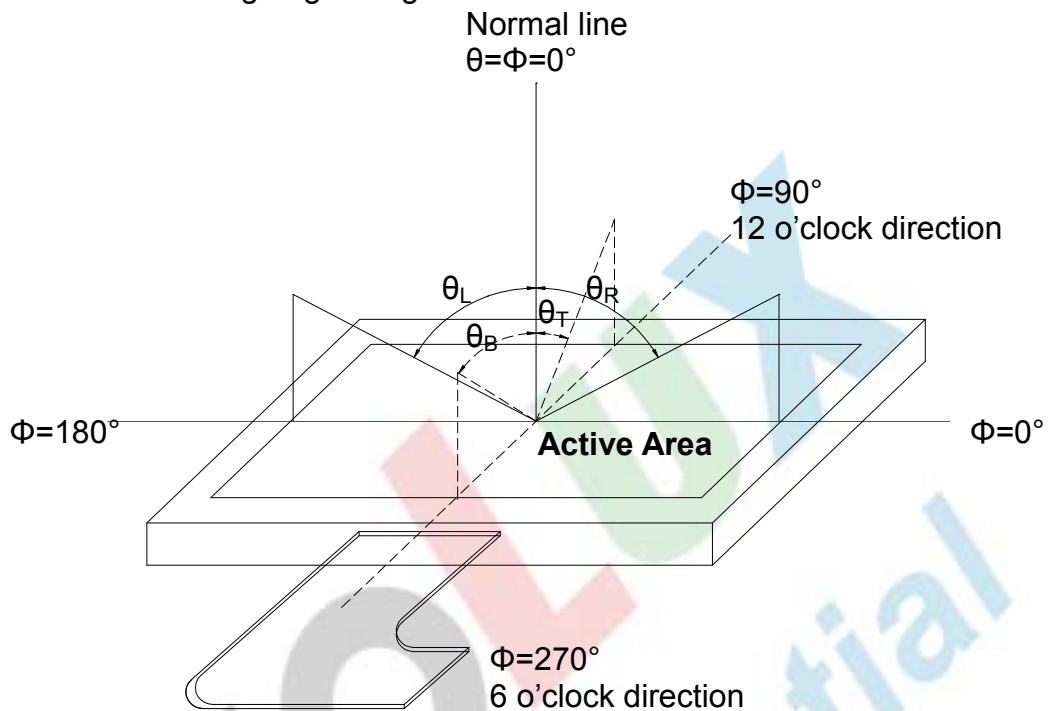

Fig. 5-1 Definition of viewing angle

Note 2: Definition of optical measurement system.

The optical characteristics should be measured in dark room. The optical properties are measured at the center point of the LCD screen. (Response time is measured by Photo detector TOPCON BM-7, other items are measured by BM-5A/Field of view:  $1^\circ$  /Height: 500mm.)



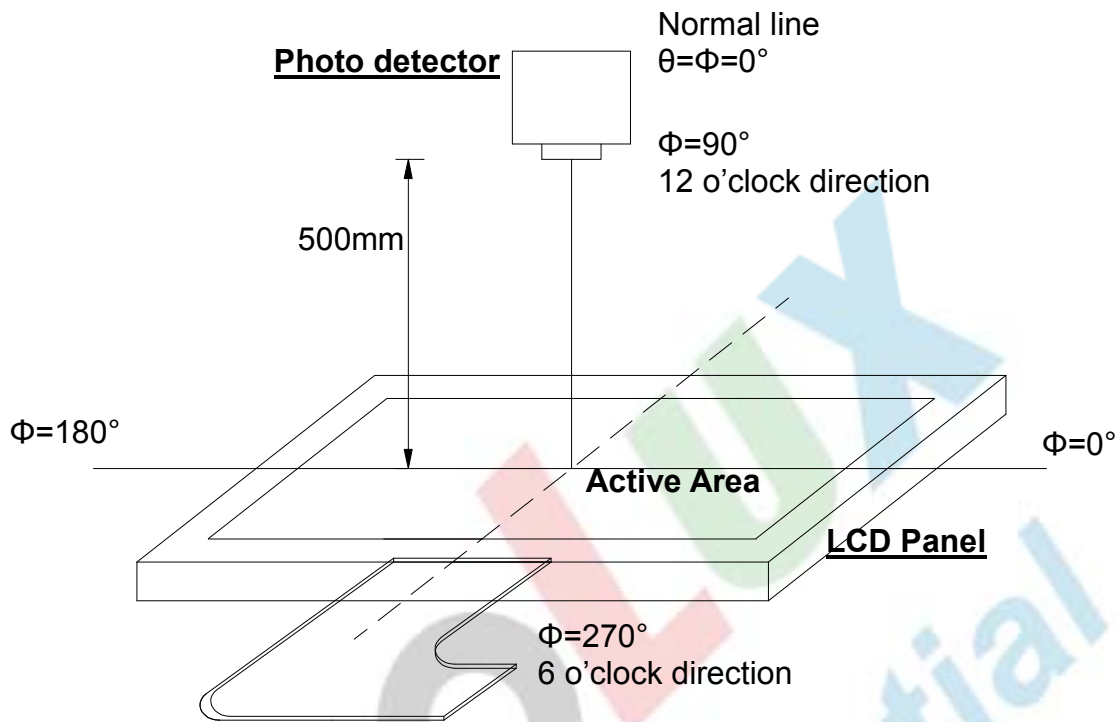

Fig. 5-2 Optical measurement system setup

Note 3: Definition of Response time

The response time is defined as the LCD optical switching time interval between "White" state and "Black" state. Rise time ( $T_{ON}$ ) is the time between photo detector output intensity changed from 90% to 10%. And fall time ( $T_{OFF}$ ) is the time between photo detector output intensity changed from 10% to 90%.

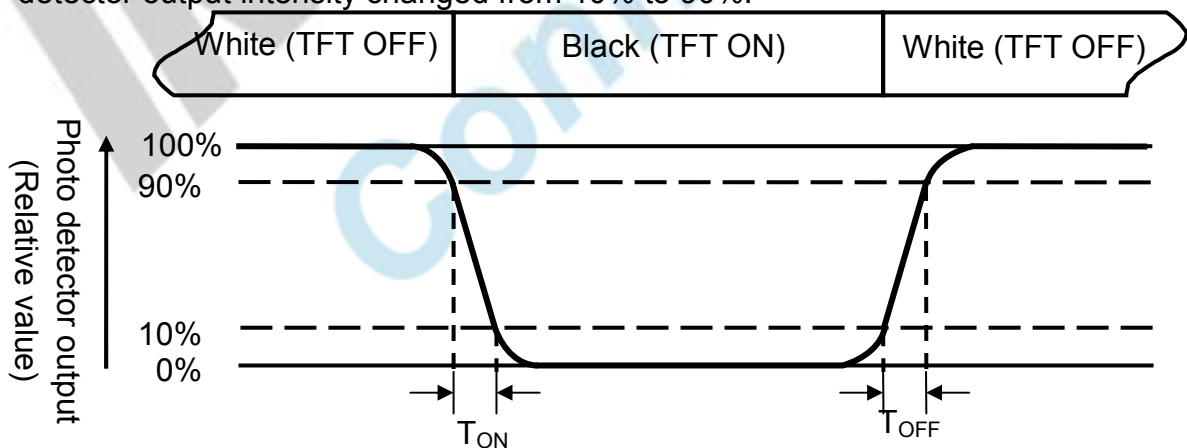

Fig. 5-3 Definition of response time

Note 4: Definition of contrast ratio

$$\text{Contrast ratio (CR)} = \frac{\text{Luminance measured when LCD is on the "White" state}}{\text{Luminance measured when LCD is on the "Black" state}}$$

Note 5: Definition of color chromaticity (CIE1931)  
Color coordinates measured at center point of LCD.

Note 6: All input terminals LCD panel must be ground when measuring the center area of the panel.

Note 7: Definition of Luminance Uniformity

To test for uniformity, the tested area, which is inside the active area, is divided into 3 rows and 3 columns. The measurement spot is placed at the center of each box.

$$\text{Luminance Uniformity (Yu)} = \frac{B_{min}}{B_{max}}$$

L-----Active area length      W----- Active area width

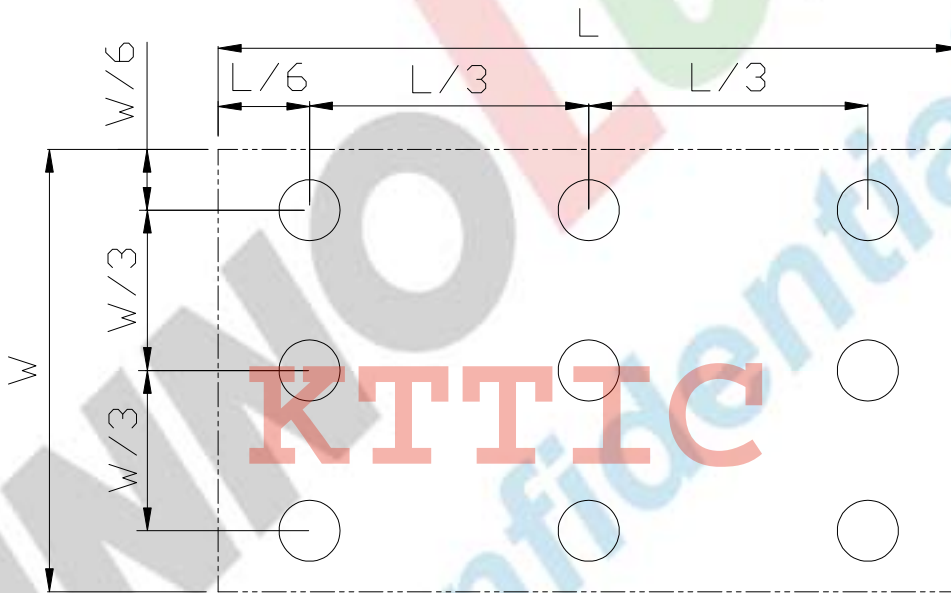

Fig. 5-4 Definition of uniformity

**B<sub>max</sub>**: The measured maximum luminance of all measurement position.

**B<sub>min</sub>**: The measured minimum luminance of all measurement position.



## 6. Handling Precautions

### 6.1. Safety

Liquid crystal is poisonous. Do not put it in your mouth. If liquid crystal touches your skin or clothes, wash it off immediately by using soap and water.

### 6.2. Handling

1. The LCD panel is plate glass. Do not subject the panel to mechanical shock or to excessive force on its surface.
2. The polarizer attached to the display is easily damaged. Please handle it carefully to avoid scratch or other damages.
3. To avoid contamination on the display surface, do not touch the module surface with bare hands.
4. Keep a space so that the LCD panels do not touch other components.
5. Put cover board such as acrylic board on the surface of LCD panel to protect panel from damages.
6. Transparent electrodes may be disconnected if you use the LCD panel under environmental conditions where the condensation of dew occurs.
7. Do not leave module in direct sunlight to avoid malfunction of the ICs.

### 6.3. Static Electricity

1. Be sure to ground module before turning on power or operating module.
2. Do not apply voltage which exceeds the absolute maximum rating value.

### 6.4. Storage

1. Store the module in a dark room where must keep at  $+25\pm 10^{\circ}\text{C}$  and 65%RH or less.
2. Do not store the module in surroundings containing organic solvent or corrosive gas.
3. Store the module in an anti-electrostatic container or bag.

### 6.5. Cleaning

1. Do not wipe the polarizer with dry cloth. It might cause scratch.
2. Only use a soft sloth with IPA to wipe the polarizer, other chemicals might permanent damage to the polarizer.

# 7. Mechanical Drawing

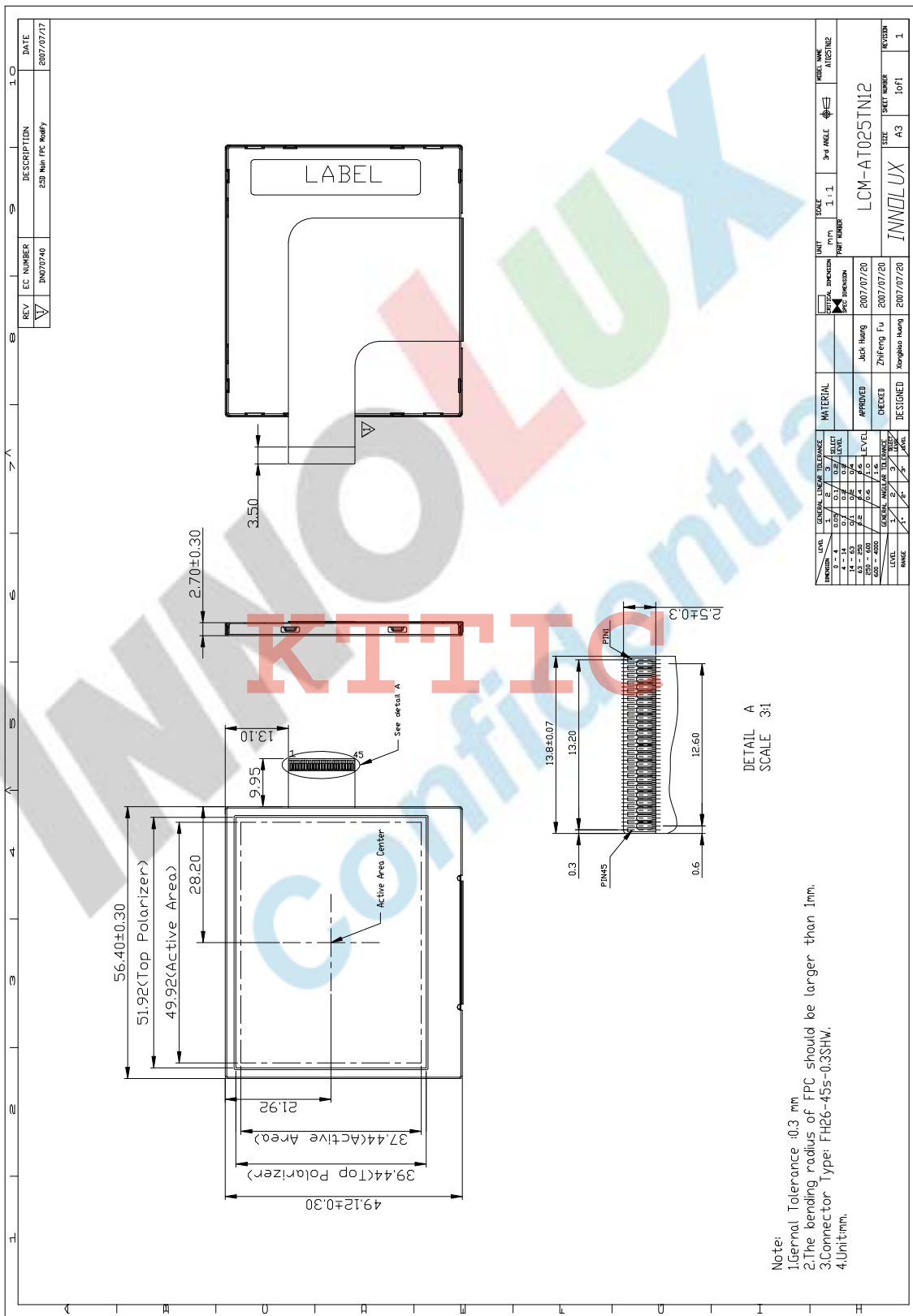

版權屬於群創所有，禁止任何未經授權的使用

## 8.Package Drawing

### 8.1 Packaging Material Table

No	Item	Model (Material)	Dimensions(mm)	Unit Weight(Kg)	Quantity	Remark
1	LCM module	AT025TN12	56.4×49.12×2.7	0.01684	480	
2	Tray	PET	345×245×18	0.09	40	Anti-static
3	Empty Tray	PET	345×245×18	0.09	2	Anti-static
4	DUST-PROOF BAG	PE	410×365×0.8	0.048	2	
5	Partition	CORRUGATED PAPER	340×254×230	0.22	2	
6	Carton	CORRUGATED PAPER	530×355×255	1.1	1	
7	Total weight	13.49±5%				

### 8.2 Packaging Quantity

(1) LCM quantity in per Tray: 12 pcs

(2) Total LCM quantity in per Carton: 2 set x 12pcs/tray x20 pcs tray/set = 480pcs



### 8.3 Packaging Drawing

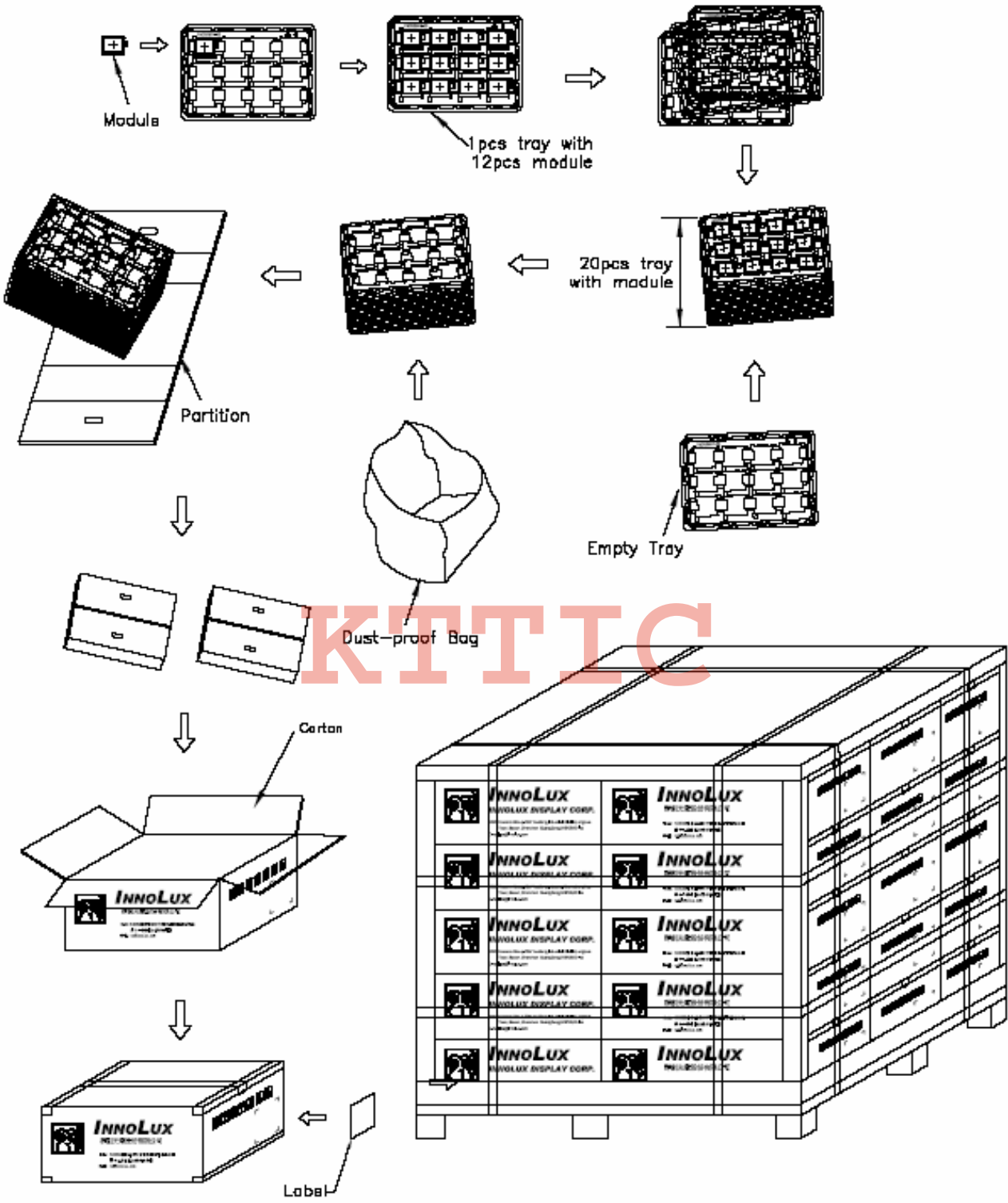



KTTIC <http://www.kttic.com>

KTTIC

<http://www.kttic.com>