



**3A High Current, Low Dropout Voltage Regulator**

*Adjustable, Fast Response Time*

**FEATURES**

- Adjustable Output Down To 1.25V
- 1% Output Accuracy
- Output Current of 3A
- Low Dropout Voltage of 370mV @ 3A
- Extremely Fast Transient Response
- Reverse-Battery Protection
- Zero Current Shutdown (5 pin version)
- Standard TO-220 and TO-263 Packages

**APPLICATIONS**

- Powering VGA & Sound Card
- PowerPC™ Supplies
- SMPS Post Regulator
- High Efficiency “Green” Computer Systems
- High Efficiency Linear Power Supplies
- Constant Current Regulators
- Adjustable Power Supplies
- Battery Charger

Refer to page 7 for pinouts.

*Now Available in Lead Free Packaging*

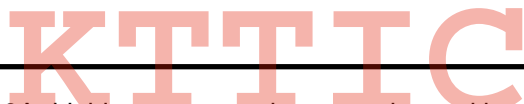

**DESCRIPTION**

The SPX29302A is a 3A, highly accurate voltage regulator with a low drop out voltage of 370mV (typical) @ 3A. These regulators are specifically designed for low voltage applications that require a low dropout voltage and a fast transient response. Fault protection features include over-current, reverse battery, and positive and negative voltage transients. On-Chip trimming adjusts the reference voltage to 1% initial accuracy.

The SPX29302A is offered in 5-pin TO-220 & TO-263 packages.

**TYPICAL APPLICATION S CIRCUIT**

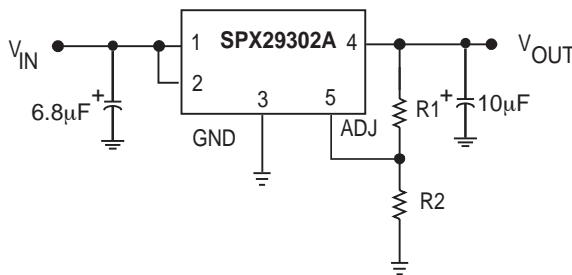

Figure 1. Adjustable Output Linear Regulator

## ABSOLUTE MAXIMUM RATINGS

Lead Temperature (soldering, 5 seconds)	.....260°C
Storage Temperature Range	.....-65°C to +150°C
Operating Junction Temperature Range	.....-40°C to +125°C
Input Voltage (Note 7)	..... 16V

## ELECTRICAL CHARACTERISTICS

(Note 1) at  $V_{IN}=V_{OUT}+1V$  and  $I_{OUT}=10mA$ ,  $C_{IN}=6.8\mu F$ ,  $C_{OUT}=10\mu F$ ,  $T_j=25^\circ C$ , unless otherwise specified. The Boldface applies over the junction temperature range.

SPX29302A					
PARAMETER	CONDITIONS	TYP	MIN	MAX	UNITS
Line Regulation	$I_{OUT}=10mA, (V_{OUT}+1V) \leq V_{IN} \leq 16V$	0.06		0.5	%
Load Regulation	$V_{IN}=V_{OUT}+5V, 10mA \leq I_{OUT} \leq I_{FL}$ (Note 2)	0.2		1	%
$\Delta V/\Delta T$	$V_{OUT}$ Temp Coefficient (Note 6)	<b>20</b>		<b>100</b>	ppm/°C
Dropout Voltage, except 1.8V, (Note 3)	$I_{OUT}=100mA$	50		<b>175</b>	mV
	$I_{OUT}=1.5A$	250			
	$I_{OUT}=3.0A$	370		<b>600</b>	
Ground Current (Note 5)	$I_{OUT}=1.5A, V_{IN}=V_{OUT}+1V$	10		<b>35</b>	mA
	$I_{OUT}=3.0A$	37			
Ground Pin Current at Dropout	$V_{IN}=0.5V$ less than specified $V_{OUT}$ , $I_{OUT}=10mA$	1.7			mA
Current Limit	$V_{OUT}=0V$ (Note 4)	4.0		5.0	A
Output Noise Voltage (10Hz to 100kHz) $I_L=100mA$	$C_L=10\mu F$	400			$\mu V_{RMS}$
	$C_L=33\mu F$	260			
Reference Voltage		1.240	1.228 <b>1.215</b>	1.252 <b>1.265</b>	$V_{MAX}$
Reference Voltage	(Note 8)		1.203	1.277	V
Adjust Pin Bias Current		40		80 <b>120</b>	nA
Reference Voltage Temp. Coeff.	(Note 7)	20			ppm/°C
Adjust Pin Bias Current Temp. Coeff.		0.1			nA/°C
<b>ENABLE Input</b>					
$\Delta$ Input Logic Voltage Low (OFF) High (ON)	$V_{IN}<10V$		<b>2.4</b>	<b>0.8</b>	V
ENABLE Input Pin	$V_{EN}=16V$	100		600 <b>750</b>	$\mu A$
	$V_{EN}=0.8V$			1 <b>2</b>	$\mu A$
Regulator Output Current in Shutdown	(Note 10)	10		<b>500</b>	$\mu A$
Thermal Resistance	TO-220 Junction to Case, at Tab	2			°C/W
	TO-220 Junction to Ambient	60			
	TO-263 Junction to Case, at Tab	2			
	TO-263 Junction to Ambient	60			

### NOTES:

Note 1: Maximum positive supply voltage of 20V must be of limited duration (<100msecond) < 1% and duty cycle of less than 1%. The maximum continuous supply voltage is 16V.

Note 2: Full load current ( $I_{FL}$ ) is defined as 3.0A.

Note 3: Dropout voltage is defined as the input to output differential when the output voltage drops to 99% of its nominal value.

Note 4:  $V_{IN} = V_{OUT} (NOMINAL) + 1V$ . For example, use  $V_{IN} = 4.3V$  for a 3.3V regulator. Employ pulse-testing procedures to minimize temperature rise.

Note 5: Ground pin current is the regulator quiescent current. The total current drawn from the source is the sum of the load current to the ground current.

Note 6: Output voltage temperature coefficient is defined as the worst case voltage change divided by the total temperature range

Note 7: Thermal regulation is defined as the change in output voltage at time T after a change in power dissipation is applied, excluding load / line regulation effects.

Specifications for a 200mA load pulse as  $V_{IN} = 16V$  (a 4W pulse) for  $t = 10ms$ .

Note 8:  $V_{REF} \leq V_{OUT} \leq (V_{IN}-1)$ ,  $2.3V \leq V_{IN} \leq 16V$ ,  $10mA \leq I_L \leq I_{FL}$ ,  $T_j \leq T_{jmax}$ .

Note 9: Comparator threshold is expressed in terms of a voltage differential at the Adjust terminal below the nominal reference voltage measured 6V input. To express these thresholds in terms of output voltage change, multiply the error amplifier gain =  $V_{OUT}/V_{REF} = (R1 + R2)/R2$ . For example, at a programmable output voltage of 5V, the Error output is guaranteed to go low when the output drops by  $95mV \times 5V / 1.240V = 38mV$ . Threshold remain constant as a percent of  $V_{OUT}$  as  $V_{OUT}$  is varied, with the dropout warning occurring at typically 5% below nominal, 7.7% guaranteed.

Note 10:  $V_{EN} \leq 0.8V$  and  $V_{IN} \leq 16V$ ,  $V_{OUT} = 0$ .

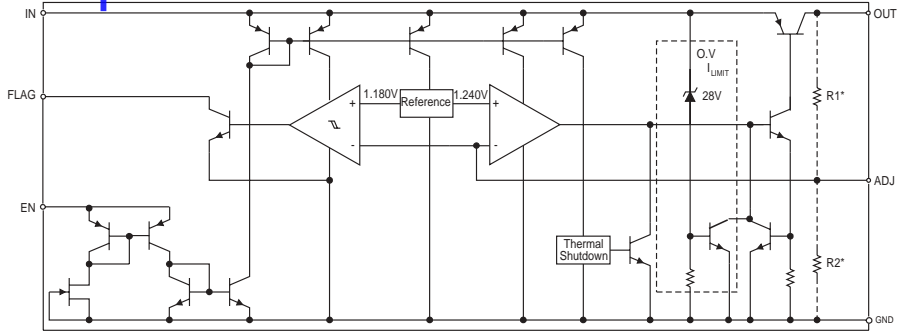

TYPICAL PERFORMANCE CHARACTERISTICS

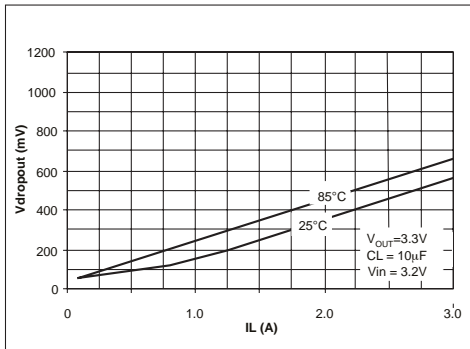

Figure 2. Dropout Voltage vs Load Current

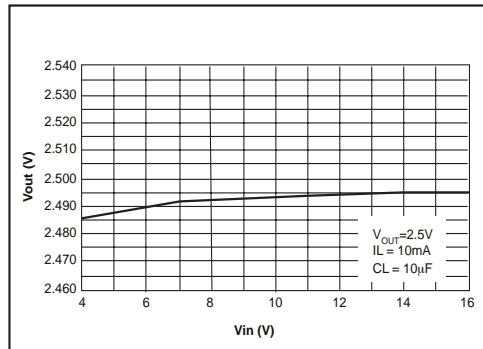

Figure 3. Line Regulation

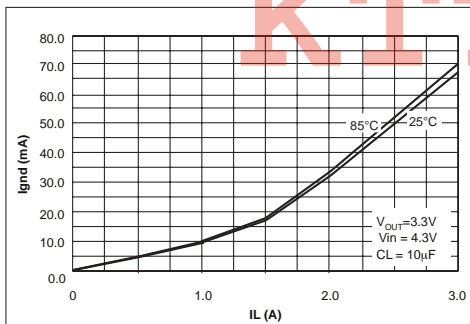

Figure 4. Ground Current vs Load Current

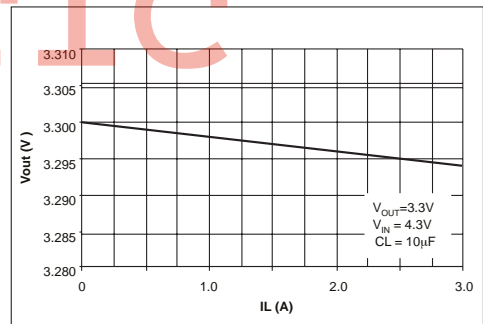

Figure 5. Load Regulation

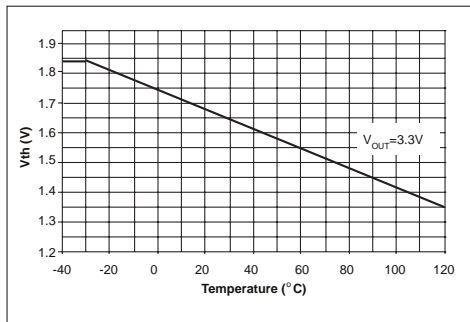

Figure 6. Enable Threshold vs Temperature

The SPX29302A incorporates protection against over-current faults, reversed load insertion, over temperature operation, and positive and negative transient voltage.

**Thermal Considerations**

Although the SPX29302A offers limiting circuitry for overload conditions, it is still necessary to insure that the maximum junction temperature is not exceeded in the application. Heat will flow through the lowest resistance path, the junction-to-case path. In order to insure the best thermal flow of the component, proper mounting is required.

**TO-220 Design Example:**

Assume that  $V_{IN} = 10V$ ,  $V_{OUT} = 5V$ ,  $I_{OUT} = 1.5A$ ,  $T_A = 50^{\circ}C$ ,  $\theta_{HA} = 1^{\circ}C/W$ ,  $\theta_{CH} = 2^{\circ}C/W$ , and  $\theta_{JC} = 3^{\circ}C/W$ , where:

- $T_A$  = ambient temperature,
- $\theta_{HA}$  = heatsink to ambient thermal resistance
- $\theta_{CH}$  = case to heatsink thermal resistance
- $\theta_{JC}$  = junction to case thermal resistance

The power calculated under these conditions is:

$$P_D = (V_{IN} - V_{OUT}) * I_{OUT} = 7.5W.$$

And the junction temperature is calculated as

$$T_J = T_A + P_D * (\theta_{HA} + \theta_{CH} + \theta_{JC}) \text{ or}$$

$$T_J = 50 + 7.5 * (1+2+3) = 95^{\circ}C$$

Reliable operation is insured below 125°C.

**Capacitor Requirements**

The output capacitor is needed to insure stability and minimize the output noise. The value of the capacitor varies with the load. However, a minimum value of 10µF aluminum capacitor will guarantee stability over all load conditions. A tantalum capacitor is recommended if a faster load transient

response is needed. If the power source has a high AC impedance, a 0.1µF ceramic capacitor between input & ground is recommended.

**Minimum Load Current**

To ensure a proper behavior of the regulator under light load, a minimum load of 5mA for SPX29302A is required.

**Adjustable Regulator Design**

The SPX29302A are adjustable regulators that can be programmed to any value between 1.25V and 16V using 2 resistors, R1 and R2. The relationship between the resistors is:

$$R1 = R2(V_{OUT}/1.240-1).$$

**Enable Input**

The SPX29302A has an Enable function that switches the regulator on and off. Its thresholds is TTL compatible. When the regulator is active, approximately 20 uA flows through the Enable pin.

**Typical Application Circuits**

Figure 1 represents an adjustable output linear regulator. The values of R1 and R2 set the output voltage value as follows:

$$V_{OUT} = V_{REF} * [1 + (R1/R2)].$$

For best results, the total series resistance should be small enough to pass a minimum regulator load current of 5 mA. A minimum value of 10kohms is recommended for R2 with a range between 10kohms and 47 kohms.

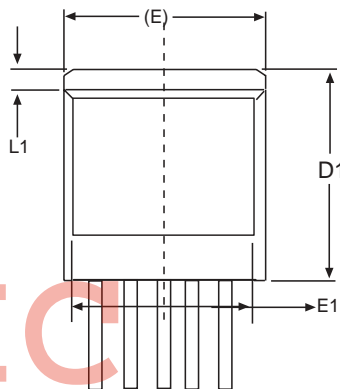
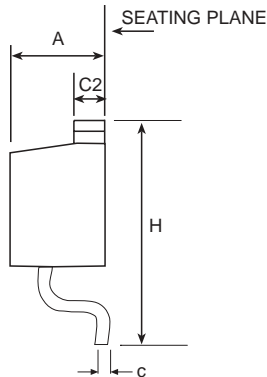
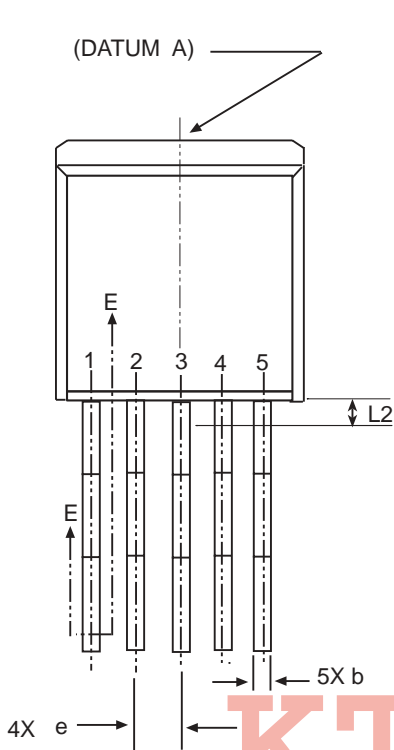

5 PIN TO-263 JEDEC TO-263 (BB) Variation	Dimensions in (mm)		
	MIN	NOM	MAX
A	.160	-	.190
A1	0	-	.010
b	.020	-	.039
c	.015	-	.029
c2	.045	-	.023
D1	.270	-	-
E	.380	-	.420
E1	.245	-	-
e	.067 BSC		
H	.575	-	.625
L	.070	-	.110
L1	-	-	.066
L2	-	-	.070
L3	.010 BSC		

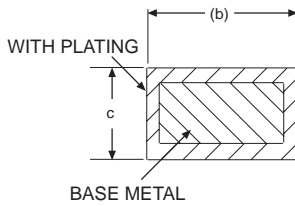
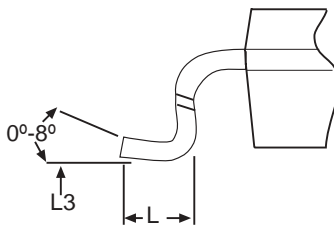

CONTACT AREA

**5 PIN TO-263**



TO-263-5 Package (T5)

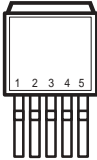

Top View

- SPX29302A  
 1) ENABLE  
 2) INPUT  
 3) GND  
 4) OUTPUT  
 5) ADJUST

TO-220-5 Package (U5)

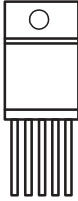

Top View

- SPX29302A  
 1) ENABLE  
 2) INPUT  
 3) GND  
 4) OUTPUT  
 5) ADJUST

\*Tab is internally connected to GND

**ORDERING INFORMATION**

PART NUMBER	ACCURACY	TOP MARK	OUTPUT VOLTAGE	PACKAGE
SPX29302AT5	1.0%	29302AT5YYWW	Adj	5 lead TO-263
SPX29302AT5/TR	1.0%	29302AT5YYWW	Adj	5 lead TO-263
SPX29302AU5	1.0%	29302AU5YYWW	Adj	5 lead TO-220

Available in lead free packaging. To order add "-L" suffix to part number.

Example: SPX29302A/TR = standard; SP6685ER-L/TR = lead free

/TR = Tape and Reel

Pack quantity is 500 for TO-263.



ANALOG EXCELLENCE

**Sipex Corporation**

**Headquarters and Sales Office**  
 233 South Hillview Drive  
 Milpitas, CA 95035  
 TEL: (408) 934-7500  
 FAX: (408) 935-7600

Sipex Corporation reserves the right to make changes to any products described herein. Sipex does not assume any liability arising out of the application or use of any product or circuit described herein; neither does it convey any license under its patent rights nor the rights of others.