

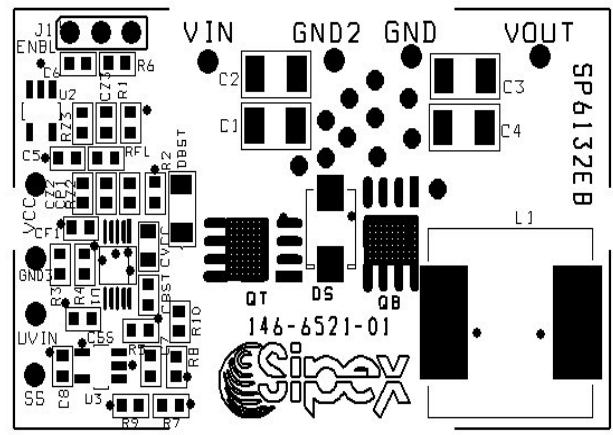

SP6132 Evaluation Board Manual

- Easy Evaluation for the SP6132 12V Input, 0 to 10A Output Synchronous Buck Converter
- Precision 0.80V with $\pm 1\%$ High Accuracy Reference.
- UVIN and Output Dead Short Circuit Shutdown Protection Features.
- High Efficiency: 94%
- Feature Rich: UVIN, Programmable Softstart, External VCC Supply and Output Dead Short Circuit Shutdown Protection.



SP6132EB SCHEMATIC

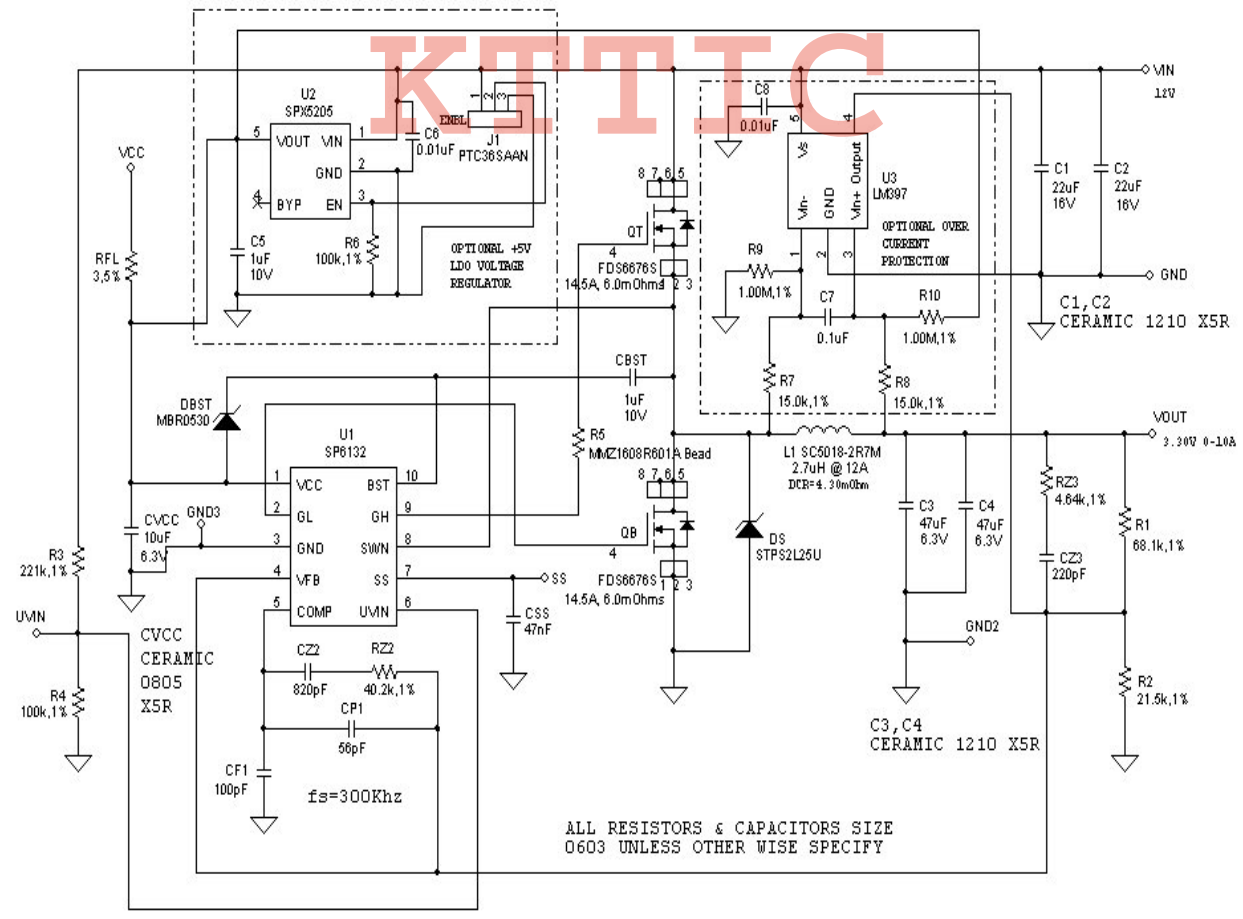

1) Powering Up the SP6132 Circuit

Connect the SP6132 Evaluation Board with an external +12V power supply. Connect with short leads and large diameter wire directly to the “VIN” and “GND” posts. Connect a Load between the VOUT and GND posts, again using short leads with large diameter wire to minimize inductance and voltage drops.

2) Measuring Output Load Characteristics

It's best to GND reference scope and digital meters using the Star GND post in the center of the board. VOUT ripple can best be seen touching probe tip to the pad for COUT and scope GND collar touching Star GND post – avoid a GND lead on the scope which will increase noise pickup.

3) Using the Evaluation Board with Different Output Voltages

While the SP6132 Evaluation Board has been tested and delivered with the output set to 3.30V, by simply changing one resistor, R2, the SP6132 can be set to other output voltages. The relationship in the following formula is based on a voltage divider from the output to the feedback pin VFB, which is set to an internal reference voltage of 0.80V. Standard 1% metal film resistors of surface mount size 0603 are recommended.

$$V_{out} = 0.80V (R1 / R2 + 1) \text{ or } R2 = R1 / [(V_{out} / 0.80V) - 1]$$

Where $R1 = 68.1K\Omega$ and for $V_{out} = 0.80V$ setting, simply remove R2 from the board. Furthermore, one could select the value of R1 and R2 combination to meet the exact output voltage setting by restricting R1 resistance range such that $50K\Omega \leq R1 \leq 100K\Omega$ for overall system loop stability.

Note that since the SP6132CU Evaluation Board design was optimized for 12V down conversion to 3.30V, changes of output voltage and/or input voltage will alter performance from the data given in the Power Supply Data section. **In addition, the SP6132CU provides short circuit protection by sensing Vout at GND however for a better and robust current limit a comparator circuit could be used as shown on the SP6132EB Schematic.**

POWER SUPPLY DATA

The SP6132 is designed with a very accurate 1.0% reference over line, load and temperature. Figure 1 data shows a typical SP6132CU Evaluation Board Efficiency plot, with efficiencies to 94% and output currents to 10A. SP6132CU Load Regulation shown in Figure 2 shows only 0.3% change in output voltage from no load to 10A load. Figures 3 and 4 illustrate a 0A to 5.0A and 5.0A to 10A Load Step. Start-up Response in Figures 5, 6 and 7 show a controlled start-up with different output load behavior when power is applied where the input current rises smoothly as the Softstart ramp increases. In Figure 8 the SP6132CU is configured for hiccup mode in response to an output dead short circuit condition and will Softstart until the over-load is removed. Figure 9 and 10 show output voltage ripple less than 60mV at no load to 10A load.

While data on individual power supply boards may vary, the capability of the SP6132 of achieving high accuracy over a range of load conditions shown here is quite impressive and desirable for accurate power supply design.

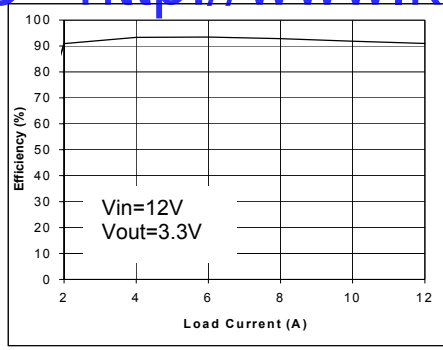

Figure 1. Efficiency vs Load

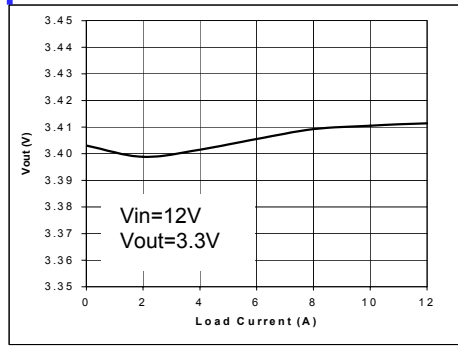

Figure 2. Load Regulation

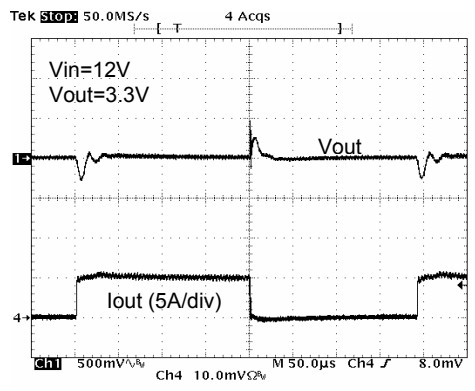

Figure 3. Load Step Response: 0->5A

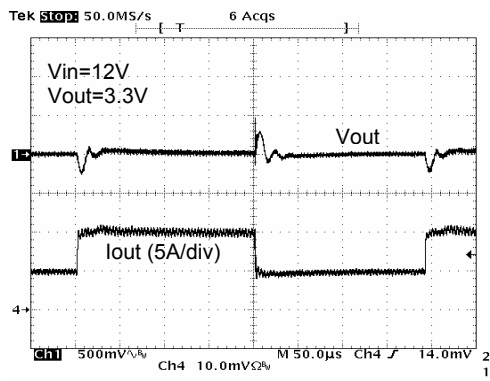

Figure 4. Load Step Response: 5->10A

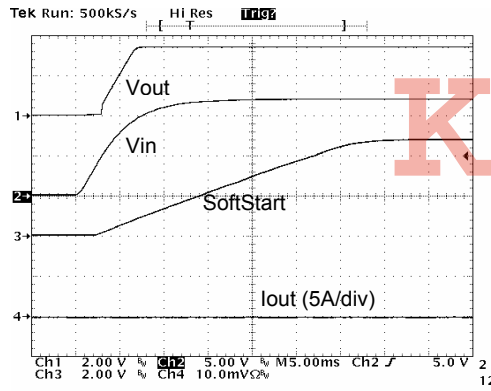

Figure 5. Start-Up Response: No Load

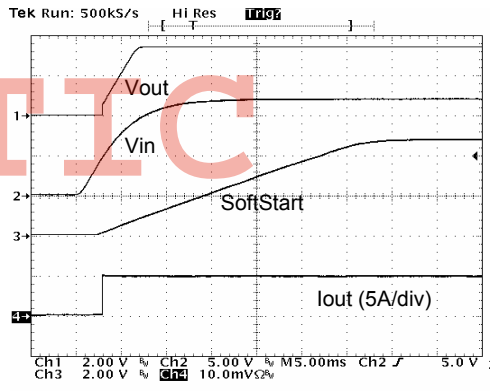

Figure 6. Start-Up Response: 5A Load

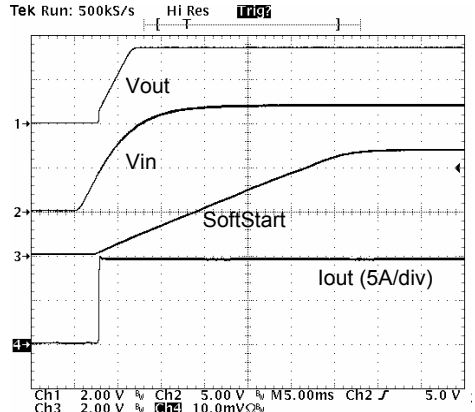

Figure 7. Start-Up Response: 10A Load

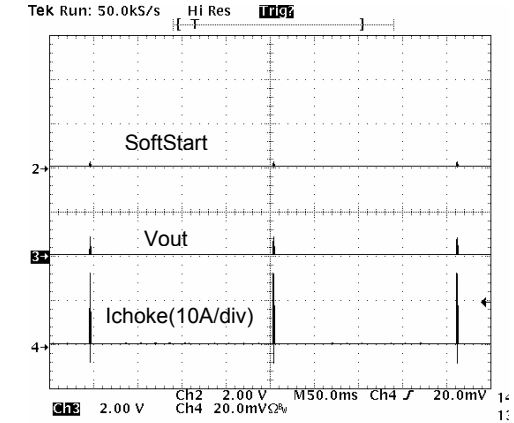
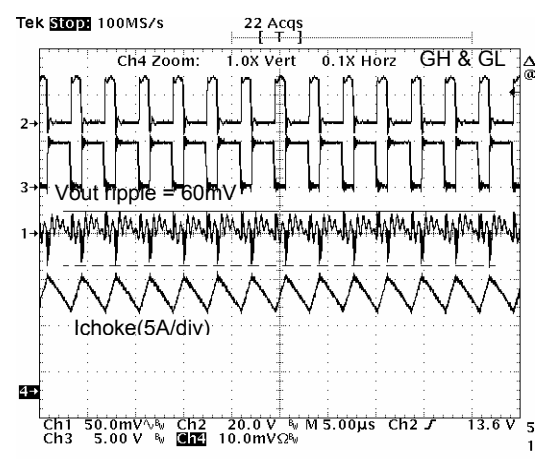
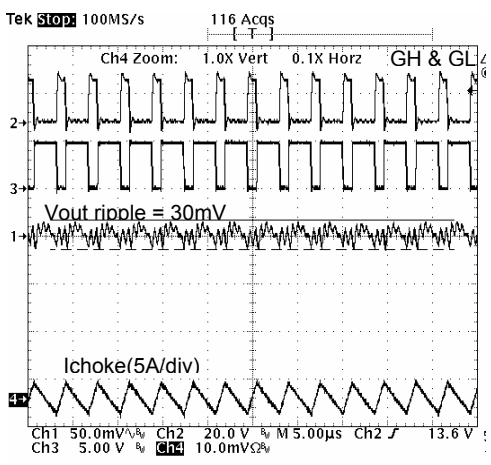
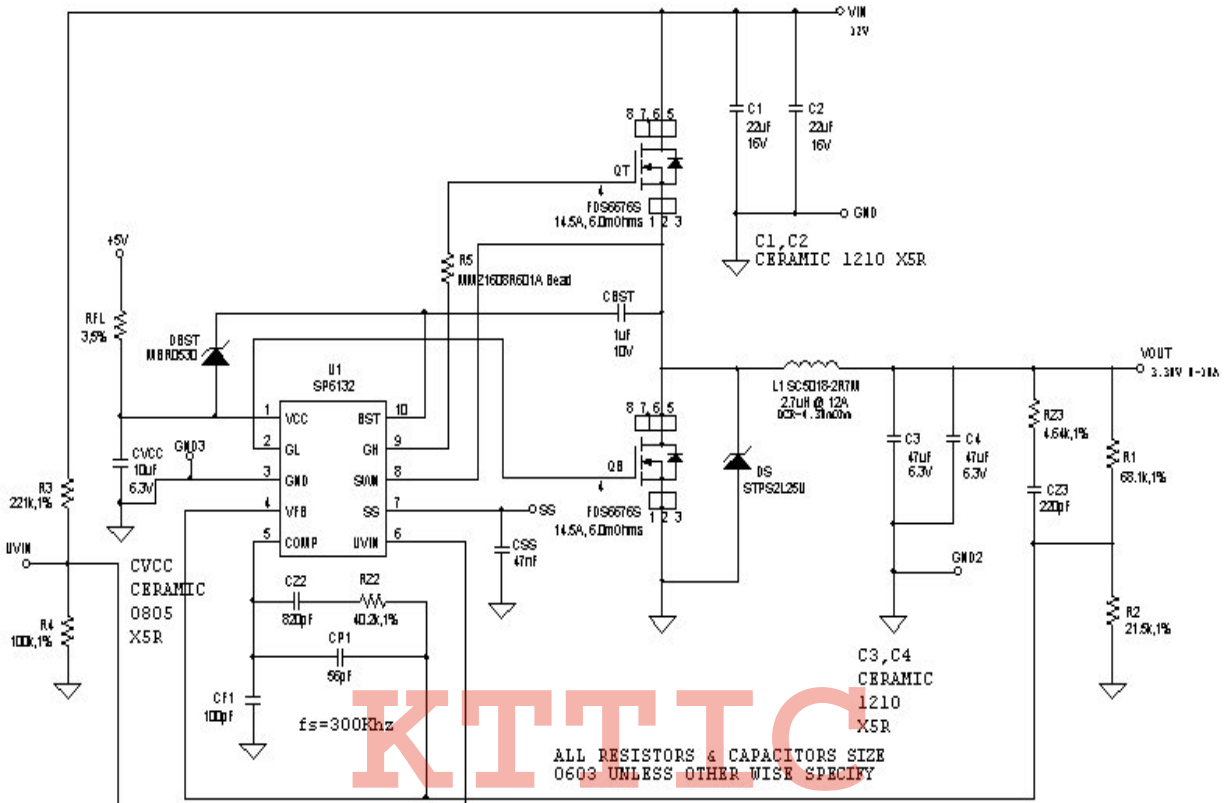

Figure 8. Output Load Short Circuit

In this application example, the SP6132CU is powered by an external +5V bias supply which has a current consumption of 20mA Maximum. If this supply is not available, it is recommended to use the Sipex SPX5205 Low-Noise LDO Voltage Regulator which is included on the 6132CU Evaluation Board.



The SP6132EB is design for ease of a quick modification to accommodate for applications that required both different input/output load voltage and current levels. The change such that modification requiring only simple few on board components direct replacement as show on the following Table 1.

Table 1: SP6132EB Suggested Components

SP6132EB Suggested Components for Different Input Voltage and Output Current Applications						
QT, QB	DS	L1	C1, C2	C3, C4	R4	R5
5V Input, 2A Output						
Fairchild Semi FDS6162N3 20V, 21A, 4.5mOhm Layout Size SO-8	OUT	Easy Magnet SD75-6R8M 6.8uH, 2.54Arms,46mOhm Layout Size 7.8 x 7.0 mm	TDK C3225X5R0J476M 47uF Ceramic X5R 6.3V Layout Size 1210 C1 IN and C2 OUT	TDK C3225X5R0J476M 47uF Ceramic X5R 6.3V Layout Size 1210 C3 IN and C4 OUT	Panasonic ERJ-3EKF3322V 332K Ohm, 1% Layout Size 0603	Yageo America 9C06031A0R0JLHFT 0.0 Ohm, 1% Layout Size 0603
5V Input, 0 to 15A Output						
Fairchild Semi FDS6162N3 20V, 21A, 4.5mOhm Layout Size SO-8	OUT	Easy Magnet SC5018-2R7M 2.7uH, 15.0A, 4.10mOhm Layout Size 12.6 x 12.6 mm	TDK C3225X5R0J476M 47uF Ceramic X5R 6.3V Layout Size 1210	TDK C3225X5R0J476M 47uF Ceramic X5R 6.3V Layout Size 1210	Panasonic ERJ-3EKF3322V 332K Ohm, 1% Layout Size 0603	Yageo America 9C06031A0R0JLHFT 0.0 Ohm, 1% Layout Size 0603
12V Input, 2A Output						
Fairchild Semi FDS7088N3 30V, 21A, 5mOhm Layout Size SO-8	IN	Easy Magnet SD75-6R8M 6.8uH, 2.54Arms,46mOhm Layout Size 7.8 x 7.0 mm	TDK C3225X5R1C226M 22uF Ceramic X5R 16V Layout Size 1210 C1 IN and C2 OUT	TDK C3225X5R0J476M 47uF Ceramic X5R 6.3V Layout Size 1210 C3 IN and C4 OUT	Panasonic ERJ-3EKF1003V 100K Ohm, 1% Layout Size 0603	TDK MMZ1608R601A High Freq Bead Filter Layout Size 0603
12V Input, 0 to 15A Output						
Fairchild Semi FDS7088N3 30V, 21A, 5mOhm Layout Size SO-8	IN	Easy Magnet SC5018-2R7M 2.7uH, 15.0A, 4.10mOhm Layout Size 12.6 x 12.6 mm	TDK C3225X5R1C226M 22uF Ceramic X5R 16V Layout Size 1210	TDK C3225X5R0J476M 47uF Ceramic X5R 6.3V Layout Size 1210	Panasonic ERJ-3EKF1003V 100K Ohm, 1% Layout Size 0603	TDK MMZ1608R601A High Freq Bead Filter Layout Size 0603

NOTES:

Referring to +5V Bias Supply Application Schematic, **DS** (STPS2L25U) **OUT** meaning the application is not required to installed and vice versa. The same argument is also applying both to **C2, C4 OUT** and **C2, C4 IN**.

The open loop gain of the SP6132EB can be divided into the gain of the error amplifier **Gamp(s)**, PWM modulator **Gpwm**, buck converter output stage **Gout(s)**, and feedback resistor divider **Gfbk**. In order to crossover at the selecting frequency **fco**, the gain of the error amplifier has to compensate for the attenuation caused by the rest of the loop at this frequency. The goal of loop compensation is to manipulate the open loop frequency response such that its gain crosses over 0dB at a slope of -20dB/dec . The open loop crossover frequency should be higher than the ESR zero of the output capacitors but less than 1/5 of the switching frequency **fs** to insure proper operation. Since the SP6132EB is designed with a Ceramic Type output capacitors, a Type III compensation circuit is required to give a phase boost of 180° in order to counteract the effects of the output **LC** under damped resonance double pole frequency.

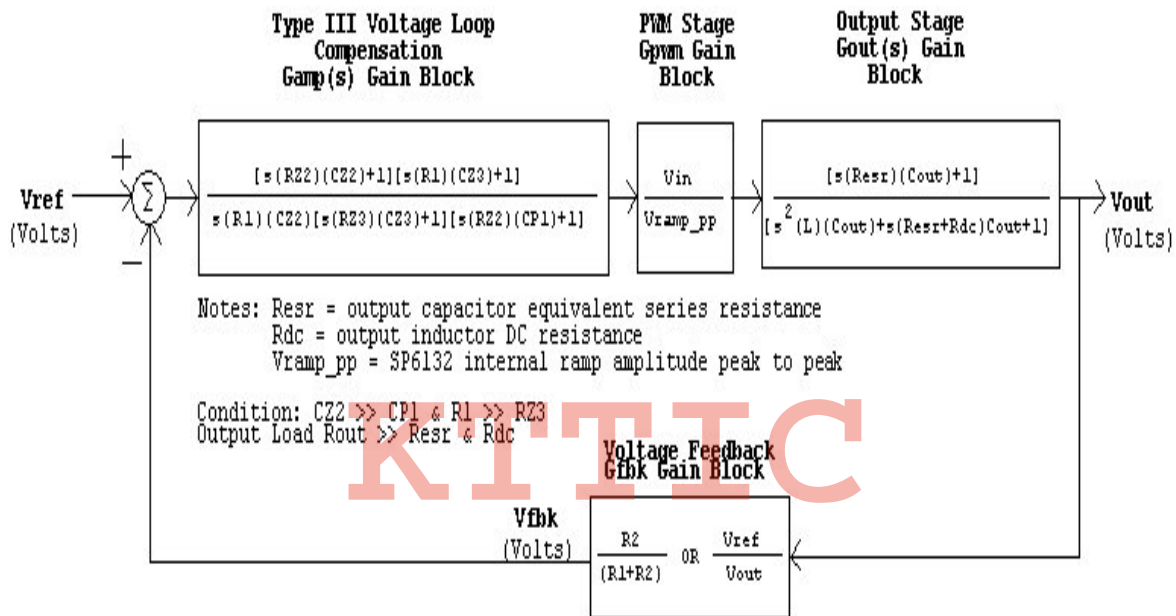

Figure 11. SP6132EB Voltage Mode Control Loop with Loop Dynamic

The simple guidelines for positioning the poles and zeros and for calculating the component values for a Type III compensation are as follows.

- a. Choose **fco** = $f_s / 5$
- b. Calculate **fp_LC**
 $f_{p_LC} = 1 / 2\pi [(L) (C)]^{1/2}$
- c. Calculate **fz_ESR**
 $f_{z_ESR} = 1 / 2\pi (Resr) (Cout)$
- d. Select **R1** component value such that $50k\Omega \leq R1 \leq 100k\Omega$
- e. Calculate **R2** base on the desired Vout
 $R2 = R1 / [(Vout / 0.80V) - 1]$

- f. Select the ratio of **Rz2 / R1** gain for the desired gain bandwidth
 $Rz2 = (R1) (Vramp_pp / Vin) (fco / fp_LC)$
- g. Calculate **Cz2** by placing the zero at 1/2 of the output filter pole frequency
 $Cz2 = 1 / \pi (Rz2) (fp_LC)$
- h. Calculate **Cp1** by placing the first pole at ESR zero frequency
 $Cp1 = 1 / 2\pi (Rz2) (fz_ESR)$
- i. Calculate **Rz3** by setting the second pole at 1/2 of the switching frequency and the second zero at the output filter double pole frequency
 $Rz3 = 2 (R1) (fp_LC) / fs$
- j. Calculate **Cz3** from **Rz3** component value above
 $Cz3 = 1 / \pi (Rz3) (fs)$
- k. Choose $100pF \leq Cf1 \leq 220pF$ to stabilize the SP6132CU internal Error Amplify

As a particular example, consider for the following SP6132EB with a type III Voltage Loop Compensation component selections:

$Vin = 5$ to $12V$

$Vout = 3.30V$ @ 0 to $10A$ load

Select **L = 2.7uH** => yield $\approx 20\%$ of maximum $10A$ output current ripple.

Select **Cout = 2x47uF** Ceramic capacitors ($Resr \approx 2m\Omega$)

fs = $300kHz$ SP6132CU internal Oscillator Frequency

Vramp_pp = $1.0V$ SP6132CU internal Ramp Peak to Peak Amplitude

Step by step design procedures:

- a. **fco** = $300kHz / 5 = 60kHz$
- b. **fp_LC** = $1 / 2\pi [(2.7uH)(2)(47uF)]^{1/2} \cong 10kHz$
- c. **fz_ESR** = $1 / 2\pi (2m\Omega)(2)(47uF) \approx 850kHz$
- d. **R1** = $68.1k\Omega$, 1%
- e. **R2** = $68.1k\Omega / [(3.30V / 0.80V) - 1] \cong 21.5k\Omega$, 1%
- f. **Rz2** = $68.1k\Omega (1.0V / 12V) (60kHz / 10kHz) \approx 40.2k\Omega$, 1%
- g. **Cz2** = $1 / \pi (40.2k\Omega) (10kHz) \approx 820pF$, COG
- h. **Cp1** = $1 / 2\pi (40.2k\Omega) (850kHz) \approx 5pF$ => Select **Cp1** = $56pF$ for noise filtering
- i. **Rz3** = $2 (68.1k\Omega) (10kHz) / 300kHz \approx 4.64k\Omega$, 1%
- j. **Cz3** = $1 / \pi (4.64k\Omega) (300kHz) \cong 220pF$, COG
- k. **Cf1** = $100pF$ to stabilize SP6132CU internal Error Amplify

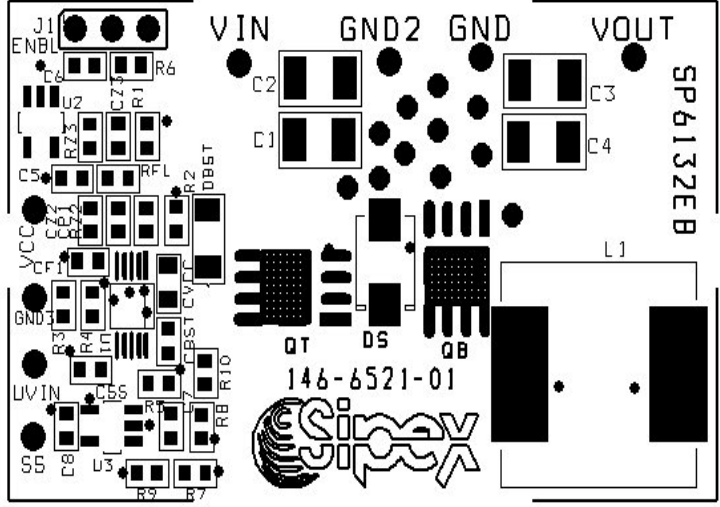

Figure 11. SP6132EB Component Placement

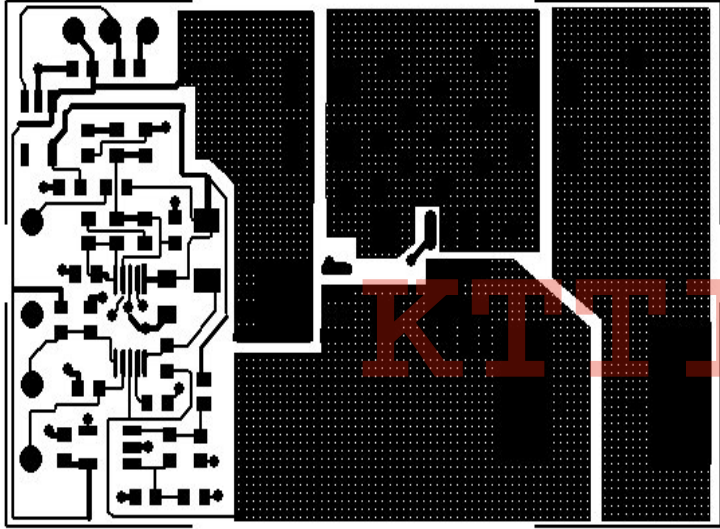

Figure 12. SP6132EB PC Layout Top Side

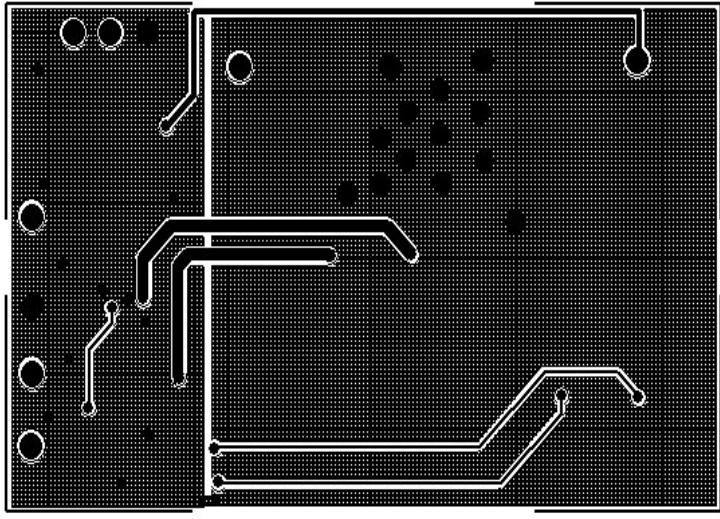

Figure 13. SP6132EB PC Layout Bottom Side

Table 2: SP6132EB List of Materials

SP6132 Evaluation Board List of Materials						
Line No.	Ref. Des.	Qty.	Manuf.	Manuf. Part Number	Layout Size	Component
1	PCB	1	Sipex	146-6521-01	1.75"X2.75"	SP6132 Eval PCB
2	U1	1	Sipex	SP6132EB	MSOP-10	2-15A Any-FET Buck Ctrl
3	U2	1	Sipex	SP5205M5-5.0	SOT-23-5	150mA LDO Voltage Reg
4	U3	1	National Semi	LM397MF	SOT-23-5	Voltage Comparator
5	QT, QB	2	Fairchild Semi	FDS6676S	SO-8	NFET
6	DS	1	STMicroelectronics	STPS2L25U	SMB	2A Schottky 10A RMS
7	DBST	1	ON-Semi	MBR0530	SOD-123	0.5A Schottky
8	L1	1	Easy Magnet	SC5018-2R7M	12.6X12.6mm	2.70uH Coil 12A 4.30mohm
9	C3, C4	2	TDK	C3225X5R0J476M	1210	47uF Ceramic X5R 6.3V
10	C1, C2	2	TDK	C3225X5R1C226M	1210	22uF Ceramic X5R 16V
11	CVCC	1	TDK	C2012X5R0J106M	0805	10uF Ceramic X5R 6.3V
12	C6, C8	2	TDK	C1608X5R1C103K	0603	0.01uF Ceramic X5R 16V
13	C5, CBST	2	TDK	C1608X5R1A105K	0603	1.0uF Ceramic X5R 10V
14	C7	1	TDK	C1608X7R1H104K	0603	0.1uF Ceramic X7R 50V
15	CSS	1	TDK	C1608X7R1H473K	0603	47,000pF Ceramic X7R 50V
16	CP1	1	TDK	C1608COG1H560J	0603	56pF Ceramic COG 50V
17	CZ2	1	TDK	C1608COG1H821J	0603	820pF Ceramic COG 50V
18	CF1	1	TDK	C1608COG1H101J	0603	100pF Ceramic COG 50V
19	CZ3	1	TDK	C1608COG1H221J	0603	220pF Ceramic COG 50V
20	R5	1	TDK	MMZ1608R601A	0603	High Frequency Bead Filter
21	RZ2	1	Panasonic	ERJ-3EKF4022V	0603	40.2K Ohm Thick Film Res 1%
22	R2	1	Panasonic	ERJ-3EKF2152V	0603	21.5K Ohm Thick Film Res 1%
23	RZ3	1	Panasonic	ERJ-3EKF4641V	0603	4.64K Ohm Thick Film Res 1%
24	R1	1	Panasonic	ERJ-3EKF6812V	0603	68.1K Ohm Thick Film Res 1%
25	R3	1	Panasonic	ERJ-3EKF2212V	0603	221K Ohm Thick Film Res 1%
26	R4, R6	2	Panasonic	ERJ-3EKF1003V	0603	100K Ohm Thick Film res 1%
27	R7, R8	2	Panasonic	ERJ-3EKF1502V	0603	15.0K Ohm Thick Film Res 1%
28	R9, R10	2	Panasonic	ERJ-3EKF1004V	0603	1.00M Ohm Thick Film Res 1%
29	RFL	1	Yageo America	9C06031A3R0JLHFT	0603	3.0 Ohm Thick Film Res 5%
30	J1	1	Sullins	PTC36SAAN	.32x.12	36-Pin (3x12) Header
31	(J1)	1	Sullins	STC02SYAN	.2x.1	Shunt
32	VIN, VOUT, VCC, GND, GND2, GND3	6	Vector Electronic	K24C/M	.042 Dia	Test Point Post
33	UVIN, SS	2	Mill-Max	3137-3002-10-0080	.042 Dia	Test Point Female Pin

ORDERING INFORMATION

Model	Temperature Range	Package Type
SP6132EB.....	0°C to +70°C.....	SP6132 Evaluation Board
SP6132CU.....	0°C to +70°C.....	10-pin MSOP