

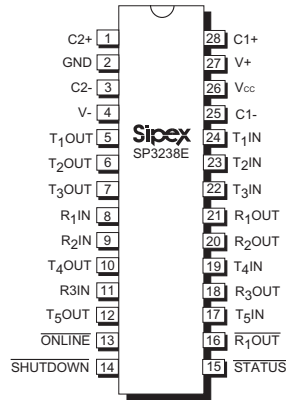

Intelligent +3.0V to +5.5V RS-232 Transceiver

- Meets true EIA/TIA-232-F Standards from a +3.0V to +5.5V power supply
- Interoperable with EIA/TIA-232 and adheres to EIA/TIA-562 down to a +2.7V power source
- **AUTO ON-LINE®** circuitry automatically wakes up from a 1µA shutdown
- Minimum 250Kbps data rate under load
- Regulated Charge Pump Yields Stable RS-232 Outputs Regardless of V_{CC} Variations
- Enhanced ESD Specifications:
 - +15KV Human Body Model
 - +15KV IEC1000-4-2 Air Discharge
 - +8KV IEC1000-4-2 Contact Discharge



Now Available in Lead Free Packaging

DESCRIPTION

The SP3238E device is an RS-232 transceiver solution intended for portable or hand-held applications such as notebook and palmtop computers. The SP3238E uses an internal high-efficiency, charge-pump power supply that requires only 0.1µF capacitors in 3.3V operation. This charge pump and Sipex's driver architecture allow the SP3238E device to deliver compliant RS-232 performance from a single power supply ranging from +3.0V to +5.0V. The SP3238E is a 5-driver/3-receiver device, ideal for laptop/notebook computer and PDA applications. The SP3238E includes one complementary receiver that remains alert to monitor an external device's Ring Indicate signal while the device is shutdown.

The **AUTO ON-LINE®** feature allows the device to automatically "wake-up" during a shutdown state when an RS-232 cable is connected and a connected peripheral is turned on. Otherwise, the device automatically shuts itself down drawing less than 1µA.

SELECTION TABLE

| Device | Power Supplies | RS-232 Drivers | RS-232 Receivers | External Components | AUTO ON-LINE® Circuitry | TTL 3-State | No. of Pins |
|---------|----------------|----------------|------------------|---------------------|-------------------------|-------------|-------------|
| SP3220E | +3.0V to +5.5V | 1 | 1 | 4 capacitors | NO | YES | 16 |
| SP3223E | +3.0V to +5.5V | 2 | 2 | 4 capacitors | YES | YES | 20 |
| SP3243E | +3.0V to +5.5V | 3 | 5 | 4 capacitors | YES | YES | 28 |
| SP3238E | +3.0V to +5.5V | 5 | 3 | 4 capacitors | YES | YES | 28 |

Applicable U.S. Patents - 5,306,954; and other patents pending.

ABSOLUTE MAXIMUM RATINGS

These are stress ratings only and functional operation of the device at these ratings or any other above those indicated in the operation sections of the specifications below is not implied. Exposure to absolute maximum rating conditions for extended periods of time may affect reliability and cause permanent damage to the device.

- V_{CC}.....-0.3V to +6.0V
- V+ (NOTE 1).....-0.3V to +7.0V
- V- (NOTE 1).....+0.3V to -7.0V
- V+ + |V-| (NOTE 1).....+13V
- I_{CC} (DC V_{CC} or GND current).....±100mA

Input Voltages

- TxIN, ONLINE, SHUTDOWN,-0.3V to +V_{CC} + 0.3V
- RxIN.....±25V

Output Voltages

- TxOUT.....±13.2V
- RxOUT, STATUS.....-0.3V to (V_{CC} + 0.3V)

Short-Circuit Duration

- TxOUT.....Continuous
- Storage Temperature.....-65°C to +150°C

Power Dissipation per package

- 28-pin SSOP (derate 11.2mW/°C above +70°C).....900mW
- 28-pin TSSOP (derate 13.2mW/°C above +70°C).....1100mW

Note 1: V+ and V- can have maximum magnitudes of 7V, but their absolute difference cannot exceed 13V.

ELECTRICAL CHARACTERISTICS

V_{CC} = +3.0 to +5.5, C1 -C4 = 0.1µF (tested at 3.3V ± 5%), C1-C4 = 0.22µF (tested at 3.3V ± 10%), C1 = 0.047µF, and C2-C4 = 0.33µF (tested at 5.0V ± 10%), T_A = T_{MIN} to T_{MAX}, unless otherwise noted. Typical values are at T_A = +25°C.)

| PARAMETER | MIN. | TYP. | MAX. | UNITS | CONDITIONS |
|--|-----------------------|-----------------------|------|-------|---|
| DC CHARACTERISTICS | | | | | |
| Supply Current, AUTO ON-LINE® | | 1.0 | 10 | µA | All RxIN open, ONLINE = GND, SHUTDOWN = V _{CC} , all TxIN=GND or V _{CC} |
| Supply Current, Shutdown | | 1.0 | 10 | µA | SHUTDOWN=GND, all TxIN=GND or V _{CC} |
| Supply Current, AUTO ON-LINE® Disabled | | 0.3 | 1.0 | mA | ONLINE = SHUTDOWN = V _{CC} , no load, all TxIN=GND or V _{CC} |
| LOGIC INPUTS AND RECEIVER OUTPUTS | | | | | |
| Input Logic Threshold LOW HIGH | | | 0.8 | V | V _{CC} = +3.3V or +5.0V, TxIN ONLINE, SHUTDOWN |
| Input Leakage Current | | ±0.01 | ±1.0 | µA | TxIN, ONLINE, SHUTDOWN T _A = 25° C |
| Output Leakage Current | | ±0.05 | ±10 | µA | Receivers Disabled |
| Output Voltage LOW | | | 0.4 | V | I _{OUT} = 1.6mA |
| Output Voltage HIGH | V _{CC} - 0.6 | V _{CC} - 0.1 | | V | I _{OUT} = -1.0mA |

$V_{CC} = +3.0$ to $+5.5$, C1-C4 = $0.1\mu F$ (tested at $3.3V \pm 5\%$), C1-C4 = $0.22\mu F$ (tested at $3.3V \pm 10\%$), C1 = $0.047\mu F$, and C2-C4 = $0.33\mu F$ (tested at $5.0V \pm 10\%$), $T_A = T_{MIN}$ to T_{MAX} , unless otherwise noted. Typical values are at $T_A = +25^\circ C$.

| PARAMETER | MIN. | TYP. | MAX. | UNITS | CONDITIONS |
|--|----------------|-----------|----------|-----------|--|
| DRIVER OUTPUTS | | | | | |
| Output Voltage Swing | ± 5.0 | ± 5.4 | | V | All driver outputs loaded with $3K\Omega$ to GND |
| Output Resistance | 300 | | | Ω | $V_{CC} = V+ = V- = 0V$, $V_{OUT} = \pm 2V$ |
| Output Short-Circuit Current | | ± 35 | ± 60 | mA | $V_{OUT} = GND$ |
| RECEIVER INPUTS | | | | | |
| Input Voltage Range | -25 | | 25 | V | |
| Input Threshold LOW | 0.6 | 1.2 | | V | $V_{CC} = 3.3V$ |
| Input Threshold LOW | 0.8 | 1.5 | | V | $V_{CC} = 5.0V$ |
| Input Threshold HIGH | | 1.5 | 2.4 | V | $V_{CC} = 3.3V$ |
| Input Threshold HIGH | | 1.8 | 2.4 | V | $V_{CC} = 5.0V$ |
| Input Hysteresis | | 0.5 | | V | |
| Input Resistance | 3 | 5 | 7 | $k\Omega$ | |
| AUTO ON-LINE[®] CIRCUITRY CHARACTERISTICS (ONLINE = GND, SHUTDOWN = V_{CC}) | | | | | |
| STATUS Output Voltage LOW | | | 0.4 | V | $I_{OUT} = 1.6mA$ |
| STATUS Output Voltage HIGH | $V_{CC} - 0.6$ | | | V | $I_{OUT} = -1.0mA$ |
| Receiver Threshold to Drivers Enabled (t_{ONLINE}) | | 200 | | μS | Figure 10 |
| Receiver Positive or Negative Threshold to STATUS HIGH (t_{STSH}) | | 0.5 | | μS | Figure 10 |
| Receiver Positive or Negative Threshold to STATUS LOW (t_{STSL}) | | 20 | | μS | Figure 10 |

$V_{CC} = +3.0$ to $+5.5$, C1-C4 = $0.1\mu F$ (tested at $3.3V \pm 5\%$), C1-C4 = $0.22\mu F$ (tested at $3.3V \pm 10\%$), C1 = $0.047\mu F$, and C2-C4 = $0.33\mu F$ (tested at $5.0V \pm 10\%$), $T_A = T_{MIN}$ to T_{MAX} , unless otherwise noted. Typical values are at $T_A = +25^\circ C$.

| PARAMETER | MIN. | TYP. | MAX. | UNITS | CONDITIONS |
|--|------|--------------|------|------------|--|
| TIMING CHARACTERISTICS | | | | | |
| Maximum Data Rate | 250 | | | kbps | $R_L = 3k\Omega$, $C_L = 1000pF$, one driver switching |
| Receiver Propagation Delay t_{PHL} t_{PLH} | | 0.15 0.15 | | μS | Receiver input to receiver output, $C_L = 150pF$ |
| Receiver Output Enable Time | | 200 | | ns | Normal operation |
| Receiver Output Disable Time | | 200 | | ns | Normal operation |
| Driver Skew | | 100 | | ns | $ t_{PLH} - t_{PHL} $, $T_A = 25^\circ C$ |
| Receiver Skew | | 50 | | ns | $ t_{PLH} - t_{PHL} $ |
| Transition-Region Slew Rate | | | 30 | V/ μs | $V_{CC} = 3.3V$, $R_L = 3k\Omega$, $T_{AMB} = 25^\circ C$, measurements taken from $-3.0V$ to $+3.0V$ or $+3.0V$ to $-3.0V$ |

TYPICAL PERFORMANCE CHARACTERISTICS

Unless otherwise noted, the following performance characteristics apply for $V_{CC} = +3.3V$, 250kbps data rate, all drivers loaded with $3k\Omega$, $0.1\mu F$ charge pump capacitors, and $T_{AMB} = +25^\circ C$.

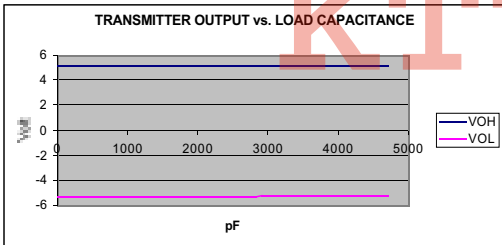

Figure 1.

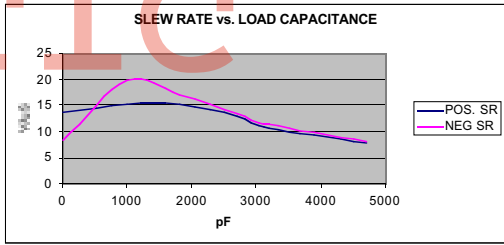

Figure 2.

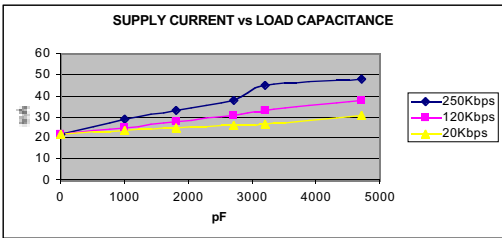

Figure 3. Supply Current VS. Load Capacitance when Transmitting Data

| PIN DESCRIPTION | | |
|-----------------------------------|---|---------|
| NAME | FUNCTION | PIN NO. |
| C2+ | Positive terminal of the symmetrical charge-pump capacitor C2. | 1 |
| GND | Ground. | 2 |
| C2- | Negative terminal of the symmetrical charge-pump capacitor C2. | 3 |
| V- | Regulated -5.5V output generated by the charge pump. | 4 |
| T ₁ OUT | RS-232 driver output. | 5 |
| T ₂ OUT | RS-232 driver output. | 6 |
| T ₃ OUT | RS-232 driver output. | 7 |
| R ₁ IN | RS-232 receiver input. | 8 |
| R ₂ IN | RS-232 receiver input. | 9 |
| T ₄ OUT | RS-232 driver output. | 10 |
| R ₃ IN | RS-232 receiver input. | 11 |
| T ₅ OUT | RS-232 driver output. | 12 |
| $\overline{\text{ONLINE}}$ | Apply logic HIGH to override AUTO ON-LINE [®] circuitry keeping drivers active (SHUTDOWN must also be logic HIGH, refer to Table 2). | 13 |
| $\overline{\text{SHUTDOWN}}$ | Apply logic LOW to shut down drivers and charge pump. This overrides all AUTO ON-LINE [®] circuitry and ONLINE (refer to Table 2). | 14 |
| $\overline{\text{STATUS}}$ | TTL/CMOS Output indicating if a RS-232 signal is present on any receiver input. | 15 |
| $\overline{\text{R}}_1\text{OUT}$ | Non-inverting receiver-1 output, active in shutdown. | 16 |
| T ₅ IN | TTL/CMOS driver input. | 17 |
| R ₃ OUT | TTL/CMOS receiver output. | 18 |
| T ₄ IN | TTL/CMOS driver input. | 19 |
| R ₂ OUT | TTL/CMOS receiver output. | 20 |
| R ₁ OUT | TTL/CMOS receiver output. | 21 |
| T ₃ IN | TTL/CMOS driver input. | 22 |
| T ₂ IN | TTL/CMOS driver input. | 23 |
| T ₁ IN | TTL/CMOS driver input. | 24 |
| C1- | Negative terminal of the symmetrical charge-pump capacitor C1. | 25 |
| V _{CC} | +3.0V to +5.5V supply voltage. | 26 |
| V+ | Regulated +5.5V output generated by the charge pump. | 27 |
| C1+ | Positive terminal of the symmetrical charge-pump capacitor C1 | 28 |

Table 1. Device Pin Description

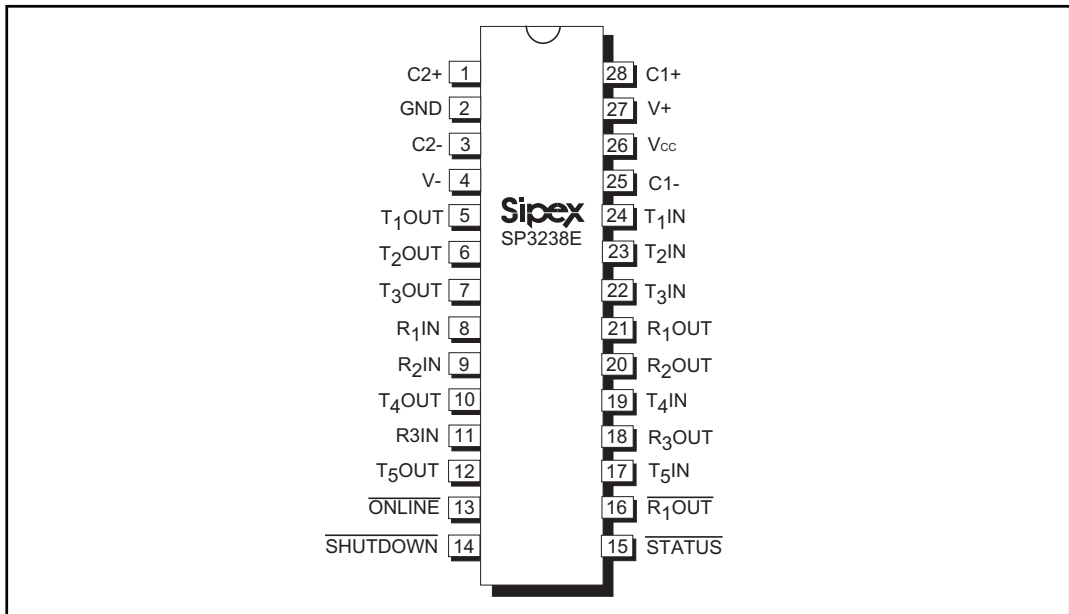

Figure 4. SP3238E Pinout Configuration

KTTIC

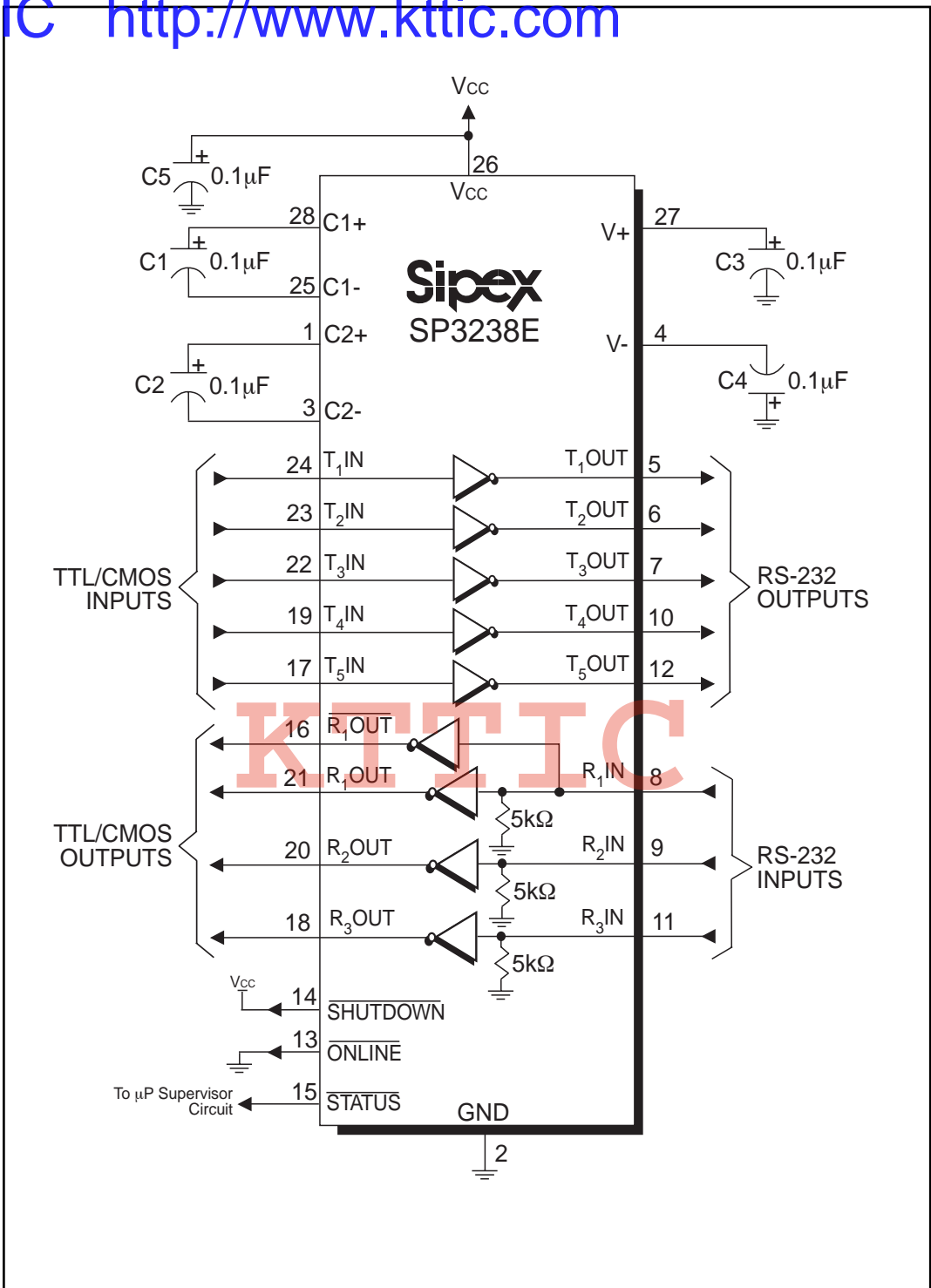

Figure 5. SP3238E Typical Operating Circuit

DESCRIPTION

The SP3238E device meets the EIA/TIA-232 and ITU-T V.28/V.24 communication protocols and can be implemented in battery-powered, portable, or hand-held applications such as notebook or palmtop computers. The SP3238E device features Sipex's proprietary and patented (U.S. #5,306,954) on-board charge pump circuitry that generates $\pm 5.5V$ RS-232 voltage levels from a single +3.0V to +5.5V power supply. The SP3238E device can guarantee a data rate of 250kbps fully loaded.

The SP3238E is a 5-driver/3-receiver device, ideal for portable or hand-held applications. The SP3238E includes one complementary always-active receiver that can monitor an external device (such as a modem) in shutdown. This aids in protecting the UART or serial controller IC by preventing forward biasing of the protection diodes where V_{CC} may be disconnected.

The SP3238E device is an ideal choice for power sensitive designs. The SP3238E device features **AUTO ON-LINE**[®] circuitry which reduces the power supply drain to a 1 μA supply current. In many portable or hand-held applications, an RS-232 cable can be disconnected or a connected peripheral can be turned off. Under these conditions, the internal charge pump and the drivers will be shut down. Otherwise, the system automatically comes online. This feature allows design engineers to address power saving concerns without major design changes.

THEORY OF OPERATION

The SP3238E device is made up of four basic circuit blocks: 1. Drivers, 2. Receivers, 3. the Sipex proprietary charge pump, and 4. **AUTO ON-LINE**[®] circuitry.

Drivers

The drivers are inverting level transmitters that convert TTL or CMOS logic levels to 5.0V EIA/TIA-232 levels with an inverted sense relative to the input logic levels. Typically, the RS-232 output voltage swing is $\pm 5.4V$ with no load and $\pm 5V$ minimum fully loaded. The driver outputs are protected against infinite short-circuits to ground without degradation in reliability. These drivers comply with the EIA-TIA-232F and all previous RS-232 versions.

The drivers can guarantee a data rate of 250kbps fully loaded with 3k Ω in parallel with 1000pF, ensuring compatibility with PC-to-PC communication software. All unused driver inputs must be connected to V_{CC} or GND.

The slew rate of the driver output is internally limited to a maximum of 30V/ μs in order to meet the EIA standards (EIA RS-232D 2.1.7, Paragraph 5). The transition of the loaded output from HIGH to LOW also meets the monotonicity requirements of the standard.

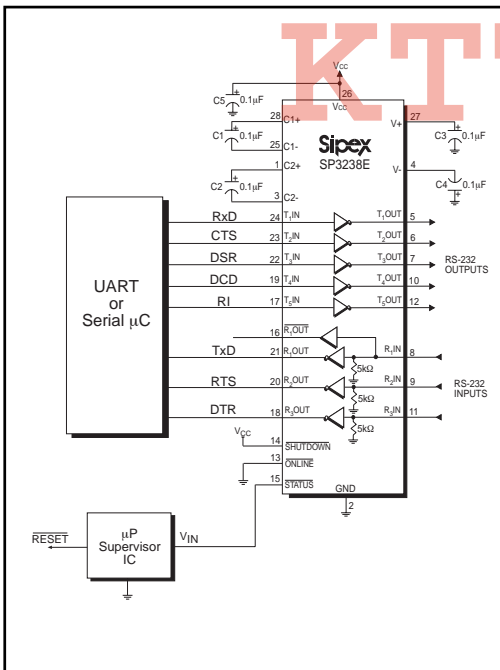

Figure 6. Interface Circuitry Controlled by Microprocessor Supervisory Circuit

Figure 7 shows a loopback test circuit used to test the RS-232 Drivers. Figure 8 shows the test results of the loopback circuit with all five drivers active at 120kbps with typical RS-232 loads in parallel with 1000pF capacitors. Figure 6 shows the test results where one driver was active at 250kbps and all five drivers loaded with an RS-232 receiver in parallel with a 1000pF capacitor. A solid RS-232 data transmission rate of 120kbps provides compatibility with many designs in personal computer peripherals and LAN applications.

Receivers

The receivers convert $\pm 5.0V$ EIA/TIA-232 levels to TTL or CMOS logic output levels.

Receivers are not active when in shutdown. If there is no activity present at the receivers for a period longer than $100\mu s$ during AUTO ON-LINE[®] mode or when SHUTDOWN is enabled, the device goes into a standby mode where the circuit draws $1\mu A$.

The truth table logic of the driver and receiver outputs can be found in Table 2.

The SP3238E includes an additional non-inverting receiver with an output R_1OUT . R_1OUT is an extra output that remains active and monitors activity while the other receiver outputs are forced into high impedance. This allows Ring

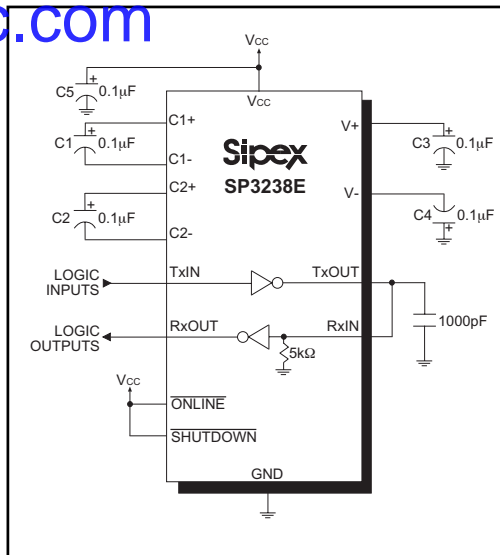

Figure 7. Loopback Test Circuit for RS-232 Driver Data Transmission Rates

Indicator (RI) from a peripheral to be monitored without forward biasing the TTL/CMOS inputs of the other devices connected to the receiver outputs.

Since receiver input is usually from a transmission line where long cable lengths and system interference can degrade the signal, the inputs have a typical hysteresis margin of 300mV. This ensures that the receiver is virtually immune to

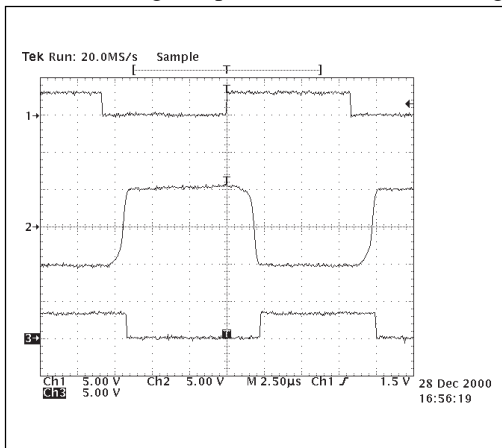

Figure 8. Loopback Test Circuit Result at 120kbps (All Drivers Fully Loaded)

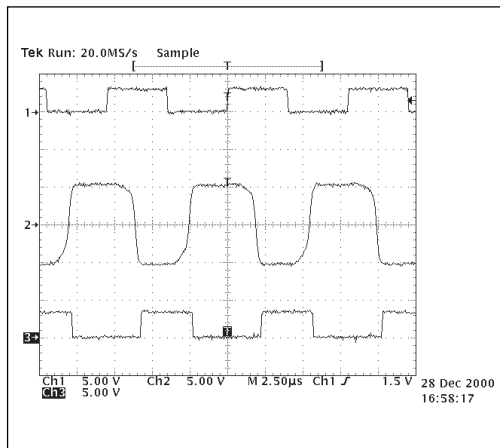

Figure 9. Loopback Test Circuit result at 250kbps (All Drivers Fully Loaded)

noisy transmission lines. Should an input be left unconnected, an internal 5k Ω pulldown resistor to ground will commit the output of the receiver to a HIGH state.

Charge Pump

The charge pump is a Sipex-patented design (U.S. #5,306,954) and uses a unique approach compared to older less-efficient designs. The charge pump still requires four external capacitors, but uses a four-phase voltage shifting technique to attain symmetrical 5.5V power supplies. The internal power supply consists of a regulated dual charge pump that provides output voltages 5.5V regardless of the input voltage (V_{CC}) over the +3.0V to +5.5V range. This is important to maintain compliant RS-232 levels regardless of power supply fluctuations.

The charge pump operates in a discontinuous mode using an internal oscillator. If the output voltages are less than a magnitude of 5.5V, the charge pump is enabled. If the output voltages exceed a magnitude of 5.5V, the charge pump is disabled. This oscillator controls the four phases of the voltage shifting (Figure 13). A description of each phase follows.

Phase 1 (Figure 11)

— V_{SS} charge storage — During this phase of the clock cycle, the positive side of capacitors C_1 and C_2 are initially charged to V_{CC} . C_{1+} is then switched to GND and the charge in C_{1-} is transferred to C_{2-} . Since C_{2+} is connected to V_{CC} , the voltage potential across capacitor C_2 is now 2 times V_{CC} .

Phase 2 (Figure 12)

— V_{SS} transfer — Phase two of the clock connects the negative terminal of C_2 to the V_{SS} storage capacitor and the positive terminal of C_2 to GND. This transfers a negative generated voltage to C_3 . This generated voltage is regulated to a minimum voltage of -5.5V. Simultaneous with the transfer of the voltage to C_3 , the positive side of capacitor C_1 is switched to V_{CC} and the negative side is connected to GND.

Phase 3 (Figure 14)

— V_{DD} charge storage — The third phase of the clock is identical to the first phase — the charge transferred in C_1 produces $-V_{CC}$ in the negative terminal of C_1 , which is applied to the negative side of capacitor C_2 . Since C_{2+} is at V_{CC} , the voltage potential across C_2 is 2 times V_{CC} .

Phase 4 (Figure 15)

— V_{DD} transfer — The fourth phase of the clock connects the negative terminal of C_2 to GND, and transfers this positive generated voltage across C_2 to C_4 , the V_{DD} storage capacitor. This voltage is regulated to +5.5V. At this voltage, the internal oscillator is disabled. Simultaneous with the transfer of the voltage to C_4 , the positive side of capacitor C_1 is switched to V_{CC} and the negative side is connected to GND, allowing the charge pump cycle to begin again. The charge pump cycle will continue as long as the operational conditions for the internal oscillator are present.

Since both V^+ and V^- are separately generated from V_{CC} , in a no-load condition V^+ and V^- will be symmetrical. Older charge pump approaches that generate V^- from V^+ will show a decrease in the magnitude of V^- compared to V^+ due to the inherent inefficiencies in the design.

The clock rate for the charge pump typically operates at 500kHz. The external capacitors can be as low as 0.1 μ F with a 16V breakdown voltage rating.

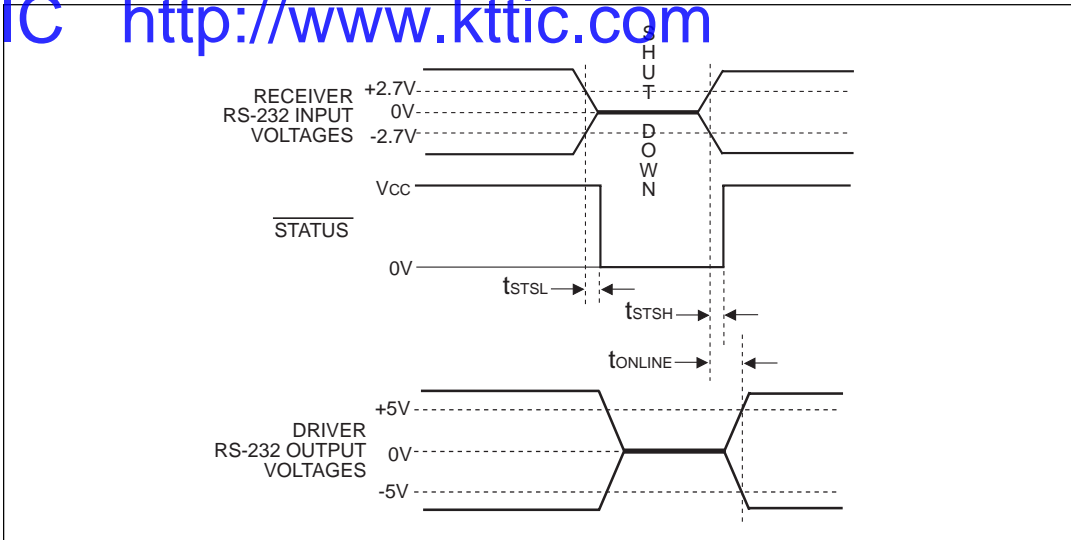

Figure 10. AUTO ON-LINE® Timing Waveforms

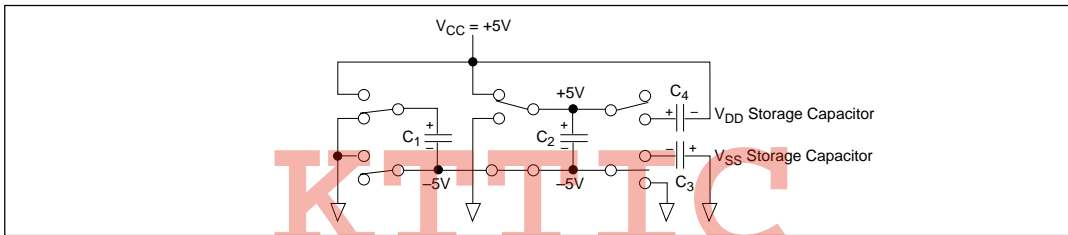

Figure 11. Charge Pump — Phase 1

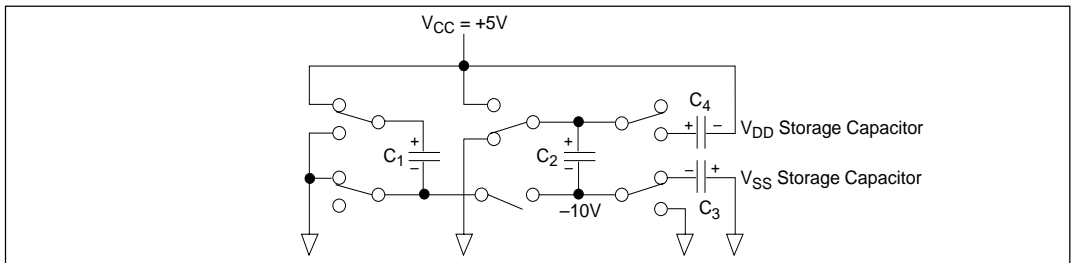

Figure 12. Charge Pump — Phase 2

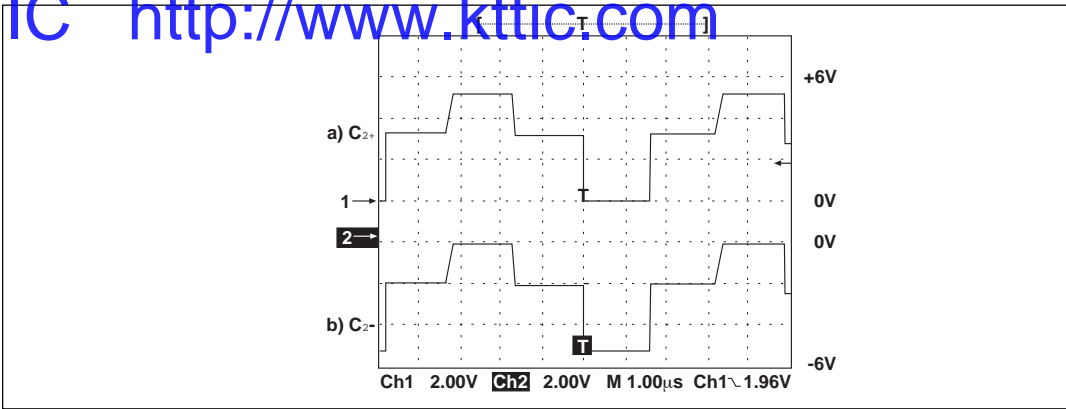

Figure 13. Charge Pump Waveforms

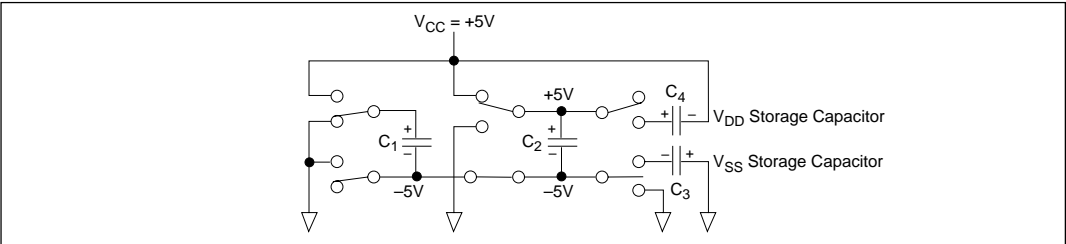

Figure 14. Charge Pump — Phase 3

KTTIC

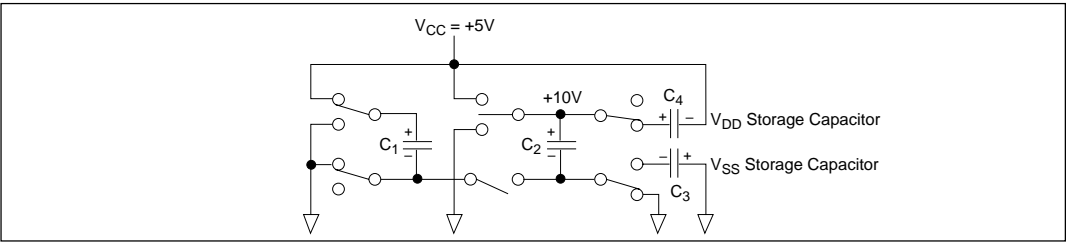

Figure 15. Charge Pump — Phase 4

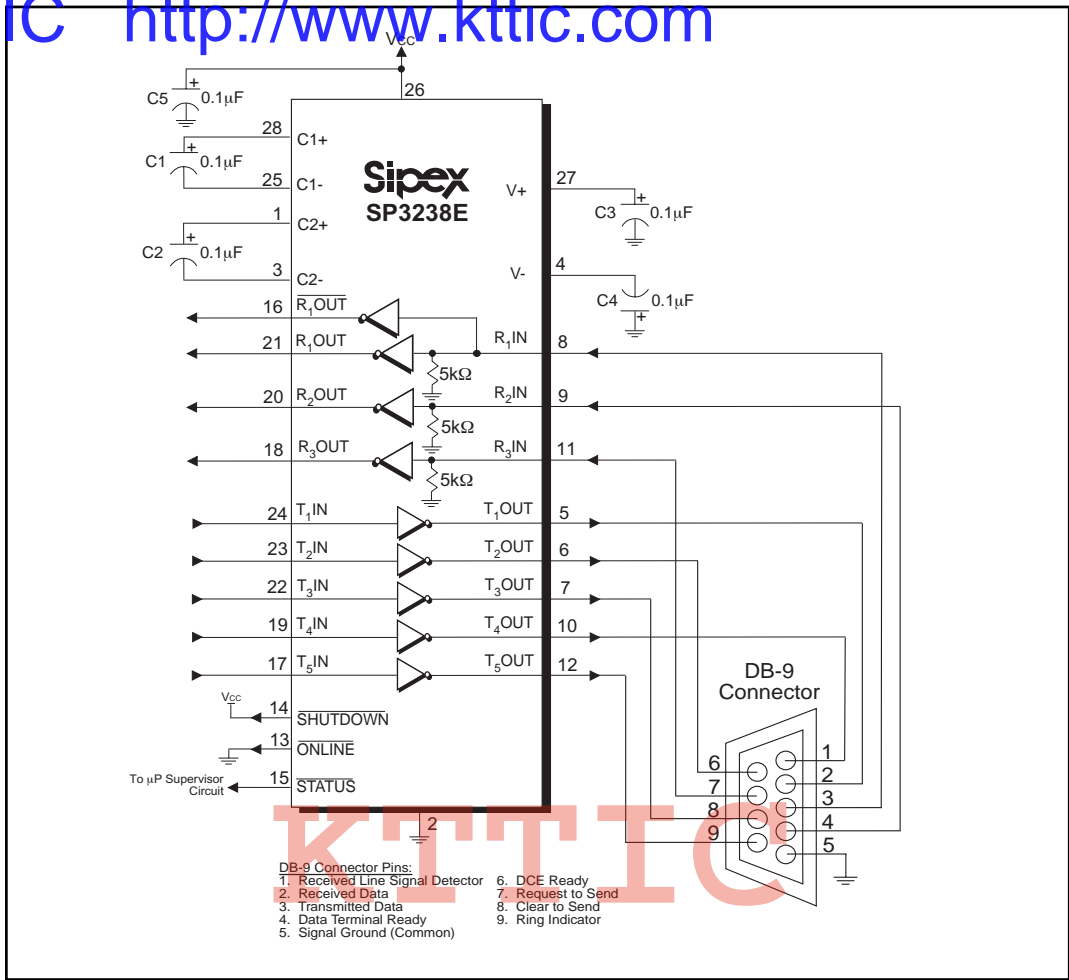

Figure 16. Circuit for the connectivity of the SP3238E with a DB-9 connector

| SHUTDOWN INPUT | ON-LINE INPUT | RS-232 SIGNAL AT RECEIVER INPUT | STATUS OUTPUT | T _x OUT | R _x OUT | R _i OUT | TRANSCEVER STATUS |
|----------------|---------------|---------------------------------|---------------|--------------------|--------------------|--------------------|--|
| HIGH | - | YES | HIGH | Active | Active | Active | Normal Operation |
| HIGH | HIGH | NO | LOW | Active | Active | Active | Normal Operation |
| HIGH | LOW | NO (>100μs) | LOW | High-Z | Active | Active | Shutdown (<i>AUTO ON-LINE</i> [®]) |
| LOW | - | YES | HIGH | High-Z | High-Z | Active | Shutdown |
| LOW | - | NO | LOW | High-Z | High-Z | Active | Shutdown |

Table 2. *AUTO ON-LINE*[®] Logic

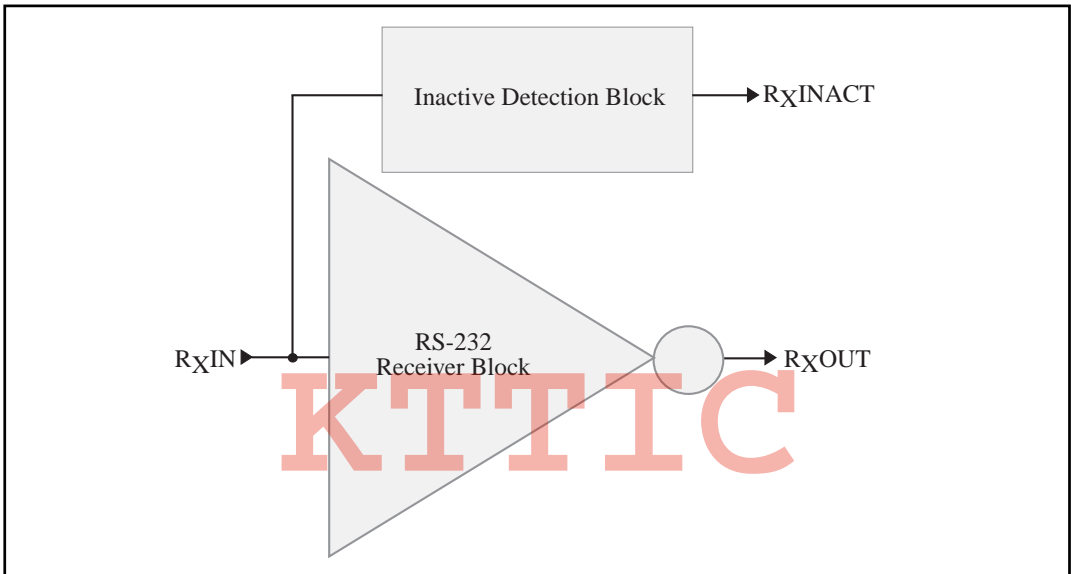

Figure 17. Stage I of *AUTO ON-LINE*[®] Circuitry

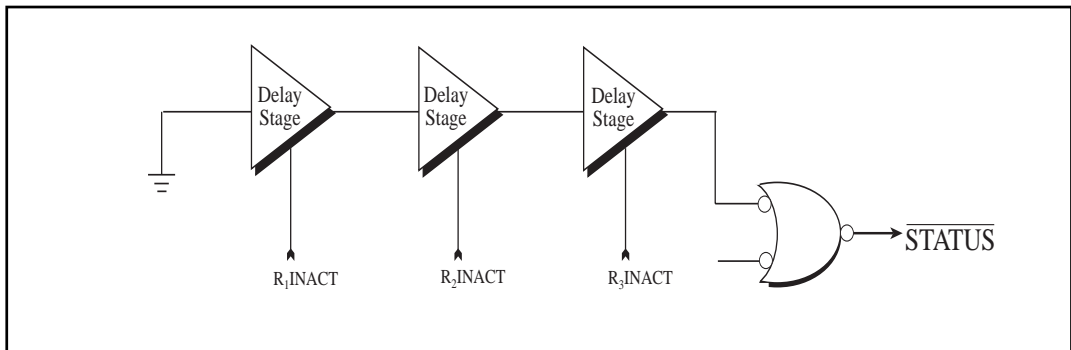

Figure 18. Stage II of *AUTO ON-LINE*[®] Circuitry

The SP3238E device has a patent pending **AUTO ON-LINE**[®] circuitry on board that saves power in applications such as laptop computers, palmtop (PDA) computers, and other portable systems.

The SP3238E device incorporates an **AUTO ON-LINE**[®] circuit that automatically enables itself when the external transmitters are enabled and the cable is connected. Conversely, the **AUTO ON-LINE**[®] circuit also disables most of the internal circuitry when the device is not being used and goes into a standby mode where the device typically draws 1 μ A. This function is externally controlled by the ONLINE pin. When this pin is tied to a logic LOW, the **AUTO ON-LINE**[®] function is active. Once active, the device is enabled until there is no activity on the receiver inputs. The receiver input typically sees at least $\pm 3V$, which are generated from the transmitters at the other end of the cable with a $\pm 5V$ minimum. When the external transmitters are disabled or the cable is disconnected, the receiver inputs will be pulled down by their internal 5k Ω resistors to ground. When this occurs over a period of time, the internal transmitters will be disabled and the device goes into a shutdown or standby mode. When ONLINE is HIGH, the **AUTO ON-LINE**[®] mode is disabled.

The **AUTO ON-LINE**[®] circuit has two stages:

- 1) Inactive Detection
- 2) Accumulated Delay

The first stage, shown in Figure 17, detects an inactive input. A logic HIGH is asserted on R_XINACT if the cable is disconnected or the external transmitters are disabled. Otherwise, R_XINACT will be at a logic LOW. This circuit is duplicated for each of the other receivers.

The second stage of the **AUTO ON-LINE**[®] circuitry, shown in Figure 18, processes all the receiver's R_XINACT signals with an accumulated delay that disables the device to a 1 μ A supply current.

The STATUS pin goes to a logic LOW when the cable is disconnected or when the external transmitters are disabled.

When the drivers or internal charge pump are disabled, the supply current is reduced to 1 μ A. This can commonly occur in hand-held or portable applications where the RS-232 cable is disconnected or the RS-232 drivers of the connected peripheral are turned off.

The **AUTO ON-LINE**[®] mode can be disabled by the SHUTDOWN pin. If this pin is a logic LOW, the **AUTO ON-LINE**[®] function will not operate regardless of the logic state of the ONLINE pin. Table 2 summarizes the logic of the **AUTO ON-LINE**[®] operating modes and the truth table logic of the driver and receiver outputs.

The STATUS pin outputs a logic LOW signal when there is no valid RS-232 signal present on any receiver input. This pin goes to a logic HIGH when the external transmitters are enabled and the cable is connected.

When the SP3238E device is shut down, the charge pump is turned off. V+ charge pump output decays to V_{CC}, the V- output decays to GND. The decay time will depend on the size of capacitors used for the charge pump. Once in shutdown, the time required to exit the shutdown state and have valid V+ and V- levels is typically 200ms.

For easy programming, the STATUS pin can be used to indicate DTR or a Ring Indicator signal. Tying ONLINE and SHUTDOWN together will bypass the **AUTO ON-LINE**[®] circuitry so this connection acts like a shutdown input pin.

ESD TOLERANCE

The SP3238E device incorporates ruggedized ESD cells on all driver output and receiver input pins. The ESD structure is improved over our previous family for more rugged applications and environments sensitive to electro-static discharges and associated transients. The improved ESD tolerance is at least $\pm 15\text{kV}$ without damage nor latch-up.

There are different methods of ESD testing applied:

- a) MIL-STD-883, Method 3015.7
- b) IEC1000-4-2 Air-Discharge
- c) IEC1000-4-2 Direct Contact

The Human Body Model has been the generally accepted ESD testing method for semiconductors. This method is also specified in MIL-STD-883, Method 3015.7 for ESD testing. The premise of this ESD test is to simulate the human body's potential to store electro-static energy and discharge it to an integrated circuit. The simulation is performed by using a test model as shown in Figure 19. This method will test the IC's capability to withstand an ESD transient during normal handling such as in manufacturing areas where the ICs tend to be handled frequently.

The IEC-1000-4-2, formerly IEC801-2, is generally used for testing ESD on equipment and systems. For system manufacturers, they must guarantee a certain amount of ESD protection since the system itself is exposed to the outside environment and human presence. The premise with IEC1000-4-2 is that the system is required to withstand an amount of static electricity when ESD is applied to points and surfaces of the equipment that are accessible to personnel during

normal usage. The transceiver IC receives most of the ESD current when the ESD source is applied to the connector pins. The test circuit for IEC1000-4-2 is shown on Figure 20. There are two methods within IEC1000-4-2, the Air Discharge method and the Contact Discharge method.

With the Air Discharge Method, an ESD voltage is applied to the equipment under test (EUT) through air. This simulates an electrically charged person ready to connect a cable onto the rear of the system only to find an unpleasant zap just before the person touches the back panel. The high energy potential on the person discharges through an arcing path to the rear panel of the system before he or she even touches the system. This energy, whether discharged directly or through air, is predominantly a function of the discharge current rather than the discharge voltage. Variables with an air discharge such as approach speed of the object carrying the ESD potential to the system and humidity will tend to change the discharge current. For example, the rise time of the discharge current varies with the approach speed.

The Contact Discharge Method applies the ESD current directly to the EUT. This method was devised to reduce the unpredictability of the ESD arc. The discharge current rise time is constant since the energy is directly transferred without the air-gap arc. In situations such as hand held systems, the ESD charge can be directly discharged to the equipment from a person already holding the equipment. The current is transferred on to the keypad or the serial port of the equipment directly and then travels through the PCB and finally to the IC.

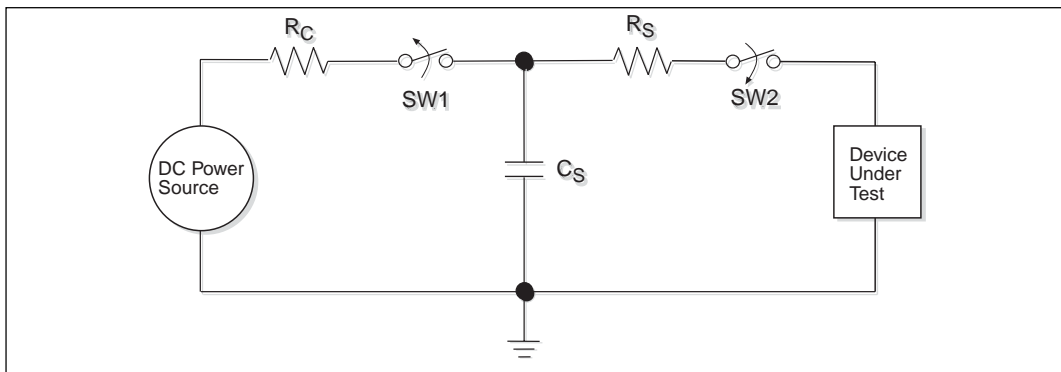

Figure 19. ESD Test Circuit for Human Body Model

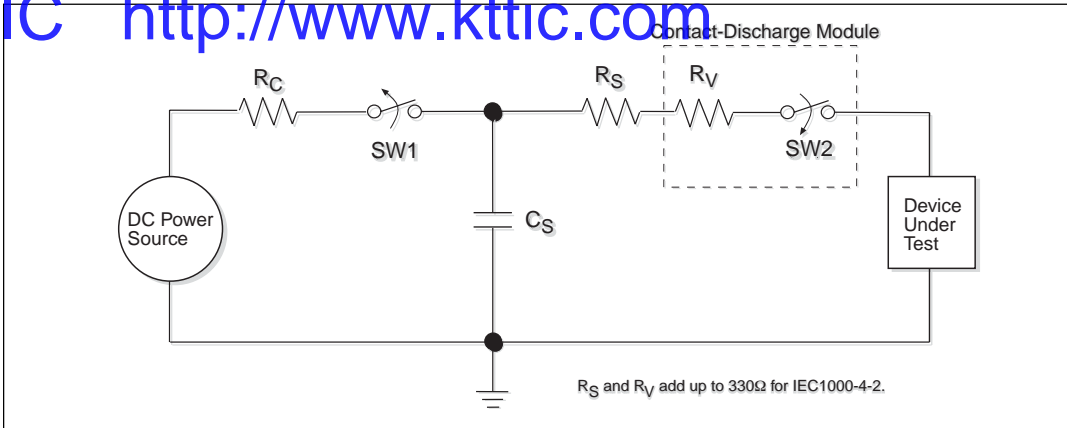

Figure 20. ESD Test Circuit for IEC1000-4-2

The circuit model in Figures 19 and 20 represent the typical ESD testing circuit used for all three methods. The C_S is initially charged with the DC power supply when the first switch (SW1) is on. Now that the capacitor is charged, the second switch (SW2) is on while SW1 switches off. The voltage stored in the capacitor is then applied through R_S , the current limiting resistor, onto the device under test (DUT). In ESD tests, the SW2 switch is pulsed so that the device under test receives a duration of voltage.

For the Human Body Model, the current limiting resistor (R_S) and the source capacitor (C_S) are 1.5kΩ and 100pF, respectively. For IEC-1000-4-2, the current limiting resistor (R_S) and the source capacitor (C_S) are 330Ω and 150pF, respectively.

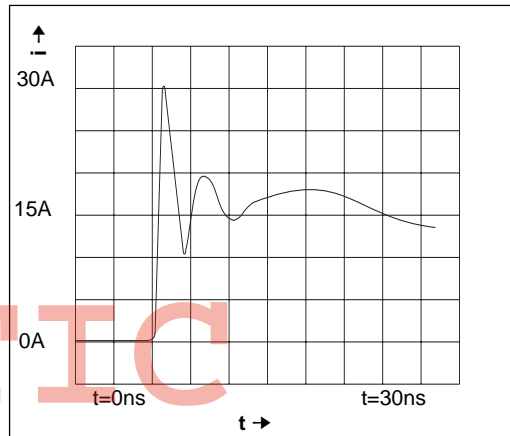
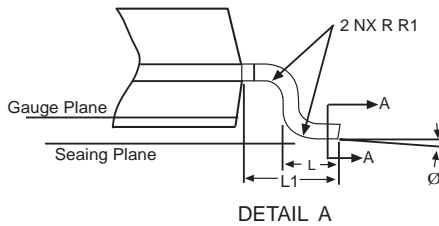
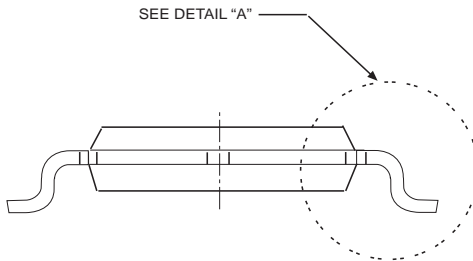
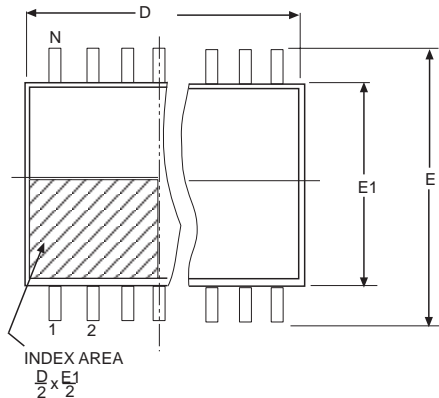

Figure 21. ESD Test Waveform for IEC1000-4-2

The higher C_S value and lower R_S value in the IEC1000-4-2 model are more stringent than the Human Body Model. The larger storage capacitor injects a higher voltage to the test point when SW2 is switched on. The lower current limiting resistor increases the current charge onto the test point.

| DEVICE PIN TESTED | HUMAN BODY MODEL | IEC1000-4-2 | | |
|-------------------|------------------|---------------|----------------|-------|
| | | Air Discharge | Direct Contact | Level |
| Driver Outputs | ±15kV | ±15kV | ±8kV | 4 |
| Receiver Inputs | ±15kV | ±15kV | ±8kV | 4 |

Table 3. Transceiver ESD Tolerance Levels



| 28 Pin SSOP JEDEC MO-150 (AH) Variation | | | |
|---|----------|------|------|
| SYMBOL | MIN | NOM | MAX |
| A | - | - | 2 |
| A1 | 0.05 | - | - |
| A2 | 1.65 | 1.75 | 1.85 |
| b | 0.22 | - | 0.38 |
| c | 0.09 | - | 0.25 |
| D | 9.9 | 10.2 | 10.5 |
| E | 7.4 | 7.8 | 8.2 |
| E1 | 5 | 5.3 | 5.6 |
| L | 0.55 | 0.75 | 0.95 |
| L1 | 1.25 REF | | |
| Ø | 0° | 4° | 8° |

Note: Dimensions in (mm)

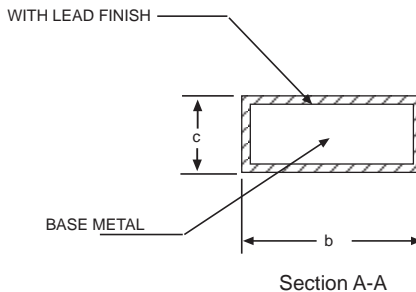
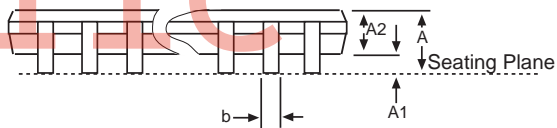

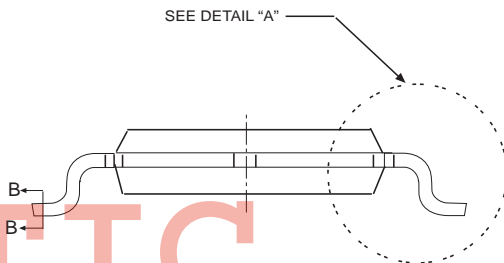
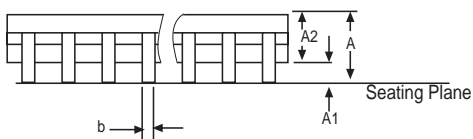
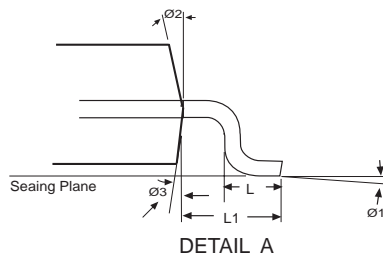
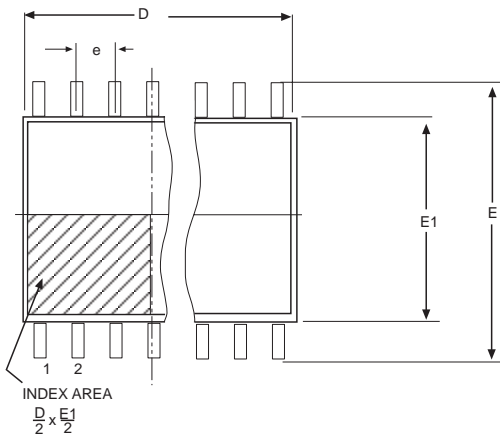

KTTIC

| 28 Pin TSSOP JEDEC MO-153 (AE) Variation | | | |
|---|----------|-----|------|
| SYMBOL | MIN | NOM | MAX |
| A | - | - | 1.2 |
| A1 | 0.05 | - | 0.15 |
| A2 | 0.8 | 1 | 1.05 |
| b | 0.19 | - | 0.3 |
| c | 0.09 | - | 0.2 |
| D | 9.6 | 9.7 | 9.8 |
| e | 0.65 BSC | | |
| E | 6.40 BSC | | |
| E1 | 4.3 | 4.4 | 4.5 |
| L | 0.45 | 0.6 | 0.75 |
| L1 | 1.00 REF | | |
| Ø1 | 0° | - | 8° |
| Ø2 | 12° REF | | |
| Ø3 | 12° REF | | |

Note: Dimensions in (mm)

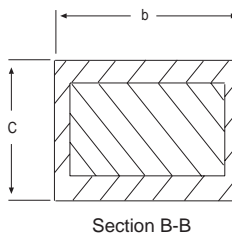

ORDERING INFORMATION

| Model | Temperature Range | Package Types |
|------------------------|--------------------------|---------------|
| SP3238ECA | 0°C to +70°C | .28-pin SSOP |
| SP3238ECA/TR | 0°C to +70°C | 28-pin SSOP |
| SP3238ECY | 0°C to +70°C | 28-pin TSSOP |
| SP3238ECY/TR | 0°C to +70°C | 28-pin TSSOP |
| SP3238EEA | -40°C to +85°C | 28-pin SSOP |
| SP3238EEA/TR | -40°C to +85°C | 28-pin SSOP |
| SP3238EEY | -40°C to +85°C | 28-pin TSSOP |
| SP3238EEY/TR | -40°C to +85°C | 28-pin TSSOP |

Available in lead free packaging. To order add "-L" suffix to part number.

Example: SP3238EEA/TR = standard; SP3238EEA-L/TR = lead free

/TR = Tape and Reel

Pack quantity is 1,500 for SSOP or TSSOP.

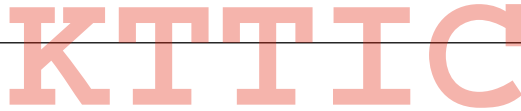

ANALOG EXCELLENCE

Sipex Corporation

Headquarters and Sales Office
233 South Hillview Drive
Milpitas, CA 95035
TEL: (408) 934-7500
FAX: (408) 935-7600

Sipex Corporation reserves the right to make changes to any products described herein. Sipex does not assume any liability arising out of the application or use of any product or circuit described herein; neither does it convey any license under its patent rights nor the rights of others.