

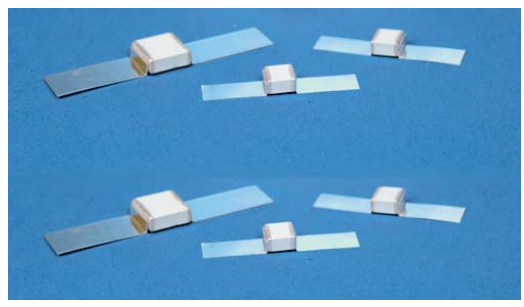

# Hi-Q High RF Power Ribbon Leded MLC Capacitors



Hi-Q®, High RF Power, Ribbon Leded MLC Capacitors from AVX Corporation are characterized with ultra-low ESR and dissipation factor at high frequencies. The HQL-style parts are constructed using non-magnetic materials. They are designed to handle high power and high voltage levels for applications in RF power amplifiers, inductive heating, high magnetic field environments (MRI coils), medical and industrial electronics.

## HOW TO ORDER

<b>HQLC</b>	<b>A</b>	<b>A</b>	<b>271</b>	<b>J</b>	<b>A</b>	<b>A</b>
<b>AVX Style</b> HQLC HQLE	<b>Voltage</b> 600V/630 = C 1000V = A 1500V = S 2000V = G 2500V = W 3000V = H 4000V = J 5000V = K 7200V = M	<b>Temperature Coefficient</b> COG = A	<b>Capacitance Code</b> (2 significant digits + no. of zeros) Examples: 4.7 pF = 4R7 10 pF = 100 100 pF = 101 1,000 pF = 102	<b>Capacitance Tolerance</b> C = ±0.25pF (<13pF) D = ±0.50pF (<25pF) F = ±1% (≥25pF) G = ±2% (≥13pF) J = ±5% K = ±10% M = ±20%	<b>Test Level</b> A = Standard	<b>Lead Style</b> A = Axial Ribbon M = Microstrip

## Capacitance Range (pF)

Style	600/630 WVDC min./max.	1000 WVDC min./max.	1500 WVDC min./max.	2000 WVDC min./max.	2500 WVDC min./max.	3000 WVDC min./max.	4000 WVDC min./max.	5000 WVDC min./max.	7200 WVDC min./max.
<b>HQLC</b>	2200 - 2700	1500 - 1800	820 - 1200	470 - 680	330 - 390	3.3 - 270			
<b>HQLE</b>	5600 - 6800	3300 - 4700	2200 - 2700	1200 - 1800	820 - 1000	470 - 680	220 - 390	120 - 180	3.3 - 100

## DIELECTRIC PERFORMANCE CHARACTERISTICS

<b>Capacitance Range</b>	3.3pF to 6,800pF (25°C, 1.0 ±0.2 Vrms at 1kHz, for ≤ 1000pF use 1MHz)
<b>Capacitance Tolerances</b>	±0.25pF, ±0.50pF, ±1%, ±2%, ±5%, ±10%, ±20%
<b>Dissipation Factor</b>	0.1% Max (+25°C, 1.0 ±0.2 Vrms at 1kHz, for ≤ 1000pF use 1MHz)
<b>Operating Temperature Range</b>	-55°C to +125°C
<b>Temperature Characteristics</b>	COG: 0 ± 30 ppm/°C (-55°C to +125°C)
<b>Voltage Ratings</b>	600, 630, 1000, 1500, 2000, 2500, 3000, 4000, 5000, 7200VDC
<b>Insulation Resistance</b>	100K MΩ min. @ +25°C and 500VDC 10K MΩ min. @ +125°C and 500VDC
<b>Dielectric Strength</b>	Minimum 120% of rated WVDC

# Hi-Q® High RF Power Ribbon Ledged MLC Capacitors

## Microstrip Leads (Lead Style "M")

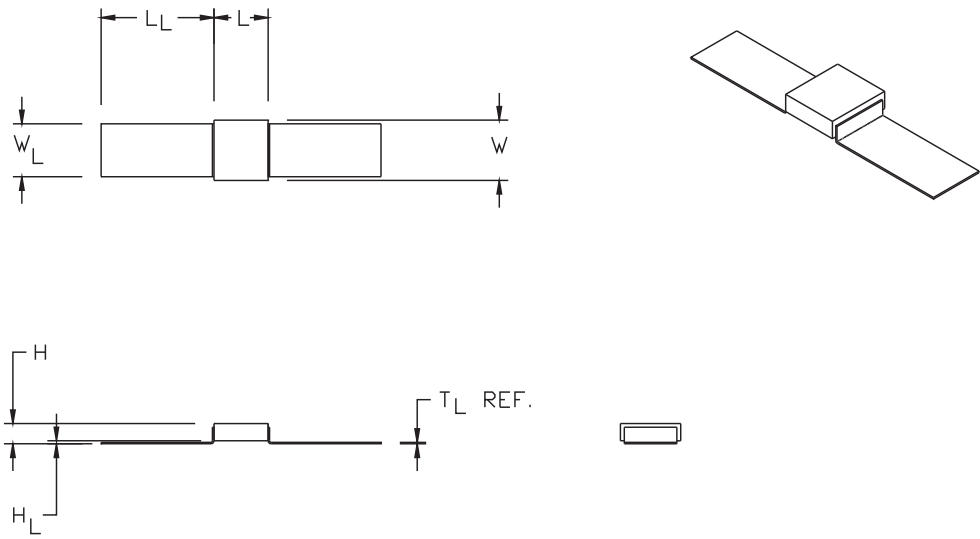

DIMENSIONS millimeters (inches)							
Unit Size	L ±0.51 (0.020)	LL Min.	W ±0.64 (0.025)	WL ±0.38 (0.015)	H ±0.64 (0.025)	HL ±0.38 (0.015)	TL Ref.
HQLC	5.72 (0.225)	12.7 (0.500)	6.35 (0.250)	6.10 (0.240)	3.68 (0.145)	0.64 (0.025)	0.10 (0.004)
HQLE	9.40 (0.370)	19.1 (0.750)	10.2 (0.400)	8.89 (0.350)	3.68 (0.145)	0.64 (0.025)	0.25 (0.010)

Note: Side to side lead alignment shall be within ±0.25 (0.010)

## Axial Ribbon Leads (Lead Style "A")

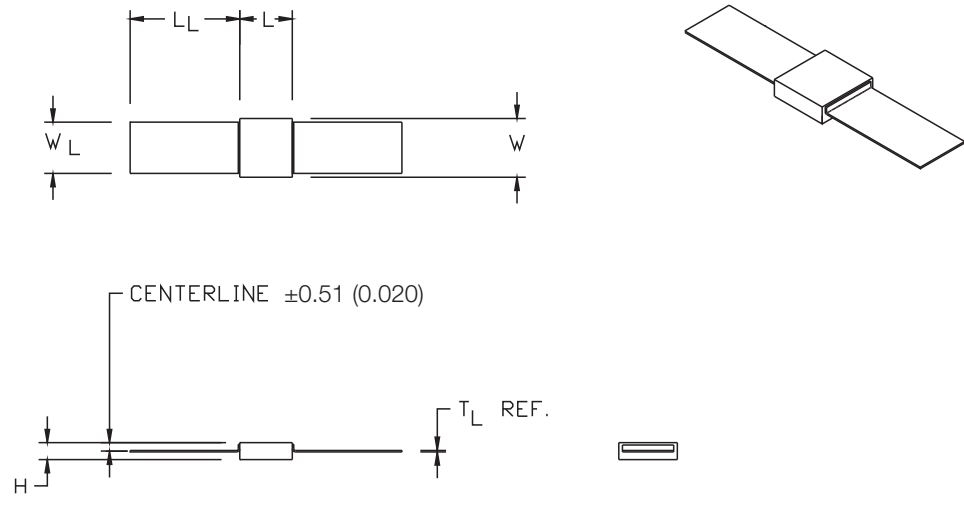

DIMENSIONS millimeters (inches)						
Unit Size	L ±0.51 (0.020)	LL Min.	W ±0.64 (0.025)	WL ±0.38 (0.015)	H ±0.64 (0.025)	TL Ref.
HQLC	5.72 (0.225)	12.7 (0.500)	6.35 (0.250)	6.10 (0.240)	3.18 (0.125)	0.10 (0.004)
HQLE	9.40 (0.370)	19.1 (0.750)	10.2 (0.400)	8.89 (0.350)	3.18 (0.125)	0.25 (0.010)

Note: Side to side lead alignment shall be within ±0.25 (0.010)

# Hi-Q<sup>®</sup> High RF Power MLC Capacitors

## PERFORMANCE CHARACTERISTICS

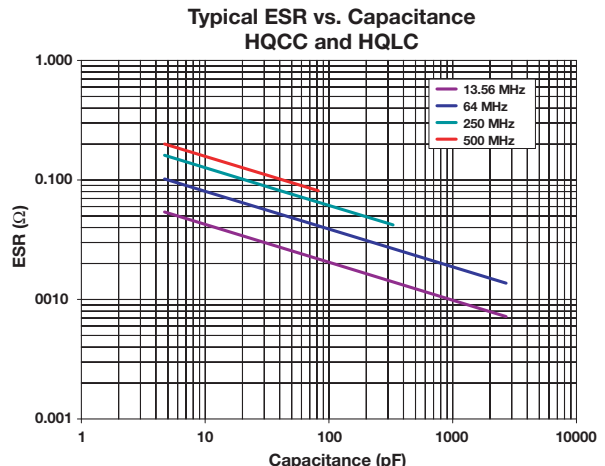
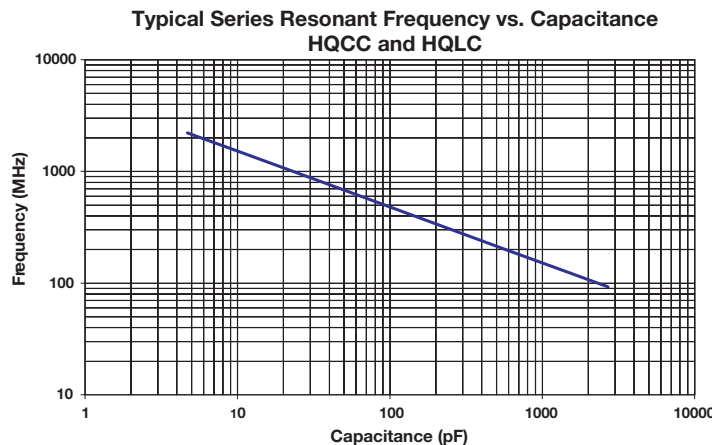

KTTIC

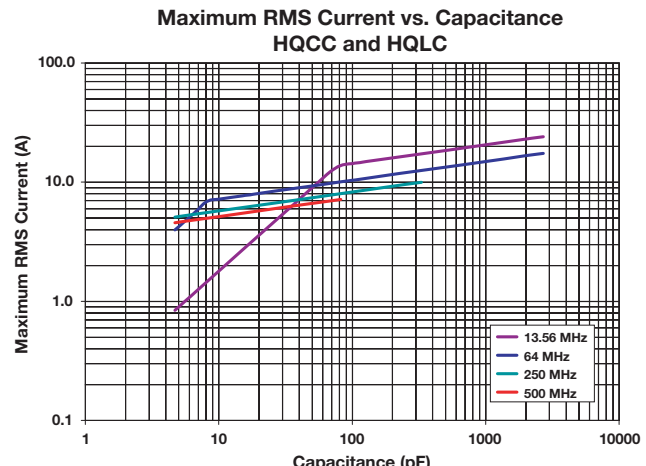
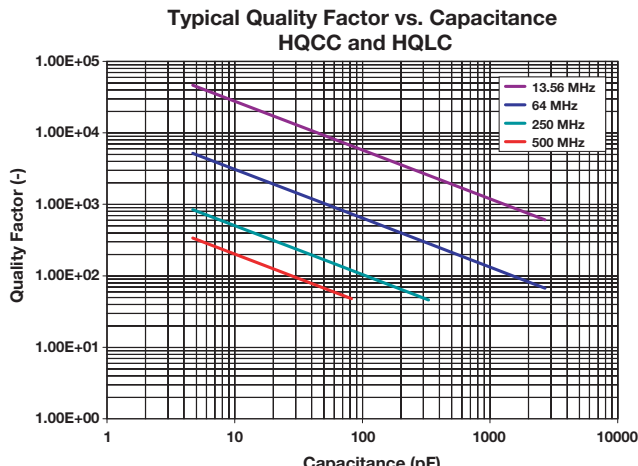

# Hi-Q<sup>®</sup> High RF Power MLC Capacitors

## PERFORMANCE CHARACTERISTICS

Typical Series Resonant Frequency vs. Capacitance  
HQCE and HQLE

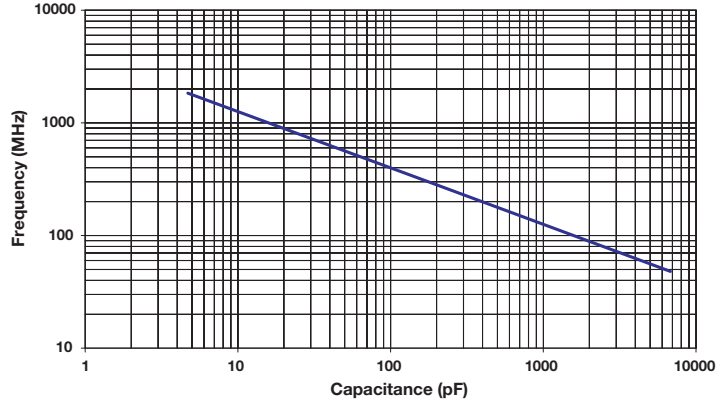

Typical ESR vs. Capacitance  
HQCE and HQLE

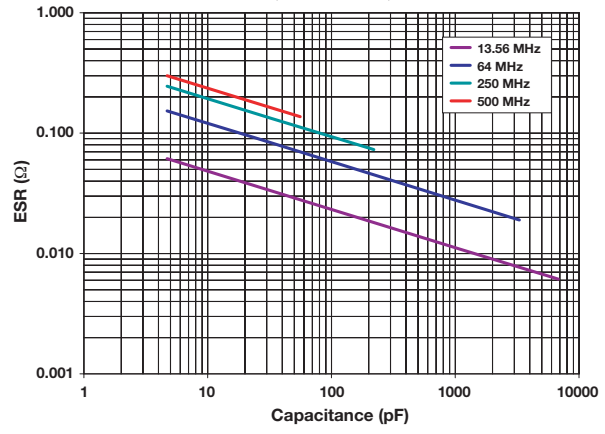

KTTIC

Typical Quality Factor vs. Capacitance  
HQCE and HQLE

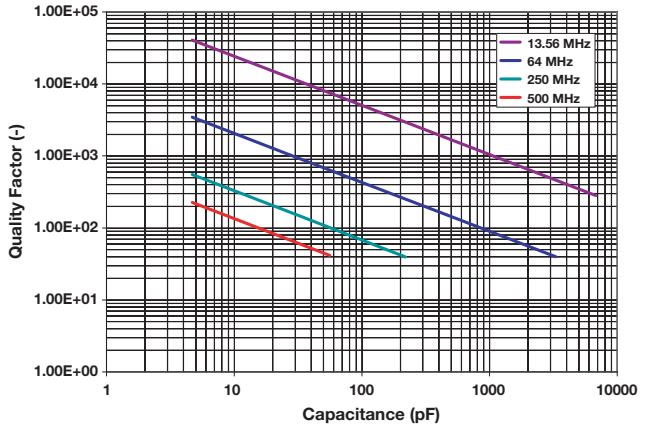

Maximum RMS Current vs. Capacitance  
HQCE and HQLE

