

Features

- Industry Standard Architecture
 - Low-cost Easy-to-use Software Tools
- High-speed, Electrically-erasable Programmable Logic Devices
 - 7.5 ns Maximum Pin-to-pin Delay
- Several Power Saving Options

| Device | I _{CC} , Standby | I _{CC} , Active |
|----------------------------|---------------------------|--------------------------|
| ATF22V10B | 85 mA | 90 mA |
| ATF22V10BQ ⁽¹⁾ | 35 mA | 40 mA |
| ATF22V10BQL ⁽²⁾ | 5 mA | 20 mA |

Notes: 1. The shaded devices are obsolete. Suggested replacement: ATF22V10CQ
 2. The shaded devices are obsolete. Suggested replacement: ATF22V10CQZ

- CMOS and TTL Compatible Inputs and Outputs
 - Input and I/O Pull-up Resistors
- Advanced Flash Technology
 - Reprogrammable
 - 100% Tested
- High-reliability CMOS Process
 - 20-year Data Retention
 - 100 Erase/Write Cycles
 - 2,000V ESD Protection
 - 200 mA Latchup Immunity
- Full Military, Commercial, and Industrial Temperature Ranges
- Dual-in-line and Surface Mount Packages in Standard Pinouts
- PCI Compliant



High-performance
EE PLD

ATF22V10B

Logic Diagram

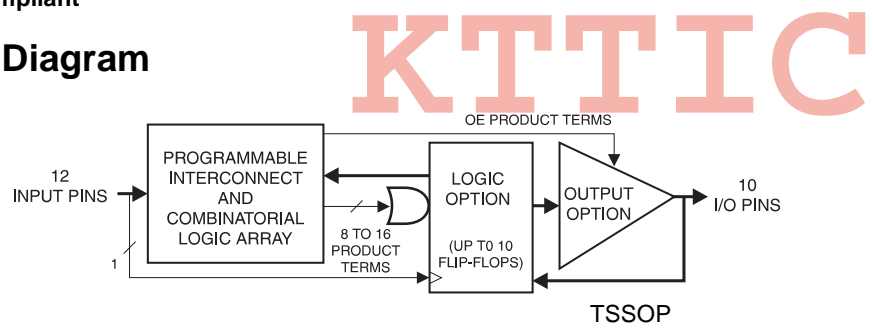

Pin Configurations

All Pinouts Top View

| Pin Name | Function |
|-----------------|------------------------|
| CLK | Clock |
| IN | Logic Inputs |
| I/O | Bidirectional Buffers |
| * | No Internal Connection |
| V _{CC} | +5V Supply |

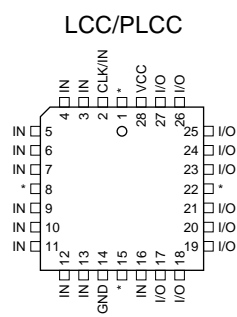
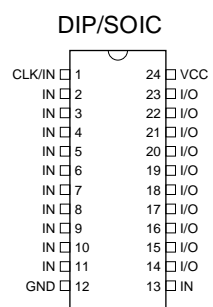
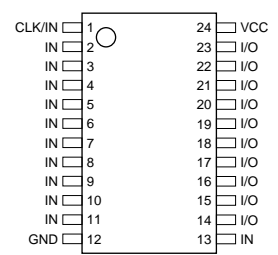

Rev. 0250L-PLD-06/03



Description

The ATF22V10B is a high-performance CMOS (electrically-erasable) programmable logic device (PLD) which utilizes Atmel's proven electrically-erasable Flash memory technology. Speeds down to 7.5 ns and power dissipation as low as 10 mA are offered. All speed ranges are specified over the full $5V \pm 10\%$ range for military and industrial

temperature ranges, and $5V \pm 5\%$ for commercial temperature ranges.

Several low-power options allow selection of the best solution for various types of power-limited applications. Each of these options significantly reduces total system power and enhances system reliability.

Absolute Maximum Ratings*

| | |
|--|--------------------------------|
| Temperature Under Bias..... | -55°C to +125°C |
| Storage Temperature | -65°C to +150°C |
| Voltage on Any Pin with Respect to Ground | -2.0V to +7.0V ⁽¹⁾ |
| Voltage on Input Pins with Respect to Ground During Programming..... | -2.0V to +14.0V ⁽¹⁾ |
| Programming Voltage with Respect to Ground | -2.0V to +14.0V ⁽¹⁾ |

*NOTICE: Stresses beyond those listed under "Absolute Maximum Ratings" may cause permanent damage to the device. This is a stress rating only and functional operation of the device at these or any other conditions beyond those indicated in the operational sections of this specification is not implied. Exposure to absolute maximum rating conditions for extended periods may affect device reliability.

Note: 1. Minimum voltage is -0.6V DC, which may undershoot to -2.0V for pulses of less than 20 ns. Maximum output pin voltage is $V_{CC} + 0.75V$ DC, which may overshoot to 7.0V for pulses of less than 20 ns.

DC and AC Operating Conditions

| | Commercial | Industrial | Military |
|-----------------------|----------------------|------------------------|----------------------|
| Operating Temperature | 0°C - 70°C (Ambient) | -40°C - 85°C (Ambient) | -55°C - 125°C (Case) |
| V_{CC} Power Supply | $5V \pm 5\%$ | $5V \pm 10\%$ | $5V \pm 10\%$ |

Note: 1. The shaded devices are obsolete.

DC Characteristics

| Symbol | Parameter | Condition | Min | Typ | Max | Units | |
|----------------|-----------------------------------|---|----------------------------|------------|-----------------|---------------|----|
| I_{IL} | Input or I/O Low Leakage Current | $0 \leq V_{IN} \leq V_{IL} \text{ (Max)}$ | | -35 | -100 | μA | |
| I_{IH} | Input or I/O High Leakage Current | $3.5 \leq V_{IN} \leq V_{CC}$ | | | 10 | μA | |
| I_{CC} | Power Supply Current, Standby | $V_{CC} = \text{Max}, V_{IN} = \text{Max}, \text{Outputs Open}$ | B-7 | Com. | 85 | 120 | mA |
| | | | | Ind., Mil. | 85 | 140 | mA |
| I_{CC} | Power Supply Current, Standby | $V_{CC} = \text{Max}, V_{IN} = \text{Max}, \text{Outputs Open}$ | B-10 | Com./Ind. | 85/85 | 120/140 | mA |
| | | | | Mil. | 85 | 140 | mA |
| | | | B-15 | Com./Ind. | 65/65 | 90/115 | mA |
| | | | | Mil. | 65 | 115 | mA |
| | | | B-25 | Com. | 65 | 90 | mA |
| | | | | Ind., Mil. | 65 | 115 | mA |
| | | | BQ-15 | Com. | 35 | 55 | mA |
| | | | BQL-20, -25 | Com. | 5 | 10 | mA |
| Ind., Mil. | 5 | 15 | | mA | | | |
| I_{CC2} | Clocked Power Supply Current | $V_{CC} = \text{Max}, \text{Outputs Open}, f = 15 \text{ MHz}$ | B-7 | Com. | 90 | 120 | mA |
| | | | | Mil., Ind. | 90 | 145 | mA |
| | | | B-10 | Com./Ind. | 90/90 | 120/145 | mA |
| | | | | Mil. | 90 | 145 | mA |
| | | | B-15 | Com./Ind. | 65/65 | 90/120 | mA |
| | | | | Mil. | 65 | 120 | mA |
| | | | B-25 | Com. | 65 | 90 | mA |
| | | | | Ind., Mil. | 65 | 120 | mA |
| | | | BQ-15 | Com. | 40 | 60 | mA |
| | | | BQL-20, -25 | Com. | 20 | 50 | mA |
| Ind., Mil. | 20 | 70 | | mA | | | |
| $I_{OS}^{(1)}$ | Output Short Circuit Current | $V_{OUT} = 0.5\text{V}$ | | | -130 | mA | |
| V_{IL} | Input Low Voltage | | -0.5 | | 0.8 | V | |
| V_{IH} | Input High Voltage | | 2.0 | | $V_{CC} + 0.75$ | V | |
| V_{OL} | Output Low Voltage | $V_{IN} = V_{IH} \text{ or } V_{IL}, V_{CC} = \text{Min}$ | $I_{OL} = 16 \text{ mA}$ | Com., Ind. | | 0.5 | V |
| | | | $I_{OL} = 12 \text{ mA}$ | Mil. | | 0.5 | V |
| V_{OH} | Output High Voltage | $V_{IN} = V_{IH} \text{ or } V_{IL}, V_{CC} = \text{Min}$ | $I_{OH} = -4.0 \text{ mA}$ | 2.4 | | V | |

Notes: 1. Not more than one output at a time should be shorted. Duration of short circuit test should not exceed 30 sec.
 2. The shaded devices are obsolete.



Input Test Waveforms and Measurement Levels

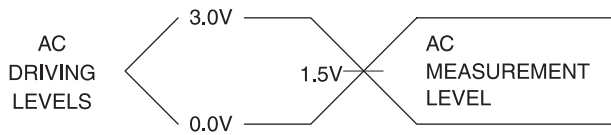

$t_R, t_F < 3 \text{ ns}$

Output Test Loads

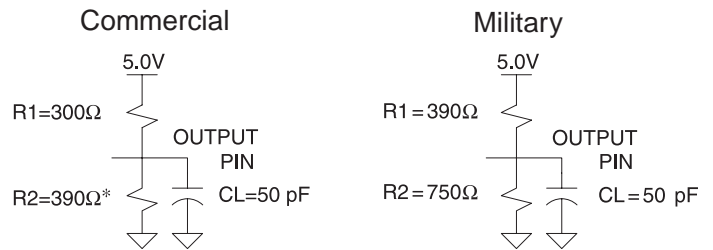

* All except -7 which is R2 = 300Ω

Pin Capacitance

$f = 1 \text{ MHz}, T = 25^\circ\text{C}^{(1)}$

| | Typ | Max | Units | Conditions |
|-----------|-----|-----|-------|----------------|
| C_{IN} | 5 | 8 | pF | $V_{IN} = 0V$ |
| C_{OUT} | 6 | 8 | pF | $V_{OUT} = 0V$ |

Note: 1. Typical values for nominal supply voltage. This parameter is only sampled and is not 100% tested.

Power-up Reset

The registers in the ATF22V10Bs are designed to reset during power-up. At a point delayed slightly from V_{CC} crossing V_{RST} , all registers will be reset to the low state. The output state will depend on the polarity of the output buffer.

This feature is critical for state machine initialization. However, due to the asynchronous nature of reset and the uncertainty of how V_{CC} actually rises in the system, the following conditions are required:

1. The V_{CC} rise must be monotonic,
2. After reset occurs, all input and feedback setup times must be met before driving the clock pin high, and
3. The clock must remain stable during t_{PR} .

Preload of Registered Outputs

The ATF22V10B's registers are provided with circuitry to allow loading of each register with either a high or a low. This feature will simplify testing since any state can be forced into the registers to control test sequencing. A JEDEC file with preload is generated when a source file with vectors is compiled. Once downloaded, the JEDEC file preload sequence will be done automatically by most of the approved programmers after the programming.

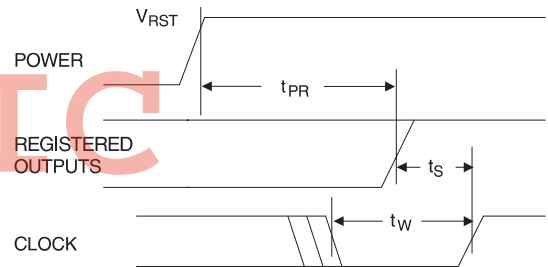

| Parameter | Description | Typ | Max | Units |
|-----------|------------------------|-----|-------|-------|
| t_{PR} | Power-up Reset Time | 600 | 1,000 | ns |
| V_{RST} | Power-up Reset Voltage | 3.8 | 4.5 | V |

Security Fuse Usage

A single fuse is provided to prevent unauthorized copying of the ATF22V10B fuse patterns. Once programmed, fuse verify and preload are inhibited. However, the 64-bit User Signature remains accessible.

The security fuse should be programmed last, as its effect is immediate.

Electronic Signature Word

There are 64 bits of programmable memory that are always available to the user, even if the device is secured. These bits can be used for user-specific data.

Programming/Erasing

Programming/erasing is performed using standard PLD programmers. See *CMOS PLD Programming Hardware and Software Support* for information on software/programming.

Input and I/O Pull-ups

All ATF22V10B family members have internal input and I/O pull-up resistors. Therefore, whenever inputs or I/Os are not being driven externally, they will float to V_{CC} . This ensures that all logic array inputs are at known states. These are relatively weak active pull-ups that can easily be overdriven by TTL-compatible drivers (see input and I/O diagrams below).

Input Diagram

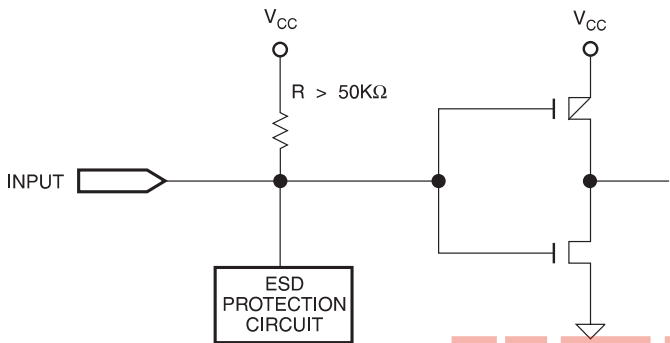

I/O Diagram

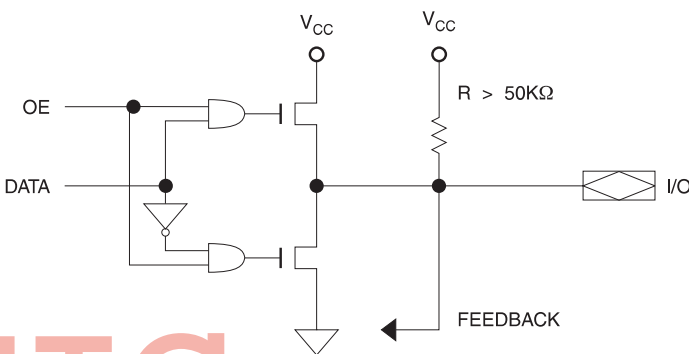

Functional Logic Diagram ATF22V10B

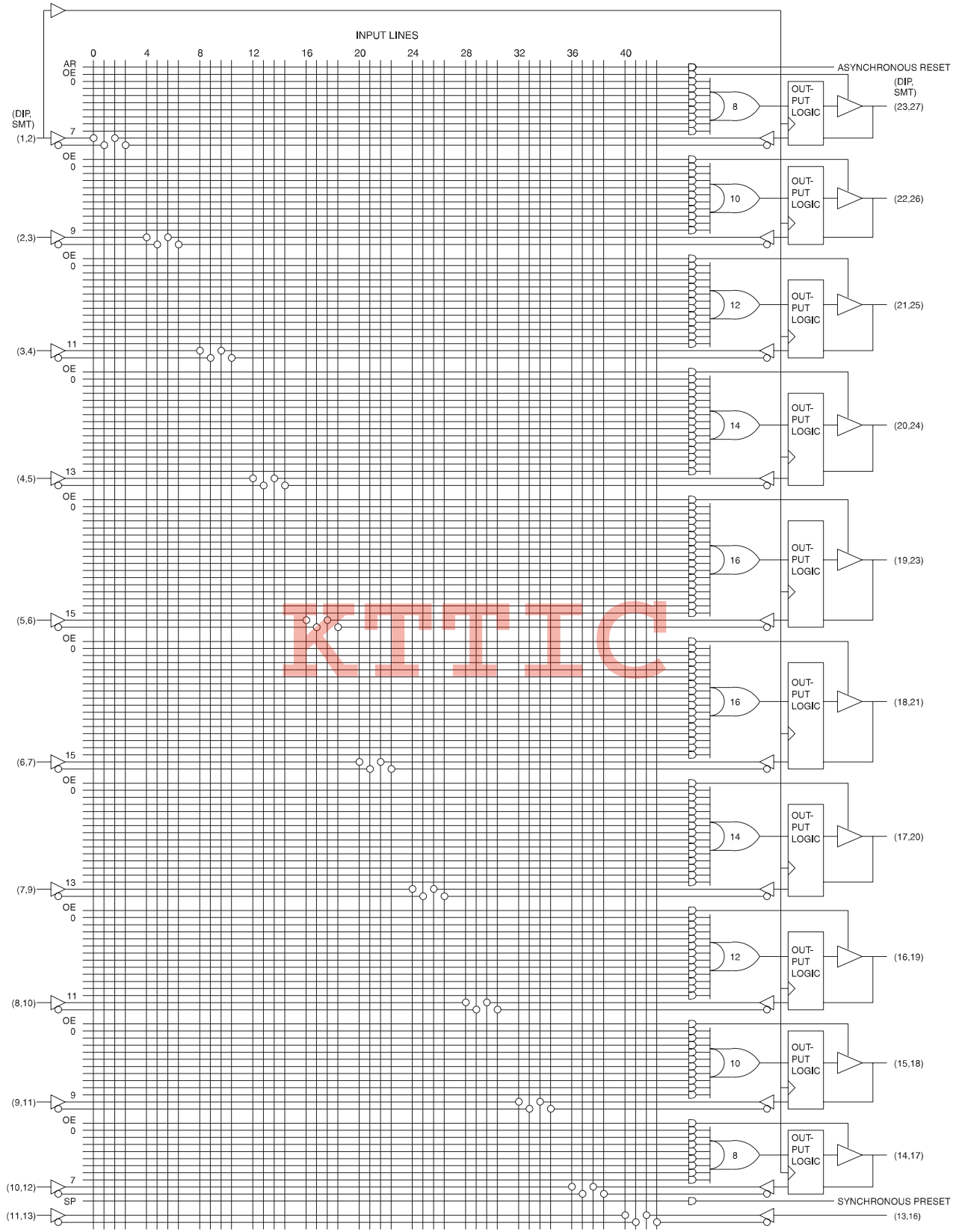

SUPPLY CURRENT vs. INPUT FREQUENCY
ATF22V10B/BQ (VCC = 5V, TA = 25°C)

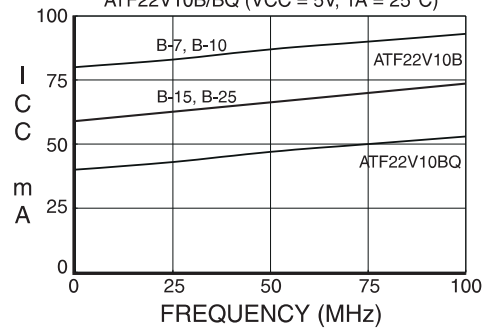

SUPPLY CURRENT vs. INPUT FREQUENCY
ATF22V10BL/BQL (VCC = 5V, TA = 25°C)

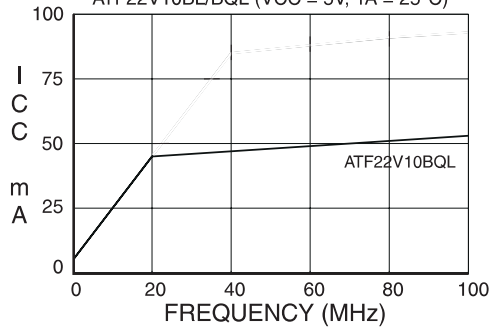

SUPPLY CURRENT vs. SUPPLY VOLTAGE
ATF22V10B/BQ (TA = 25°C)

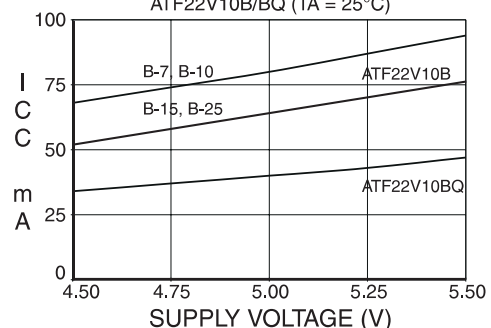

SUPPLY CURRENT vs. SUPPLY VOLTAGE
ATF22V10BL/BQL (TA = 25°C)

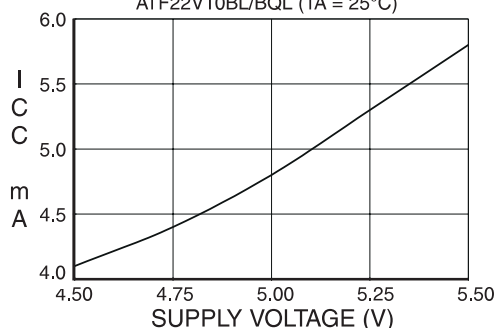

SUPPLY CURRENT vs. AMBIENT TEMPERATURE
ATF22V10B/BQ (VCC = 5V)

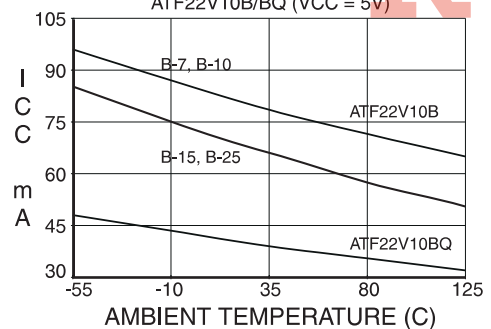

SUPPLY CURRENT vs. AMBIENT TEMPERATURE
ATF22V10BL/BQL (VCC = 5V)

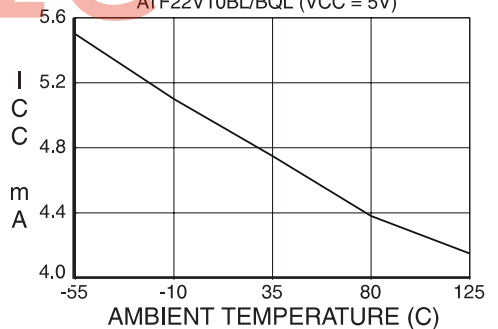

OUTPUT SOURCE CURRENT
vs. SUPPLY VOLTAGE (VOH = 2.4V)

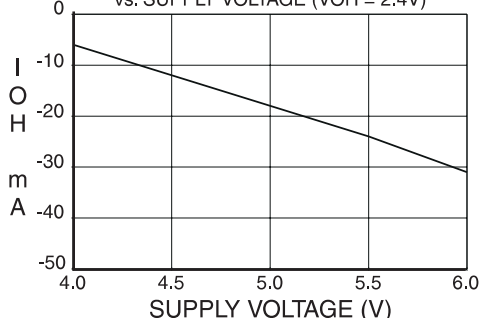

OUTPUT SINK CURRENT
vs. SUPPLY VOLTAGE (VOL = 0.5V)

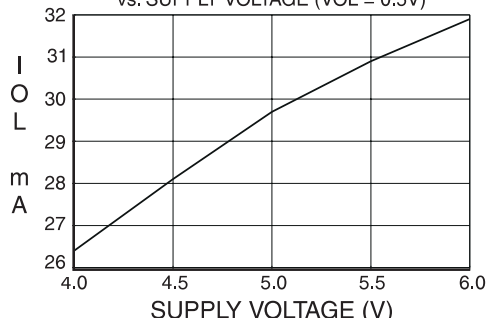

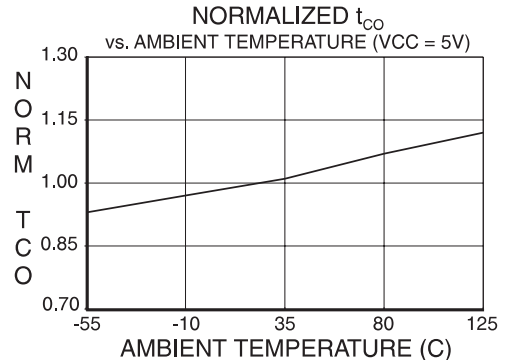
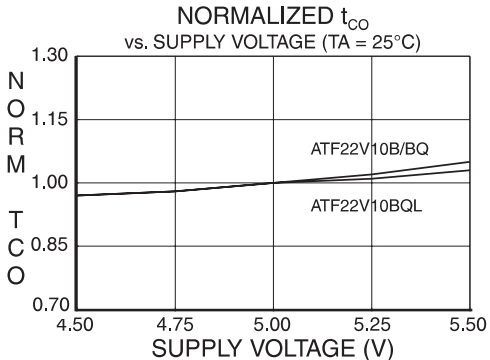
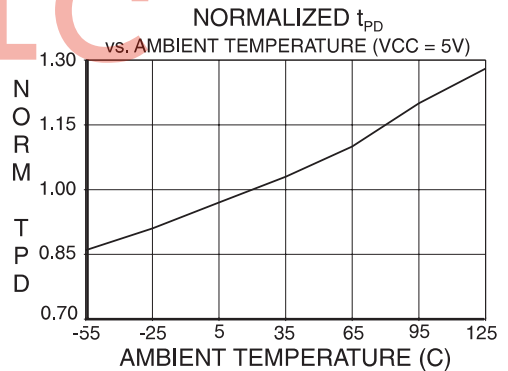
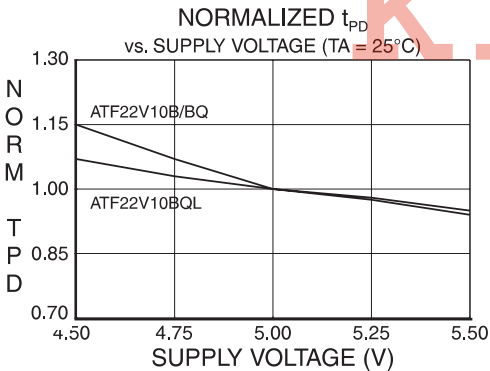
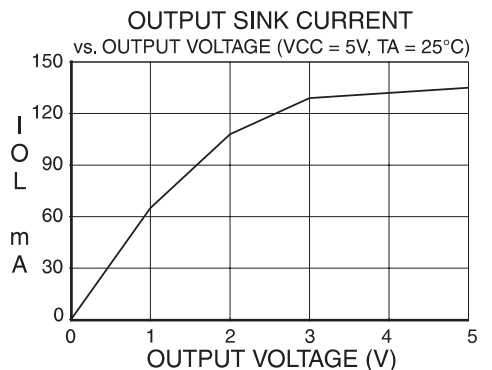
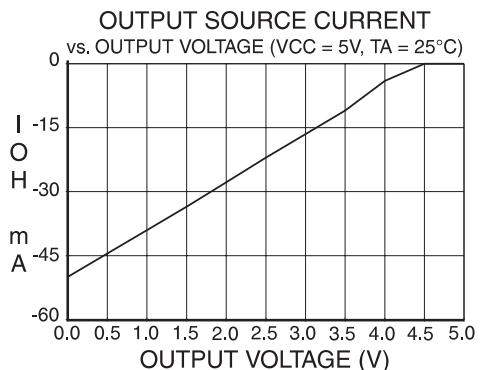
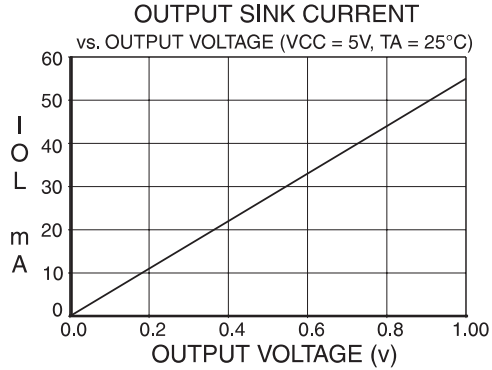
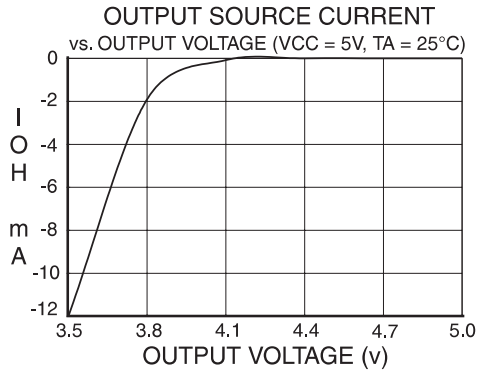

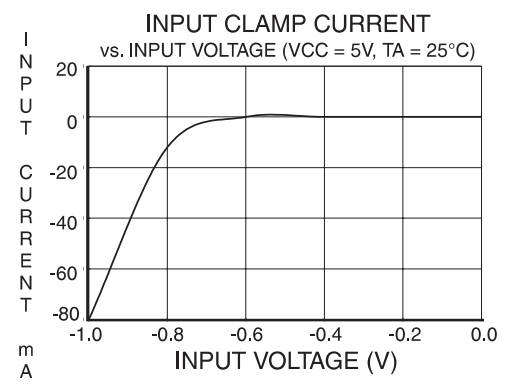
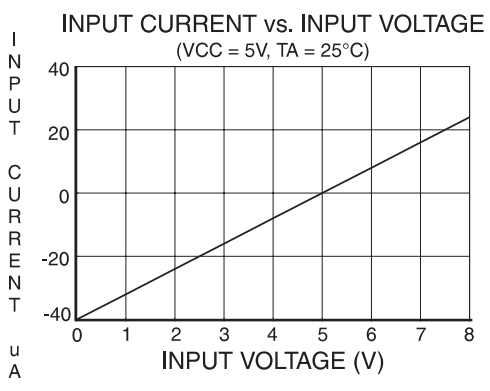
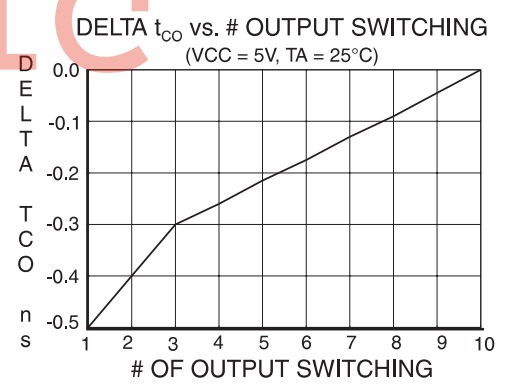
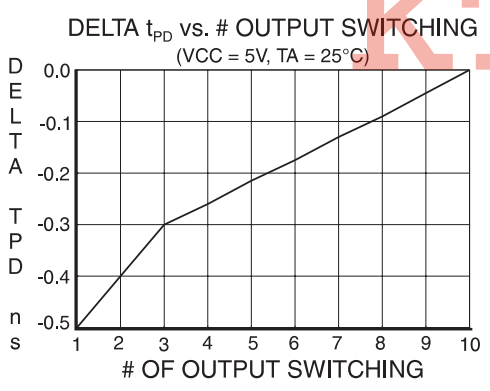
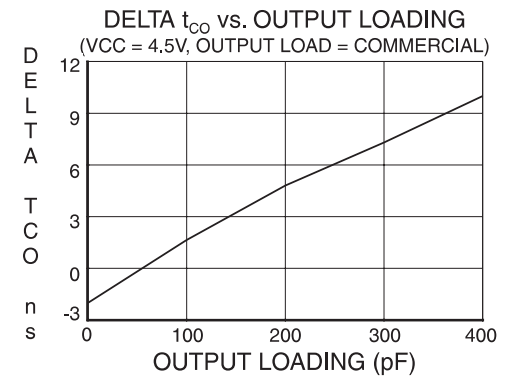
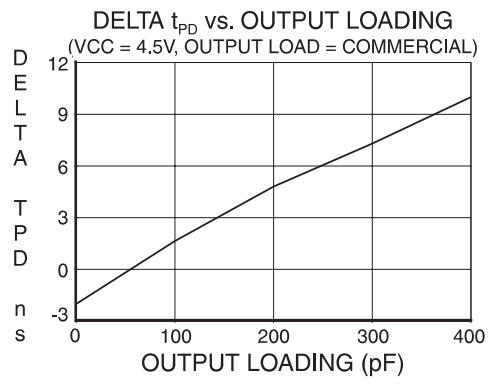
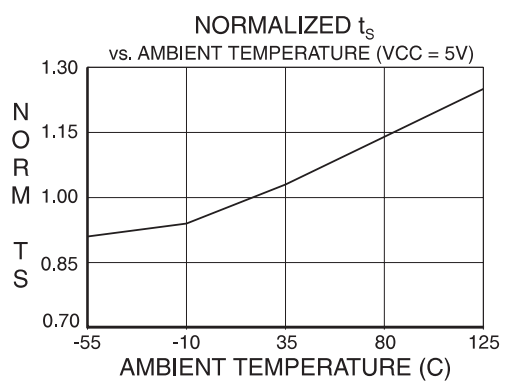
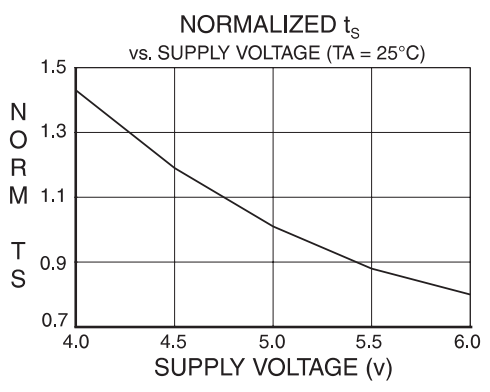

KTTIC

ATF22V10B Ordering Information

| t_{PD} (ns) | t_S (ns) | t_{CO} (ns) | Ordering Code | Package | Operation Range |
|---------------|------------|---------------|-------------------------------|---------|---|
| 7.5 | 3.5 | 4.5 | ATF22V10B-7JC ⁽¹⁾ | 28J | Commercial (0°C to 70°C) |
| | | | ATF22V10B-7PC ⁽¹⁾ | 24P3 | |
| | | | ATF22V10B-7SC ⁽¹⁾ | 24S | |
| | | | ATF22V10B-7XC ⁽¹⁾ | 24X | |
| 10 | 4.5 | 6.5 | ATF22V10B-10JC ⁽¹⁾ | 28J | Commercial (0°C to 70°C) |
| | | | ATF22V10B-10PC ⁽¹⁾ | 24P3 | |
| | | | ATF22V10B-10SC ⁽¹⁾ | 24S | |
| | | | ATF22V10B-10XC ⁽¹⁾ | 24X | |
| | | | ATF22V10B-10JI ⁽¹⁾ | 28J | Industrial (-40°C to 85°C) |
| | | | ATF22V10B-10PI ⁽¹⁾ | 24P3 | |
| | | | ATF22V10B-10SI ⁽¹⁾ | 24S | |
| | | | ATF22V10B-10XI ⁽¹⁾ | 24X | |
| | | | ATF22V10B-10GM/883 | 24D3 | Military/883C (-55°C to 125°C) Class B, Fully Compliant |
| | | | ATF22V10B-10NM/883 | 28L | |
| | | | 5962-89841 06LA | 24D3 | Military (-55°C to 125°C) Class B, Fully Compliant |
| | | | 5962-89841 063X | 28L | |
| 15 | 10 | 8 | ATF22V10B-15JC ⁽¹⁾ | 28J | Commercial (0°C to 70°C) |
| | | | ATF22V10B-15PC ⁽¹⁾ | 24P3 | |
| | | | ATF22V10B-15SC ⁽¹⁾ | 24S | |
| | | | ATF22V10B-15XC ⁽¹⁾ | 24X | |
| | | | ATF22V10B-15JI ⁽¹⁾ | 28J | Industrial (-40°C to 85°C) |
| | | | ATF22V10B-15PI ⁽¹⁾ | 24P3 | |
| | | | ATF22V10B-15SI ⁽¹⁾ | 24S | |
| | | | ATF22V10B-15XI ⁽¹⁾ | 24X | |
| | | | ATF22V10B-15GM/883 | 24D3 | Military/883C (-55°C to 125°C) Class B, Fully Compliant |
| | | | ATF22V10B-15NM/883 | 28L | |
| | | | 5962-89841 03LA | 24D3 | Military (-55°C to 125°C) Class B, Fully Compliant |
| | | | 5962-89841 033X | 28L | |
| 25 | 15 | 15 | ATF22V10B-25JC | 28J | Commercial (0°C to 70°C) |
| | | | ATF22V10B-25PC | 24P3 | |
| | | | ATF22V10B-25SC | 24S | |
| | | | ATF22V10B-25XC | 24X | |
| | | | ATF22V10B-25JI | 28J | Industrial (-40°C to 85°C) |
| | | | ATF22V10B-25PI | 24P3 | |
| | | | ATF22V10B-25SI | 24S | |
| | | | ATF22V10B-25XI | 24X | |

Notes: 1. Recommend ATF22V10C versions.
2. The shaded devices are obsolete.



ATF22V10BQ(L) Ordering Information

| t_{PD} (ns) | t_S (ns) | t_{CO} (ns) | Ordering Code | Package | Operation Range |
|---------------|------------|---------------|---------------------------------|---------|---|
| 15 | 10 | 8 | ATF22V10BQ-15JC ⁽¹⁾ | 28J | Commercial (0°C to 70°C) |
| | | | ATF22V10BQ-15PC ⁽¹⁾ | 24P3 | |
| | | | ATF22V10BQ-15SC ⁽¹⁾ | 24S | |
| | | | ATF22V10BQ-15XC ⁽¹⁾ | 24X | |
| 20 | 14 | 12 | ATF22V10BQL-20JC ⁽¹⁾ | 28J | Commercial (0°C to 70°C) |
| | | | ATF22V10BQL-20PC ⁽¹⁾ | 24P3 | |
| | | | ATF22V10BQL-20SC ⁽¹⁾ | 24S | |
| | | | ATF22V10BQL-20XC ⁽¹⁾ | 24X | |
| | | | ATF22V10BQL-20JI ⁽¹⁾ | 28J | Industrial (-40°C to 85°C) |
| | | | ATF22V10BQL-20PI ⁽¹⁾ | 24P3 | |
| | | | ATF22V10BQL-20SI ⁽¹⁾ | 24S | |
| | | | ATF22V10BQL-20XI ⁽¹⁾ | 24X | |
| | | | ATF22V10BQL-20GM/883 | 24D3 | Military/883C (-55°C to 125°C) Class B, Fully Compliant |
| | | | ATF22V10BQL-20NM/883 | 28L | |
| | | | 5962-89841 14 LA | 24D3 | Military (-55°C to 125°C) Class B, Fully Compliant |
| | | | 5962-89841 14 3X | 28L | |
| 25 | 15 | 15 | ATF22V10BQL-25JC | 28J | Commercial (0°C to 70°C) |
| | | | ATF22V10BQL-25PC | 24P3 | |
| | | | ATF22V10BQL-25SC | 24S | |
| | | | ATF22V10BQL-25XC | 24X | |
| | | | ATF22V10BQL-25JI | 28J | Industrial (-40°C to 85°C) |
| | | | ATF22V10BQL-25PI | 24P3 | |
| | | | ATF22V10BQL-25SI | 24S | |
| | | | ATF22V10BQL-25XI | 24X | |
| | | | ATF22V10BQL-25GM/883 | 24D3 | Military/883C (-55°C to 125°C) Class B, Fully Compliant |
| | | | ATF22V10BQL-25NM/883 | 28L | |
| | | | 5962-89841 13 LA | 24D3 | Military (-55°C to 125°C) Class B, Fully Compliant |
| | | | 5962-89841 13 3X | 28L | |

Notes: 1. Recommend ATF22V10CQ and ATF22V10CQZ
2. The shaded devices are obsolete.

Package Information

24D3

24D3, 24-lead, 0.300" Wide. Non-windowed,
Ceramic Dual Inline Package (Cerdip)
Dimensions in Millimeters and (Inches)*
MIL-STD-1835 D-9 CONFIG A (Glass Sealed)

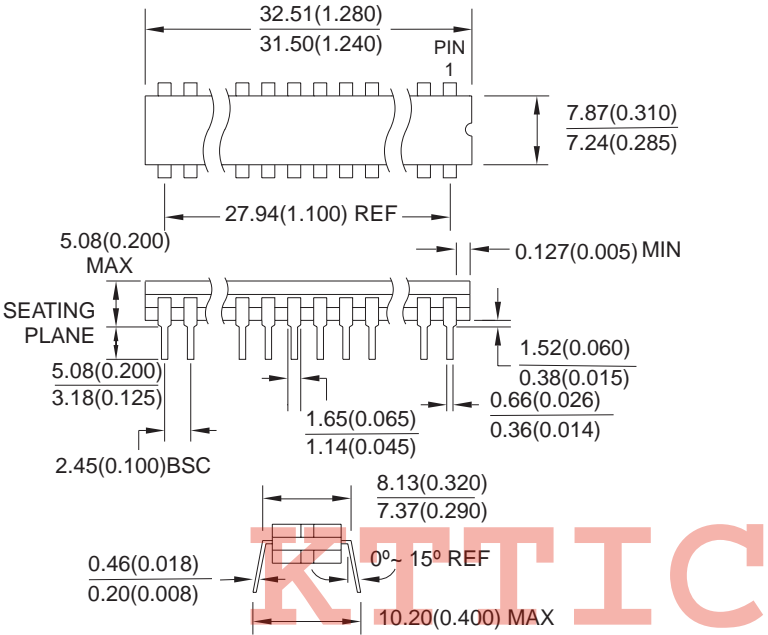

*Controlling dimension: Inches

REV. A 04/11/2001



28L

28L, 28-pad, Non-windowed, Ceramic lid, Leadless Chip Carrier (LCC)
 Dimensions in Millimeters and (Inches)*
 MIL-STD-1835 C-4

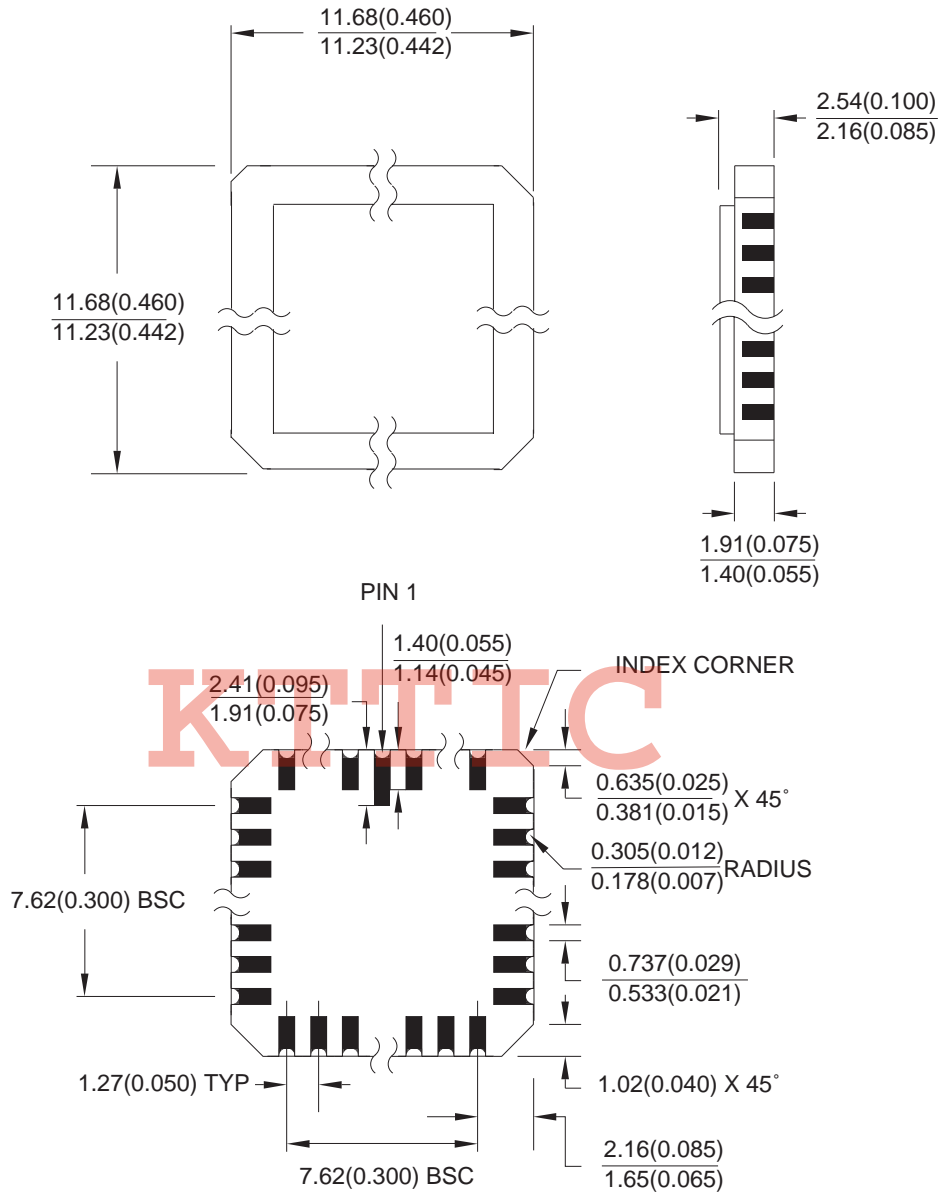

*Controlling dimension: Inches