

Features

- Fast Read Access Time – 55 ns
- Low Power CMOS Operation
 - 100 μ A Maximum Standby
 - 40 mA Maximum Active at 5 MHz
- JEDEC Standard Packages
 - 40-lead PDIP
 - 44-lead PLCC
 - 40-lead VSOP
- Direct Upgrade from 512-Kbit, 1-Mbit, and 2-Mbit (AT27C516, AT27C1024, and AT27C2048) EPROMs
- 5V \pm 10% Power Supply
- High Reliability CMOS Technology
 - 2,000V ESD Protection
 - 200 mA Latchup Immunity
- Rapid Programming Algorithm – 50 μ s/Word (Typical)
- CMOS and TTL Compatible Inputs and Outputs
- Integrated Product Identification Code
- Industrial Temperature Range
- Green (Pb/Halide-free) Packaging Option

1. Description

The AT27C4096 is a low-power, high-performance 4,194,304-bit one-time programmable read-only memory (OTP EPROM) organized 256K by 16 bits. It requires a single 5V power supply in normal read mode operation. Any word can be accessed in less than 55 ns, eliminating the need for speed-reducing WAIT states. The x16 organization makes this part ideal for high-performance 16- and 32-bit microprocessor systems.

In read mode, the AT27C4096 typically consumes 15 mA. Standby mode supply current is typically less than 10 μ A.

The AT27C4096 is available in industry-standard JEDEC-approved one-time programmable (OTP) plastic PDIP, PLCC, and VSOP packages. The device features two-line control (\overline{CE} , \overline{OE}) to eliminate bus contention in high-speed systems.

With high density 256K word storage capability, the AT27C4096 allows firmware to be stored reliably and to be accessed by the system without the delays of mass storage media.

Atmel's AT27C4096 has additional features that ensure high quality and efficient production use. The Rapid Programming Algorithm reduces the time required to program the part and guarantees reliable programming. Programming time is typically only 50 μ s/word. The Integrated Product Identification Code electronically identifies the device and manufacturer. This feature is used by industry-standard programming equipment to select the proper programming algorithms and voltages.



**4-Megabit
(256K x 16)
OTP EPROM**

AT27C4096

0311I-EPROM-12/07



2. Pin Configurations

Pin Name	Function
A0 - A17	Addresses
O0 - O15	Outputs
\overline{CE}	Chip Enable
\overline{OE}	Output Enable
NC	No Connect

Note: Both GND pins must be connected.

2.1 44-lead PLCC Top View

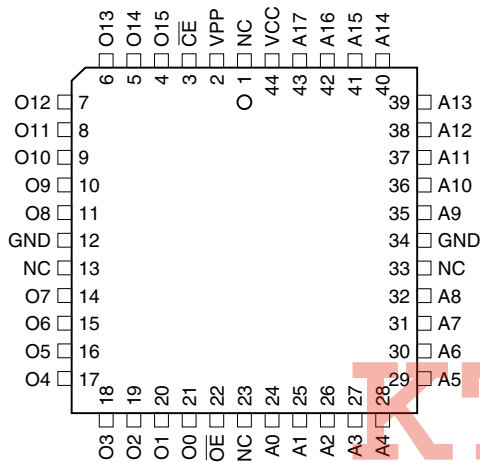

2.3 40-lead VSOP (Type 1) Top View

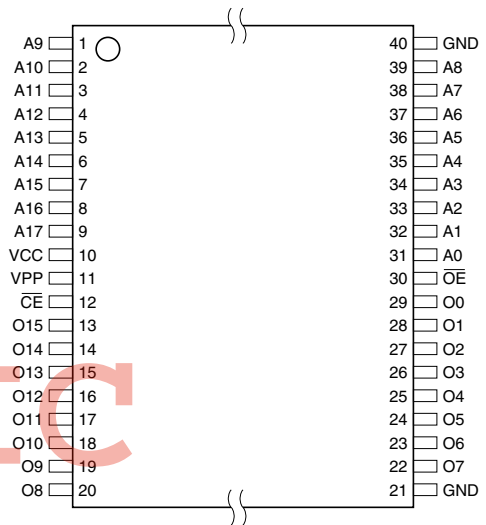

2.2 40-lead PDIP Top View

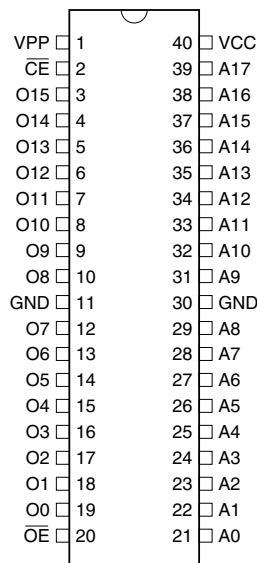

3. System Considerations

Switching between active and standby conditions via the Chip Enable pin may produce transient voltage excursions. Unless accommodated by the system design, these transients may exceed datasheet limits, resulting in device non-conformance. At a minimum, a 0.1 μ F high frequency, low inherent inductance, ceramic capacitor should be utilized for each device. This capacitor should be connected between the V_{CC} and Ground terminals of the device, as close to the device as possible. Additionally, to stabilize the supply voltage level on printed circuit boards with large EPROM arrays, a 4.7 μ F bulk electrolytic capacitor should be utilized, again connected between the V_{CC} and Ground terminals. This capacitor should be positioned as close as possible to the point where the power supply is connected to the array.

4. Block Diagram

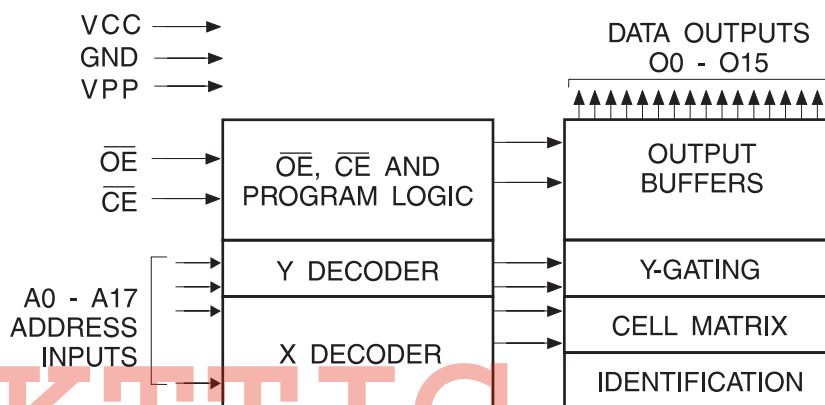

5. Absolute Maximum Ratings*

Temperature Under Bias.....	-55° C to +125° C
Storage Temperature	-65° C to +150° C
Voltage on Any Pin with Respect to Ground	-2.0V to +7.0V ⁽¹⁾
Voltage on A9 with Respect to Ground	-2.0V to +14.0V ⁽¹⁾
V_{PP} Supply Voltage with Respect to Ground	-2.0V to +14.0V ⁽¹⁾

*NOTICE: Stresses beyond those listed under “Absolute Maximum Ratings” may cause permanent damage to the device. This is a stress rating only and functional operation of the device at these or any other conditions beyond those indicated in the operational sections of this specification is not implied. Exposure to absolute maximum rating conditions for extended periods may affect device reliability.

Note: 1. Maximum voltage is -0.6V DC which may undershoot to -2.0V for pulses of less than 20 ns. Maximum output pin voltage is $V_{CC} + 0.75V$ DC which may overshoot to +7.0V for pulses of less than 20 ns.

6. Operating Modes

Mode/Pin	\overline{CE}	\overline{OE}	Ai	V _{PP}	Outputs
Read	V _{IL}	V _{IL}	Ai	X ⁽¹⁾	D _{OUT}
Output Disable	X	V _{IH}	X	X	High Z
Standby	V _{IH}	X	X	X ⁽⁵⁾	High Z
Rapid Program ⁽²⁾	V _{IL}	V _{IH}	Ai	V _{PP}	D _{IN}
PGM Verify	V _{IH}	V _{IL}	Ai	V _{PP}	D _{OUT}
PGM Inhibit	V _{IH}	V _{IH}	X	V _{PP}	High Z
Product Identification ⁽⁴⁾	V _{IL}	V _{IL}	A9 = V _H ⁽³⁾ A0 = V _{IH} or V _{IL} A1 - A17 = V _{IL}	V _{CC}	Identification Code

- Notes:
- X can be V_{IL} or V_{IH}.
 - Refer to the Programming characteristics.
 - V_H = 12.0 ± 0.5V.
 - Two identifier words may be selected. All Ai inputs are held low (V_{IL}), except A9, which is set to V_H, and A0, which is toggled low (V_{IL}) to select the Manufacturer's Identification word and high (V_{IH}) to select the Device Code word.
 - Standby V_{CC} current (I_{SB}) is specified with V_{PP} = V_{CC}. V_{CC} > V_{PP} will cause a slight increase in I_{SB}.

7. DC and AC Operating Conditions for Read Operation

	AT27C4096	
	-55	-90
Industrial Operating Temperature (Case)	-40°C - 85°C	-40°C - 85°C
V _{CC} Power Supply	5V ± 10%	5V ± 10%

8. DC and Operating Characteristics for Read Operation

Symbol	Parameter	Condition	Min	Max	Units
I _{LI}	Input Load Current	V _{IN} = 0V to V _{CC}		± 1	μA
I _{LO}	Output Leakage Current	V _{OUT} = 0V to V _{CC}		± 5	μA
I _{PP1} ⁽²⁾	V _{PP} ⁽¹⁾ Read/Standby Current	V _{PP} = V _{CC}		10	μA
I _{SB}	V _{CC} ⁽¹⁾ Standby Current	I _{SB1} (CMOS) CE = V _{CC} ± 0.3V		100	μA
		I _{SB2} (TTL) CE = 2.0 to V _{CC} + 0.5V		1	mA
I _{CC}	V _{CC} Active Current	f = 5 MHz, I _{OUT} = 0 mA, CE = V _{IL}		40	mA
V _{IL}	Input Low Voltage		-0.6	0.8	V
V _{IH}	Input High Voltage		2.0	V _{CC} + 0.5	V
V _{OL}	Output Low Voltage	I _{OL} = 2.1 mA		0.4	V
V _{OH}	Output High Voltage	I _{OH} = -400 μA	2.4		V

- Notes:
- V_{CC} must be applied simultaneously or before V_{PP} and removed simultaneously or after V_{PP}
 - V_{PP} may be connected directly to V_{CC}, except during programming. The supply current would then be the sum of I_{CC} and I_{PP}

9. AC Characteristics for Read Operation

Symbol	Parameter	Condition	AT27C4096				Units
			-55		-90		
			Min	Max	Min	Max	
$t_{ACC}^{(1)}$	Address to Output Delay	$\overline{CE} = \overline{OE} = V_{IL}$		55		90	ns
$t_{CE}^{(1)}$	\overline{CE} to Output Delay	$\overline{OE} = V_{IL}$		55		90	ns
$t_{OE}^{(1)}$	\overline{OE} to Output Delay	$\overline{CE} = V_{IL}$		20		35	ns
$t_{DF}^{(1)}$	\overline{OE} or \overline{CE} High to Output Float, Whichever Occurred First			20		20	ns
$t_{OH}^{(1)}$	Output Hold from Address, \overline{CE} or \overline{OE} , Whichever Occurred First		7		0		ns

Note: 1. See the AC Waveforms for Read Operation diagram.

10. AC Waveforms for Read Operation⁽¹⁾

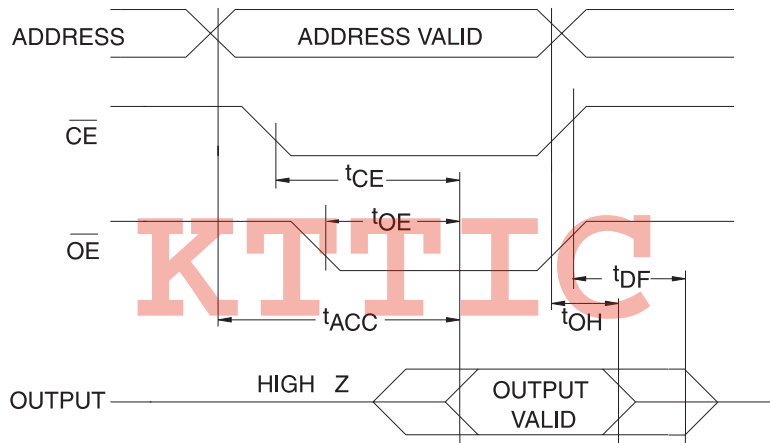

- Notes:
1. Timing measurement references are 0.8V and 2.0V. Input AC drive levels are 0.45V and 2.4V, unless otherwise specified.
 2. \overline{OE} may be delayed up to $t_{CE} - t_{OE}$ after the falling edge of \overline{CE} without impact on t_{CE} .
 3. \overline{OE} may be delayed up to $t_{ACC} - t_{OE}$ after the address is valid without impact on t_{ACC} .
 4. This parameter is only sampled and is not 100% tested.
 5. Output float is defined as the point when data is no longer driven.

11. Input Test Waveforms and Measurement Levels

For -55 devices only:

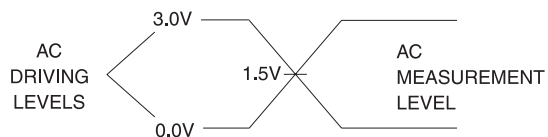

$t_R, t_F < 5 \text{ ns}$ (10% to 90%)

For -90 devices:

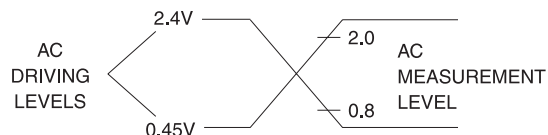

$t_R, t_F < 20 \text{ ns}$ (10% to 90%)

12. Output Test Load

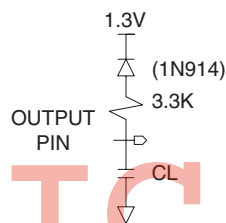

Note: $CL = 100 \text{ pF}$ including jig capacitance.

13. Pin Capacitance

$f = 1 \text{ MHz}, T = 25^\circ\text{C}^{(1)}$

Symbol	Typ	Max	Units	Conditions
C_{IN}	4	10	pF	$V_{IN} = 0V$
C_{OUT}	8	12	pF	$V_{OUT} = 0V$

Note: 1. Typical values for nominal supply voltage. This parameter is only sampled and is not 100% tested.

14. Programming Waveforms⁽¹⁾

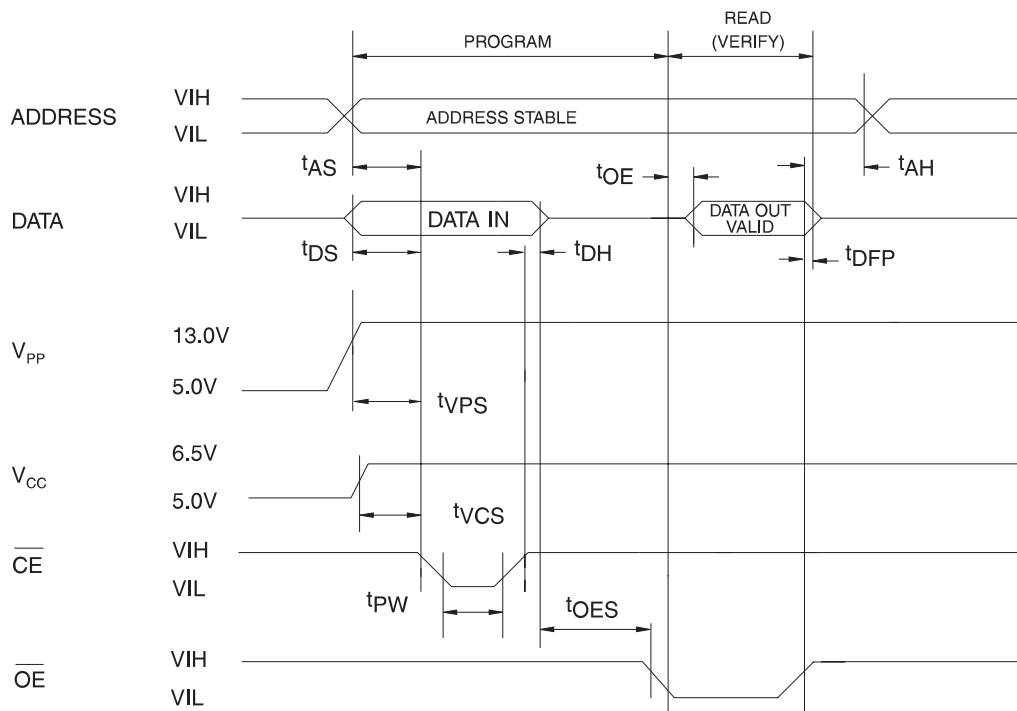

- Notes:
1. The Input Timing Reference is 0.8V for V_{IL} and 2.0V for V_{IH}.
 2. t_{OE} and t_{DFP} are characteristics of the device but must be accommodated by the programmer.
 3. When programming the AT27C4096, a 0.1 μF capacitor is required across V_{PP} and ground to suppress spurious voltage transients.

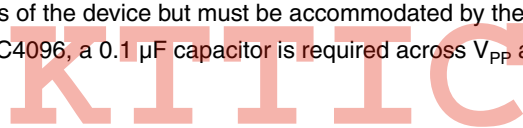

15. DC Programming Characteristics

$T_A = 25 \pm 5^\circ\text{C}$, $V_{CC} = 6.5 \pm 0.25\text{V}$, $V_{PP} = 13.0 \pm 0.25\text{V}$

Symbol	Parameter	Test Conditions	Limits		Units
			Min	Max	
I_{LI}	Input Load Current	$V_{IN} = V_{IL}, V_{IH}$		± 10	μA
V_{IL}	Input Low Level		-0.6	0.8	V
V_{IH}	Input High Level		2.0	$V_{CC} + 0.7$	V
V_{OL}	Output Low Voltage	$I_{OL} = 2.1 \text{ mA}$		0.4	V
V_{OH}	Output High Voltage	$I_{OH} = -400 \mu\text{A}$	2.4		V
I_{CC2}	V_{CC} Supply Current (Program and Verify)			50	mA
I_{PP2}	V_{PP} Supply Current	$\overline{CE} = V_{IL}$		30	mA
V_{ID}	A9 Product Identification Voltage		11.5	12.5	V

16. AC Programming Characteristics

$T_A = 25 \pm 5^\circ\text{C}$, $V_{CC} = 6.5 \pm 0.25\text{V}$, $V_{PP} = 13.0 \pm 0.25\text{V}$

Symbol	Parameter	Test Conditions ⁽¹⁾	Limits		Units
			Min	Max	
t_{AS}	Address Setup Time	Input Rise and Fall Times : (10% to 90%) 20 ns	2		μs
t_{OES}	\overline{OE} Setup Time		2		μs
t_{DS}	Data Setup Time		2		μs
t_{AH}	Address Hold Time	Input Pulse Levels: 0.45V to 2.4V	0		μs
t_{DH}	Data Hold Time		2		μs
t_{DFP}	\overline{OE} High to Output Float Delay ⁽²⁾		0	130	ns
t_{VPS}	V_{PP} Setup Time	Input Timing Reference Level: 0.8V to 2.0V	2		μs
t_{VCS}	V_{CC} Setup Time		2		μs
t_{PW}	\overline{CE} Program Pulse Width ⁽³⁾	Output Timing Reference Level: 0.8V to 2.0V	47.5	52.5	μs
t_{OE}	Data Valid from \overline{OE}			150	ns
t_{PRT}	V_{PP} Pulse Rise Time During Programming		50		ns

- Notes:
- V_{CC} must be applied simultaneously or before V_{PP} and removed simultaneously or after V_{PP}
 - This parameter is only sampled and is not 100% tested. Output Float is defined as the point where data is no longer driven – see timing diagram.
 - Program Pulse width tolerance is $50 \mu\text{sec} \pm 5\%$.

17. Atmel's AT27C4096 Intergrated Product Identification Code

Codes	Pins										Hex Data
	A0	O15-O8	O7	O6	O5	O4	O3	O2	O1	O0	
Manufacturer	0	0	0	0	0	1	1	1	1	0	001E
Device Type	1	0	1	1	1	1	0	1	0	0	00F4

18. Rapid Programming Algorithm

A 50 μs $\overline{\text{CE}}$ pulse width is used to program. The address is set to the first location. V_{CC} is raised to 6.5V and V_{PP} is raised to 13.0V. Each address is first programmed with one 50 μs $\overline{\text{CE}}$ pulse without verification. Then a verification/reprogramming loop is executed for each address. In the event a word fails to pass verification, up to 10 successive 50 μs pulses are applied with a verification after each pulse. If the word fails to verify after 10 pulses have been applied, the part is considered failed. After the word verifies properly, the next address is selected until all have been checked. V_{PP} is then lowered to 5.0V and V_{CC} to 5.0V. All words are read again and compared with the original data to determine if the device passes or fails.

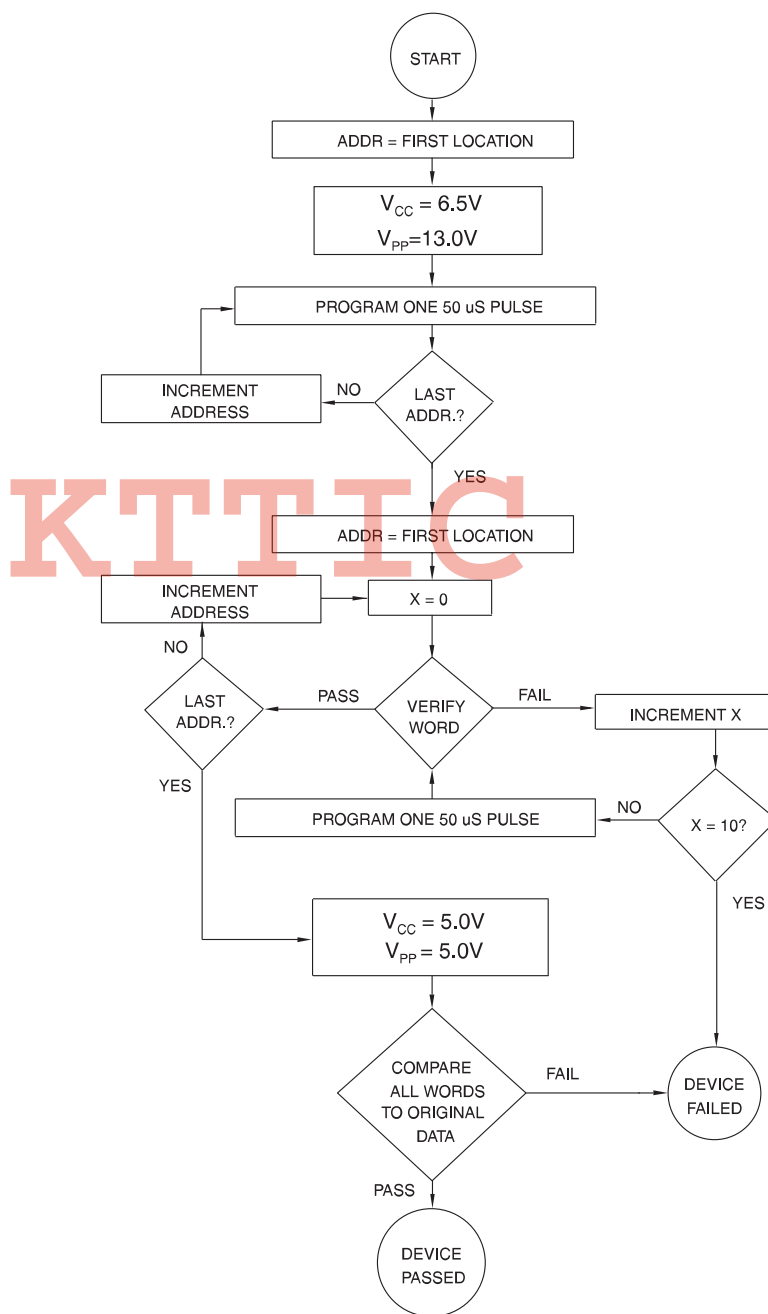

19. Ordering Information

19.1 Standard Package

t _{ACC} (ns)	I _{CC} (mA)		Ordering Code	Package	Operation Range
	Active	Standby			
55	40	0.1	AT27C4096-55JI AT27C4096-55PI AT27C4096-55VI	44J 40P6 40V ⁽¹⁾	Industrial (-40° C to 85° C)
90	40	0.1	AT27C4096-90JI AT27C4096-90PI AT27C4096-90VI	44J 40P6 40V ⁽¹⁾	Industrial (-40° C to 85° C)

Note: Not recommended for new designs. Use Green package option.

19.2 Green Package (Pb/Halide-free)

t _{ACC} (ns)	I _{CC} (mA)		Ordering Code	Package	Operation Range
	Active	Standby			
55	40	0.1	AT27C4096-55JU AT27C4096-55PU	44J 40P6	Industrial (-40° C to 85° C)
90	40	0.1	AT27C4096-90JU AT27C4096-90PU	44J 40P6	Industrial (-40° C to 85° C)

Note: 1. The 40-lead VSOP package is not recommended for new designs.

KTTIC

Package Type	
44J	44-lead, Plastic J-Leaded Chip Carrier (PLCC)
40P6	40-lead, 0.600" Wide, Plastic Dual Inline Package (PDIP)
40V	40-lead, Plastic Thin Small Outline Package (VSOP)

20. Packaging Information

20.1 44J – PLCC

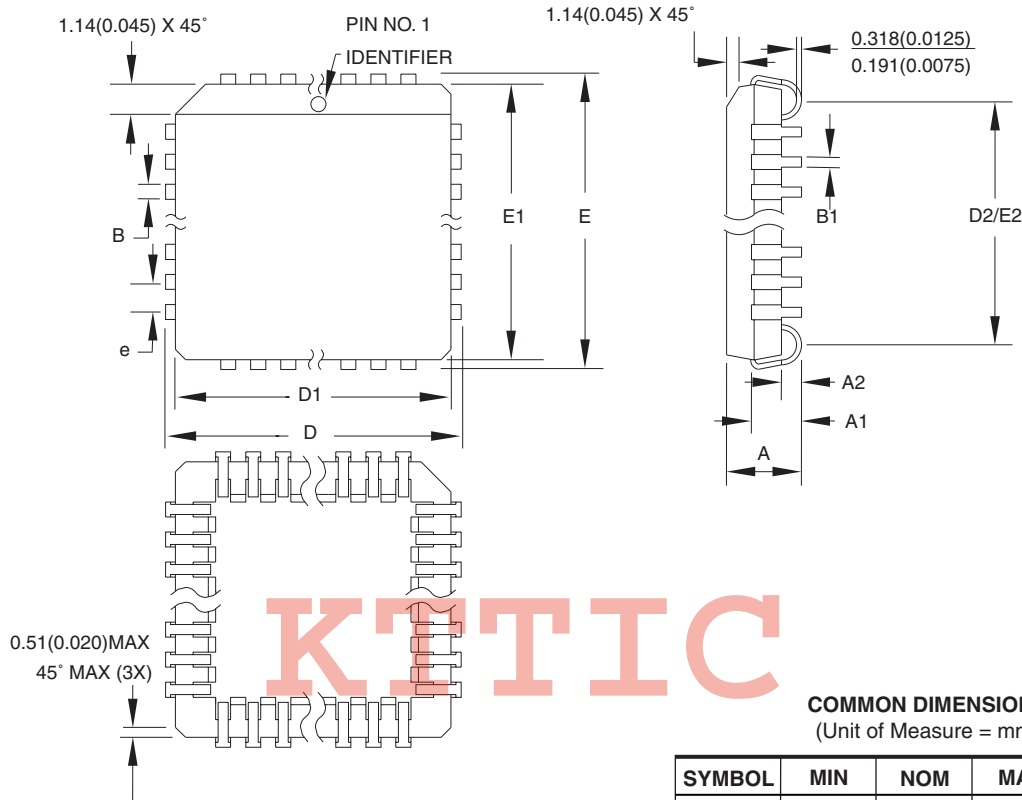

COMMON DIMENSIONS
(Unit of Measure = mm)

SYMBOL	MIN	NOM	MAX	NOTE
A	4.191	-	4.572	
A1	2.286	-	3.048	
A2	0.508	-	-	
D	17.399	-	17.653	
D1	16.510	-	16.662	Note 2
E	17.399	-	17.653	
E1	16.510	-	16.662	Note 2
D2/E2	14.986	-	16.002	
B	0.660	-	0.813	
B1	0.330	-	0.533	
e	1.270 TYP			

- Notes:
1. This package conforms to JEDEC reference MS-018, Variation AC.
 2. Dimensions D1 and E1 do not include mold protrusion. Allowable protrusion is .010"(0.254 mm) per side. Dimension D1 and E1 include mold mismatch and are measured at the extreme material condition at the upper or lower parting line.
 3. Lead coplanarity is 0.004" (0.102 mm) maximum.

10/04/01



2325 Orchard Parkway
San Jose, CA 95131

TITLE

44J, 44-lead, Plastic J-leaded Chip Carrier (PLCC)

DRAWING NO.

44J

REV.

B





20.2 40P6 – PDIP

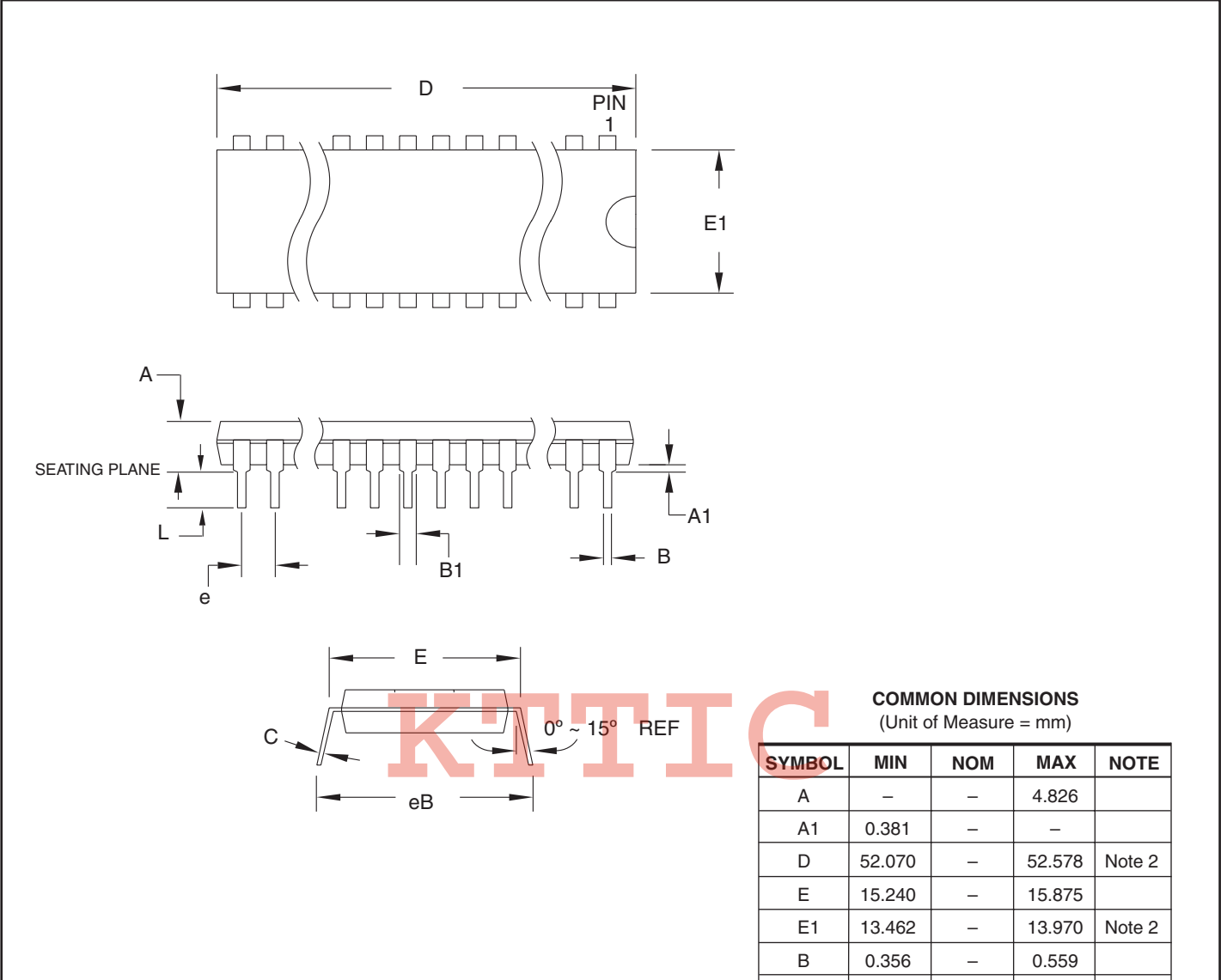

COMMON DIMENSIONS
(Unit of Measure = mm)

SYMBOL	MIN	NOM	MAX	NOTE
A	-	-	4.826	
A1	0.381	-	-	
D	52.070	-	52.578	Note 2
E	15.240	-	15.875	
E1	13.462	-	13.970	Note 2
B	0.356	-	0.559	
B1	1.041	-	1.651	
L	3.048	-	3.556	
C	0.203	-	0.381	
eB	15.494	-	17.526	
e	2.540 TYP			

Notes: 1. This package conforms to JEDEC reference MS-011, Variation AC.
2. Dimensions D and E1 do not include mold Flash or Protrusion.
Mold Flash or Protrusion shall not exceed 0.25 mm (0.010").

09/28/01

 2325 Orchard Parkway San Jose, CA 95131	TITLE 40P6 , 40-lead (0.600"/15.24 mm Wide) Plastic Dual Inline Package (PDIP)	DRAWING NO.	REV.
		40P6	B

20.3 40V – VSOP

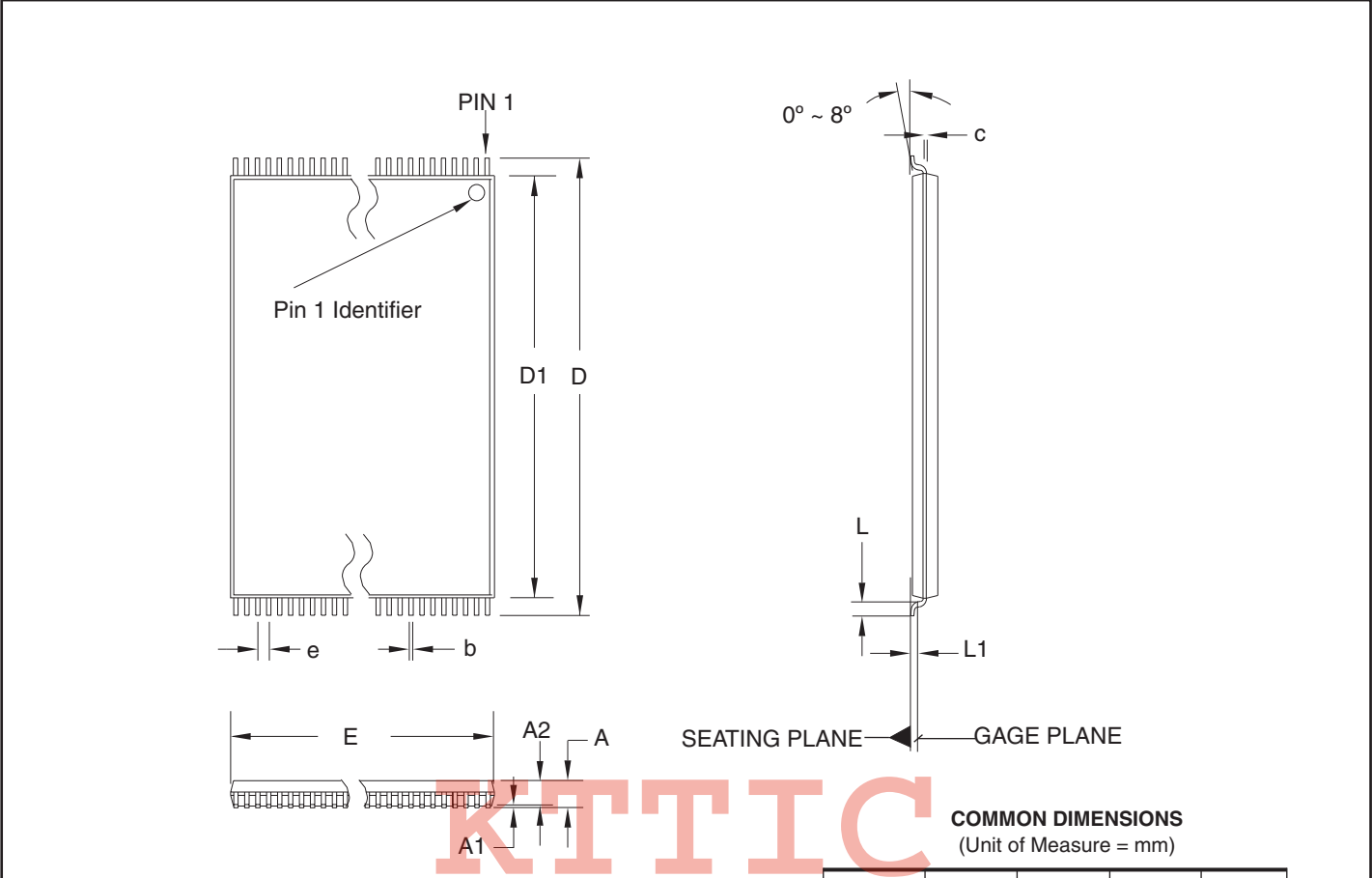

KTTIC

COMMON DIMENSIONS
(Unit of Measure = mm)

SYMBOL	MIN	NOM	MAX	NOTE
A	–	–	1.20	
A1	0.05	–	0.15	
A2	0.95	1.00	1.05	
D	13.80	14.00	14.20	
D1	12.30	12.40	12.50	Note 2
E	9.90	10.00	10.10	Note 2
L	0.50	0.60	0.70	
L1	0.25 BASIC			
b	0.17	0.22	0.27	
c	0.10	–	0.21	
e	0.50 BASIC			

- Notes:
1. This package conforms to JEDEC reference MO-142, Variation CA.
 2. Dimensions D1 and E do not include mold protrusion. Allowable protrusion on E is 0.15 mm per side and on D1 is 0.25 mm per side.
 3. Lead coplanarity is 0.10 mm maximum.

10/18/01

 2325 Orchard Parkway San Jose, CA 95131	TITLE	DRAWING NO.	REV.
	40V, 40-lead (10 x 14 mm Package) Plastic Thin Small Outline Package, Type I (VSOP)	40V	B