

Features

- Fast Read Access Time – 90 ns
- Dual Voltage Range Operation
 - Unregulated Battery Power Supply Range, 2.7V to 3.6V or Standard 5V \pm 10% Supply Range
- Compatible with JEDEC Standard AT27C010
- Low Power CMOS Operation
 - 20 μ A Max (Less than 1 μ A Typical) Standby for $V_{CC} = 3.6V$
 - 29 mW Max Active at 5 MHz for $V_{CC} = 3.6V$
- JEDEC Standard Packages
 - 32-lead PLCC
 - 32-lead TSOP
 - 32-lead VSOP
- High Reliability CMOS Technology
 - 2,000V ESD Protection
 - 200 mA Latchup Immunity
- Rapid Programming Algorithm – 100 μ s/Byte (Typical)
- CMOS and TTL Compatible Inputs and Outputs
 - JEDEC Standard for LVTTTL and LVBO
- Integrated Product Identification Code
- Industrial Temperature Range
- Green (Pb/Halide-free) Packaging Option

1. Description

The AT27BV010 is a high-performance, low-power, low-voltage 1,048,576-bit one-time programmable read-only memory (OTP EPROM) organized as 128K by 8 bits. It requires only one supply in the range of 2.7V to 3.6V in normal read mode operation, making it ideal for fast, portable systems using either regulated or unregulated battery power.

Atmel's innovative design techniques provide fast speeds that rival 5V parts while keeping the low power consumption of a 3V supply. At $V_{CC} = 2.7V$, any byte can be accessed in less than 90 ns. With a typical power draw of only 18 mW at 5 MHz and $V_{CC} = 3V$, the AT27BV010 consumes less than one fifth the power of a standard 5V EPROM. Standby mode supply current is typically less than 1 μ A at 3V. The AT27BV010 simplifies system design and stretches battery lifetime even further by eliminating the need for power supply regulation.

The AT27BV010 is available in industry-standard JEDEC-approved one-time programmable (OTP) plastic PLCC, TSOP, and VSOP packages. All devices feature two-line control (\overline{CE} , \overline{OE}) to give designers the flexibility to prevent bus contention.

The AT27BV010 operating with V_{CC} at 3.0V produces TTL level outputs that are compatible with standard TTL logic devices operating at $V_{CC} = 5.0V$. At $V_{CC} = 2.7V$, the part is compatible with JEDEC approved low voltage battery operation (LVBO) interface specifications. The device is also capable of standard 5-volt operation making it ideally suited for dual supply range systems or card products that are pluggable in both 3-volt and 5-volt hosts.



**1-Megabit
(128K x 8)
Unregulated
Battery-Voltage
OTP EPROM**

AT27BV010

0344H-EPROM-12/07



Atmel's AT27BV010 has additional features to ensure high quality and efficient production use. The Rapid Programming Algorithm reduces the time required to program the part and guarantees reliable programming. Programming time is typically only 100 μ s/byte. The Integrated Product Identification Code electronically identifies the device and manufacturer. This feature is used by industry-standard programming equipment to select the proper programming algorithms and voltages. The AT27BV010 programs exactly the same way as a standard 5V AT27C010 and uses the same programming equipment.

2. Pin Configurations

Pin Name	Function
A0 - A16	Addresses
O0 - O7	Outputs
\overline{CE}	Chip Enable
\overline{OE}	Output Enable
\overline{PGM}	Program Strobe
NC	No Connect

2.1 32-lead TSOP/VSOP (Type 1) Top View

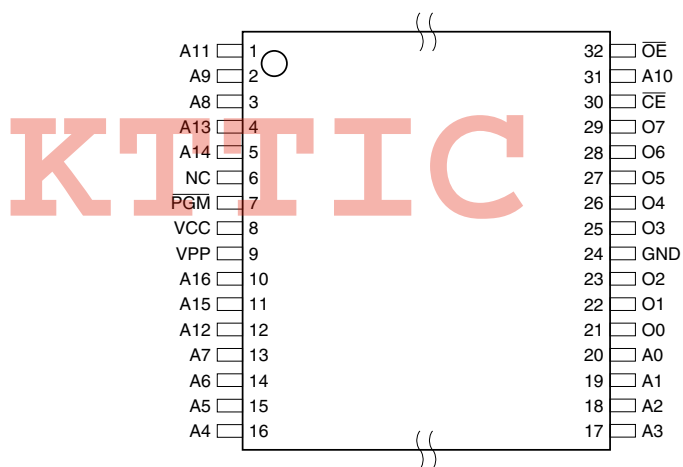

2.2 32-lead PLCC Top View

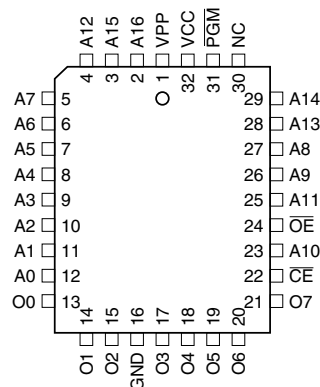

3. System Considerations

Switching between active and standby conditions via the Chip Enable pin may produce transient voltage excursions. Unless accommodated by the system design, these transients may exceed datasheet limits, resulting in device non-conformance. At a minimum, a 0.1 μF high frequency, low inherent inductance, ceramic capacitor should be utilized for each device. This capacitor should be connected between the V_{CC} and Ground terminals of the device, as close to the device as possible. Additionally, to stabilize the supply voltage level on printed circuit boards with large EPROM arrays, a 4.7 μF bulk electrolytic capacitor should be utilized, again connected between the V_{CC} and Ground terminals. This capacitor should be positioned as close as possible to the point where the power supply is connected to the array.

4. Block Diagram

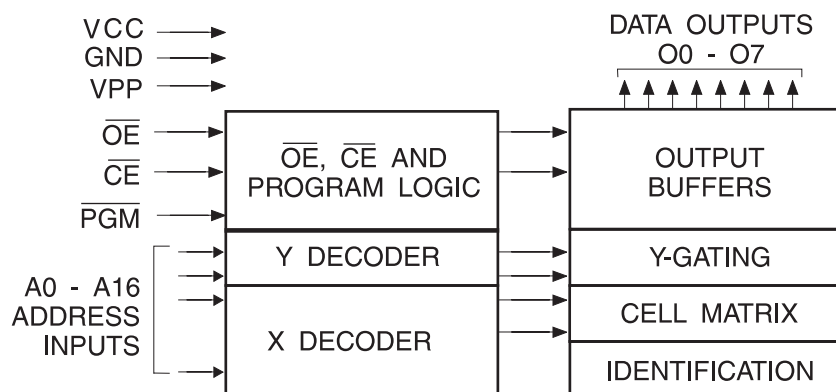

5. Absolute Maximum Ratings*

Temperature Under Bias.....	-40°C to +85°C
Storage Temperature.....	-65°C to +125°C
Voltage on Any Pin with Respect to Ground.....	-2.0V to +7.0V ⁽¹⁾
Voltage on A9 with Respect to Ground.....	-2.0V to +14.0V ⁽¹⁾
V_{PP} Supply Voltage with Respect to Ground.....	-2.0V to +14.0V ⁽¹⁾

*NOTICE: Stresses beyond those listed under “Absolute Maximum Ratings” may cause permanent damage to the device. This is a stress rating only and functional operation of the device at these or any other conditions beyond those indicated in the operational sections of this specification is not implied. Exposure to absolute maximum rating conditions for extended periods may affect device reliability

Note: 1. Minimum voltage is -0.6V DC which may undershoot to -2.0V for pulses of less than 20 ns. Maximum output pin voltage is $V_{CC} + 0.75V$ DC which may be exceeded if certain precautions are observed (consult application notes) and which may overshoot to +7.0V for pulses of less than 20 ns.

6. Operating Modes

Mode/Pin	\overline{CE}	\overline{OE}	\overline{PGM}	Ai	V _{PP}	V _{CC}	Outputs
Read ⁽²⁾	V _{IL}	V _{IL}	X ⁽¹⁾	Ai	X	V _{CC}	D _{OUT}
Output Disable ⁽²⁾	X	V _{IH}	X	X	X	V _{CC}	High Z
Standby ⁽²⁾	V _{IH}	X	X	X	X	V _{CC}	High Z
Rapid Program ⁽³⁾	V _{IL}	V _{IH}	V _{IL}	Ai	V _{PP}	V _{CC}	D _{IN}
PGM Verify ⁽³⁾	V _{IL}	V _{IL}	V _{IH}	Ai	V _{PP}	V _{CC}	D _{OUT}
PGM Inhibit ⁽³⁾	V _{IH}	X	X	X	V _{PP}	V _{CC}	High Z
Product Identification ⁽³⁾⁽⁵⁾	V _{IL}	V _{IL}	X	A9 = V _H ⁽⁴⁾ A0 = V _{IH} or V _{IL} A1 - A16 = V _{IL}	X	V _{CC}	Identification Code

- Notes:
1. X can be V_{IL} or V_{IH}.
 2. Read, output disable, and standby modes require, 2.7V ≤ V_{CC} ≤ 3.6V, or 4.5V ≤ V_{CC} ≤ 5.5V.
 3. Refer to Programming Characteristics. Programming modes require V_{CC} = 6.5V.
 4. V_H = 12.0 ± 0.5V.
 5. Two identifier bytes may be selected. All Ai inputs are held low (V_{IL}), except A9 which is set to V_H and A0 which is toggled low (V_{IL}) to select the Manufacturer's Identification byte and high (V_{IH}) to select the Device Code byte.

7. DC and AC Operating Conditions for Read Operation

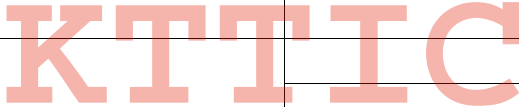
		AT27BV010-90
Industrial Operating Temperature (Case)		-40°C - 85°C
V _{CC} Power Supply		2.7V to 3.6V
		5V ± 10%

8. DC and Operating Characteristics for Read Operation

Symbol	Parameter	Condition	Min	Max	Units
V_{CC} = 2.7V to 3.6V					
I _{LI}	Input Load Current	V _{IN} = 0V to V _{CC}		±1	μA
I _{LO}	Output Leakage Current	V _{OUT} = 0V to V _{CC}		±5	μA
I _{PP1} ⁽²⁾	V _{PP} ⁽¹⁾ Read/Standby Current	V _{PP} = V _{CC}		10	μA
I _{SB}	V _{CC} ⁽¹⁾ Standby Current	I _{SB1} (CMOS), $\overline{CE} = V_{CC} \pm 0.3V$		20	μA
		I _{SB2} (TTL), $\overline{CE} = 2.0$ to V _{CC} + 0.5V		100	μA
I _{CC}	V _{CC} Active Current	f = 5 MHz, I _{OUT} = 0 mA, $\overline{CE} = V_{IL}$, V _{CC} = 3.6V		8	mA
V _{IL}	Input Low Voltage	V _{CC} = 3.0 to 3.6V	-0.6	0.8	V
		V _{CC} = 2.7 to 3.6V	-0.6	0.2 x V _{CC}	V
V _{IH}	Input High Voltage	V _{CC} = 3.0 to 3.6V	2.0	V _{CC} + 0.5	V
		V _{CC} = 2.7 to 3.6V	0.7 x V _{CC}	V _{CC} + 0.5	V
V _{OL}	Output Low Voltage	I _{OL} = 2.0 mA		0.4	V
		I _{OL} = 100 μA		0.2	V
		I _{OL} = 20 μA		0.1	V
V _{OH}	Output High Voltage	I _{OH} = -2.0 mA	2.4		V
		I _{OH} = -100 μA	V _{CC} - 0.2		V
		I _{OH} = -20 μA	V _{CC} - 0.1		V
V_{CC} = 4.5V to 5.5V					
I _{LI}	Input Load Current	V _{IN} = 0V to V _{CC}		±1	μA
I _{LO}	Output Leakage Current	V _{OUT} = 0V to V _{CC}		±5	μA
I _{PP1} ⁽²⁾	V _{PP} ⁽¹⁾ Read/Standby Current	V _{PP} = V _{CC}		10	μA
I _{SB}	V _{CC} ⁽¹⁾ Standby Current	I _{SB1} (CMOS), $\overline{CE} = V_{CC} \pm 0.3V$		100	μA
		I _{SB2} (TTL), $\overline{CE} = 2.0$ to V _{CC} + 0.5V		1	mA
I _{CC}	V _{CC} Active Current	f = 5 MHz, I _{OUT} = 0 mA, $\overline{CE} = V_{IL}$		25	mA
V _{IL}	Input Low Voltage		-0.6	0.8	V
V _{IH}	Input High Voltage		2.0	V _{CC} + 0.5	V
V _{OL}	Output Low Voltage	I _{OL} = 2.1 mA		0.4	V
V _{OH}	Output High Voltage	I _{OH} = -400 μA	2.4		V

- Notes: 1. V_{CC} must be applied simultaneously with or before V_{PP}, and removed simultaneously with or after V_{PP}.
 2. V_{PP} may be connected directly to V_{CC}, except during programming. The supply current would then be the sum of I_{CC} and I_{PP}.

9. AC Characteristics for Read Operation

$V_{CC} = 2.7V$ to $3.6V$ and $4.5V$ to $5.5V$

Symbol	Parameter	Condition	-90		Units
			Min	Max	
$t_{ACC}^{(3)}$	Address to Output Delay	$\overline{CE} = \overline{OE} = V_{IL}$		90	ns
$t_{CE}^{(2)}$	\overline{CE} to Output Delay	$\overline{OE} = V_{IL}$		90	ns
$t_{OE}^{(2)(3)}$	\overline{OE} to Output Delay	$\overline{CE} = V_{IL}$		50	ns
$t_{DF}^{(4)(5)}$	\overline{OE} or \overline{CE} High to Output Float, Whichever Occurred First			40	ns
t_{OH}	Output Hold from Address, \overline{CE} or \overline{OE} , Whichever Occurred First		0		ns

10. AC Waveforms for Read Operation⁽¹⁾

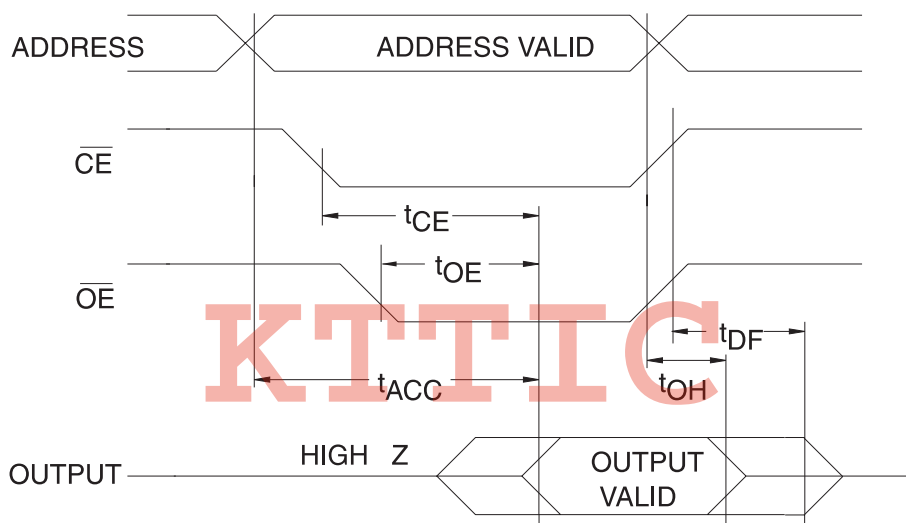

- Notes:
1. Timing measurement references are 0.8V and 2.0V. Input AC drive levels are 0.45V and 2.4V, unless otherwise specified.
 2. \overline{OE} may be delayed up to $t_{CE} - t_{OE}$ after the falling edge of \overline{CE} without impact on t_{CE} .
 3. \overline{OE} may be delayed up to $t_{ACC} - t_{OE}$ after the address is valid without impact on t_{ACC} .
 4. This parameter is only sampled and is not 100% tested.
 5. Output float is defined as the point when data is no longer driven.

11. Input Test Waveform and Measurement Level

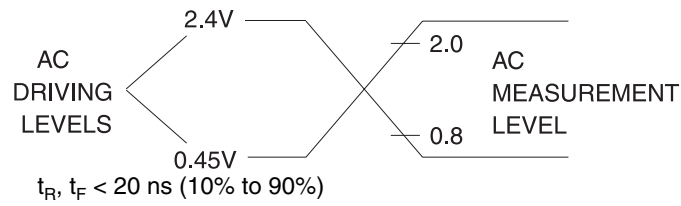

12. Output Test Load

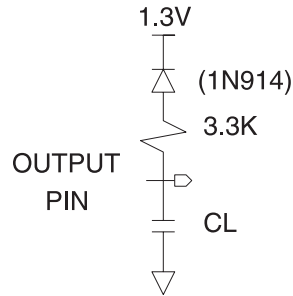

Note: CL = 100 pF including jig capacitance.

13. Pin Capacitance

f = 1 MHz, T = 25°C⁽¹⁾

Symbol	Typ	Max	Units	Conditions
C _{IN}	4	8	pF	V _{IN} = 0V
C _{OUT}	8	12	pF	V _{OUT} = 0V

Note: 1. Typical values for nominal supply voltage. This parameter is only sampled and is not 100% tested.

14. Programming Waveforms⁽¹⁾

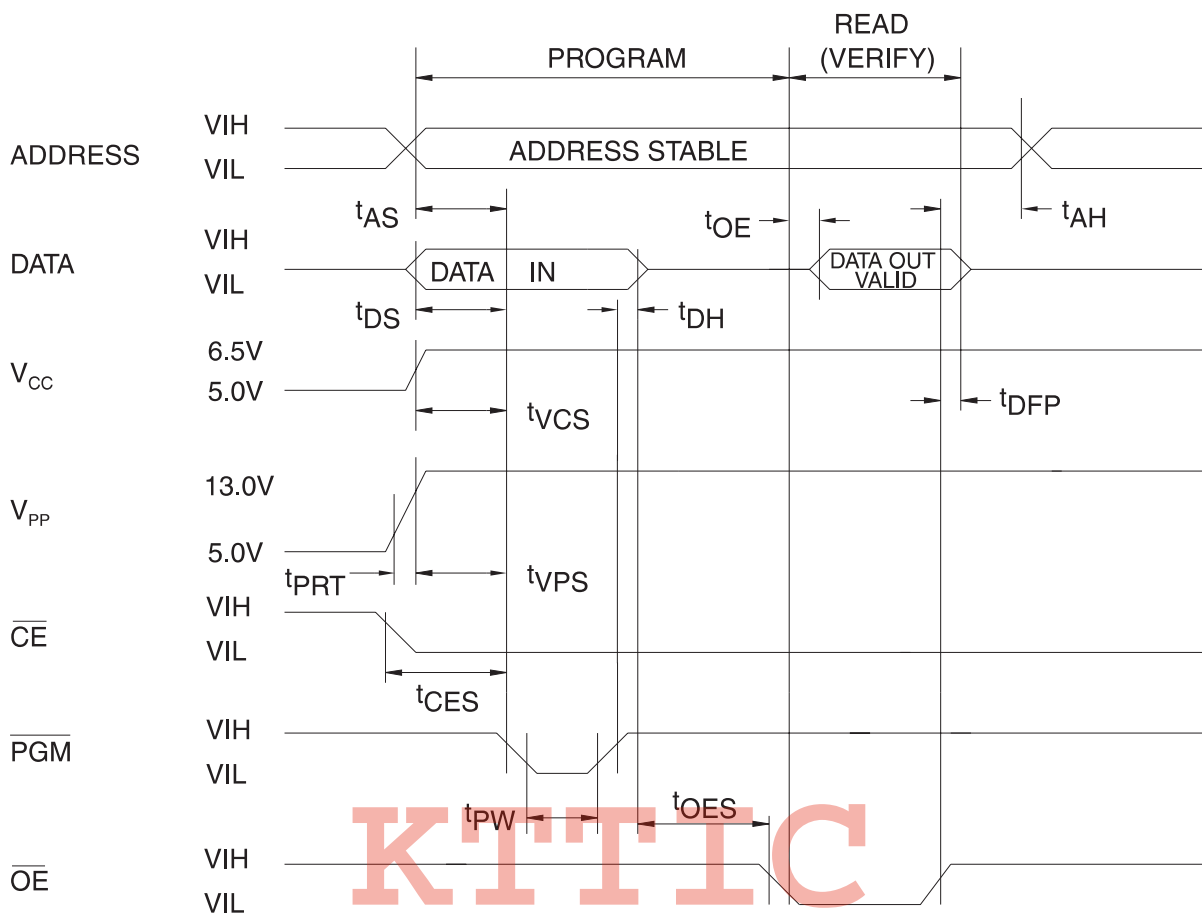

- Notes:
1. The Input Timing Reference is 0.8V for V_{IL} and 2.0V for V_{IH}.
 2. t_{OE} and t_{DFP} are characteristics of the device but must be accommodated by the programmer.
 3. When programming the AT27BV010, a 0.1 μF capacitor is required across V_{PP} and ground to suppress spurious voltage transients.

15. DC Programming Characteristics

$T_A = 25 \pm 5^\circ\text{C}$, $V_{CC} = 6.5 \pm 0.25\text{V}$, $V_{PP} = 13.0 \pm 0.25\text{V}$

Symbol	Parameter	Test Conditions	Limits		Units
			Min	Max	
I_{LI}	Input Load Current	$V_{IN} = V_{IL}, V_{IH}$		± 10	μA
V_{IL}	Input Low Level		-0.6	0.8	V
V_{IH}	Input High Level		2.0	$V_{CC} + 1$	V
V_{OL}	Output Low Voltage	$I_{OL} = 2.1 \text{ mA}$		0.4	V
V_{OH}	Output High Voltage	$I_{OH} = -400 \mu\text{A}$	2.4		V
I_{CC2}	V_{CC} Supply Current (Program and Verify)			40	mA
I_{PP2}	V_{PP} Supply Current	$\overline{CE} = \overline{PGM} = V_{IL}$		20	mA
V_{ID}	A9 Product Identification Voltage		11.5	12.5	V

16. AC Programming Characteristics

$T_A = 25 \pm 5^\circ\text{C}$, $V_{CC} = 6.5 \pm 0.25\text{V}$, $V_{PP} = 13.0 \pm 0.2\text{V}$

Symbol	Parameter	Test Conditions ⁽¹⁾	Limits		Units
			Min	Max	
t_{AS}	Address Setup Time	Input Rise and Fall Times: (10% to 90%) 20 ns Input Pulse Levels: 0.45V to 2.4V Input Timing Reference Level: 0.8V to 2.0V Output Timing Reference Level: 0.8V to 2.0V	2		μs
t_{CES}	\overline{CE} Setup Time		2		μs
t_{OES}	\overline{OE} Setup Time		2		μs
t_{DS}	Data Setup Time		2		μs
t_{AH}	Address Hold Time		0		μs
t_{DH}	Data Hold Time		2		μs
t_{DFP}	\overline{OE} High to Output Float Delay ⁽²⁾		0	130	ns
t_{VPS}	V_{PP} Setup Time		2		μs
t_{VCS}	V_{CC} Setup Time		2		μs
t_{PW}	\overline{PGM} Program Pulse Width ⁽³⁾		95	105	μs
t_{OE}	Data Valid from \overline{OE}		150	ns	
t_{PRT}	V_{PP} Pulse Rise Time During Programming	50		ns	

- Notes:
- V_{CC} must be applied simultaneously or before V_{PP} and removed simultaneously or after V_{PP}
 - This parameter is only sampled and is not 100% tested. Output Float is defined as the point where data is no longer driven – see timing diagram.
 - Program Pulse width tolerance is 100 $\mu\text{sec} \pm 5\%$.

17. Atmel's AT27BV010 Integrated Product Identification Code⁽¹⁾

Codes	Pins									Hex Data
	A0	O7	O6	O5	O4	O3	O2	O1	O0	
Manufacturer	0	0	0	0	1	1	1	1	0	1E
Device Type	1	0	0	0	0	0	1	0	1	05

Note: 1. The AT27BV010 has the same Product Identification Code as the AT27C010. Both are programming compatible.

18. Rapid Programming Algorithm

A 100 μs $\overline{\text{PGM}}$ pulse width is used to program. The address is set to the first location. V_{CC} is raised to 6.5V and V_{PP} is raised to 13.0V. Each address is first programmed with one 100 μs $\overline{\text{PGM}}$ pulse without verification. Then a verification/reprogramming loop is executed for each address. In the event a byte fails to pass verification, up to 10 successive 100 μs pulses are applied with a verification after each pulse. If the byte fails to verify after 10 pulses have been applied, the part is considered failed. After the byte verifies properly, the next address is selected until all have been checked. V_{PP} is then lowered to 5.0V and V_{CC} to 5.0V. All bytes are read again and compared with the original data to determine if the device passes or fails.

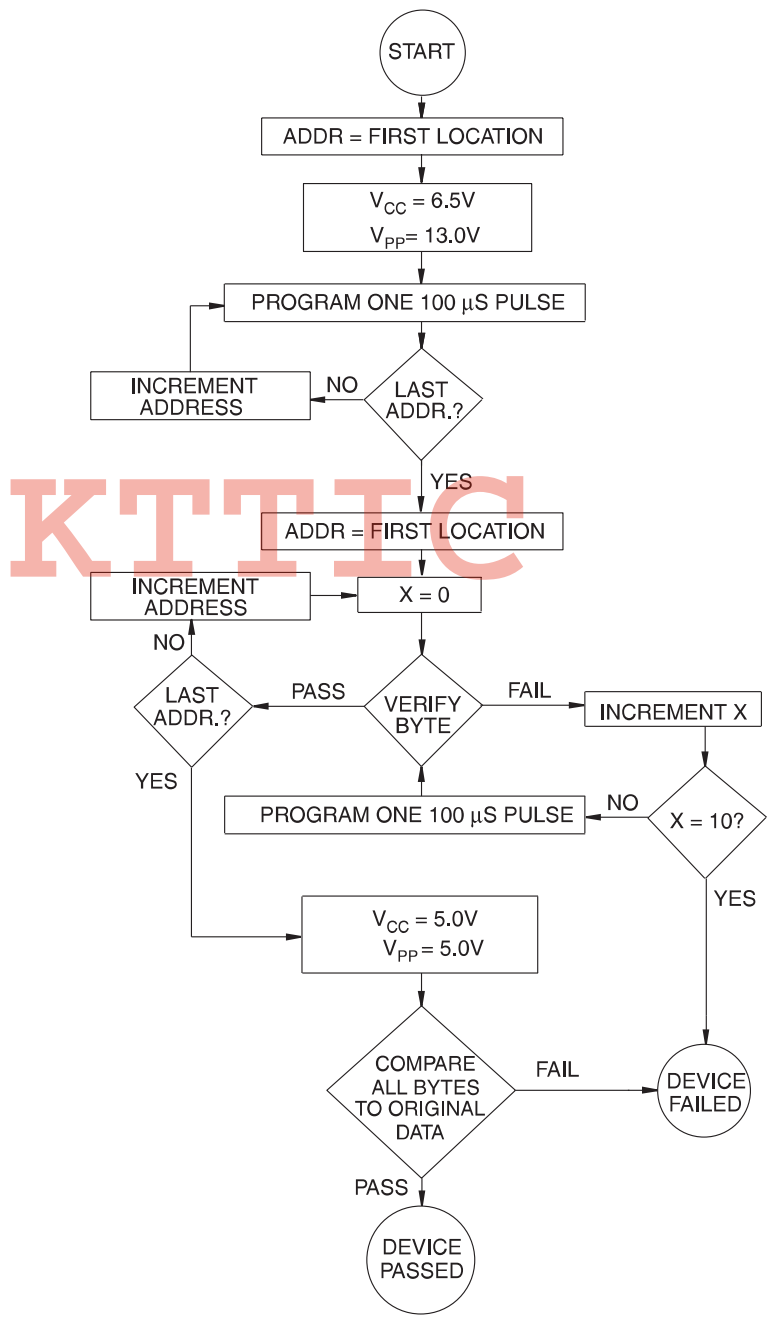

19. Ordering Information

19.1 Standard Package

t _{ACC} (ns)	I _{CC} (mA) V _{CC} = 3.6V		Ordering Code	Package	Operation Range
	Active	Standby			
90	8	0.02	AT27BV010-90JI AT27BV010-90TI AT27BV010-90VI	32J 32T 32V ⁽¹⁾	Industrial (-40°C to 85°C)

Note: Not recommended for new designs. Use Green package option.

19.2 Green Package (Pb/Halide-free)

t _{ACC} (ns)	I _{CC} (mA) V _{CC} = 3.6V		Ordering Code	Package	Operation Range
	Active	Standby			
90	8	0.02	AT27BV010-90JU AT27BV010-90TU	32J 32T	Industrial (-40°C to 85°C)

Note: 1. The 32-lead VSOP package is not recommended for new designs.

KTTIC

Package Type	
32J	32-lead, Plastic J-leded Chip Carrier (PLCC)
32T	32-lead, Plastic Thin Small Outline Package (TSOP)
32V	33-lead, Plastic Thin Small Outline Package (VSOP)



20. Packaging Information

20.1 32J – PLCC

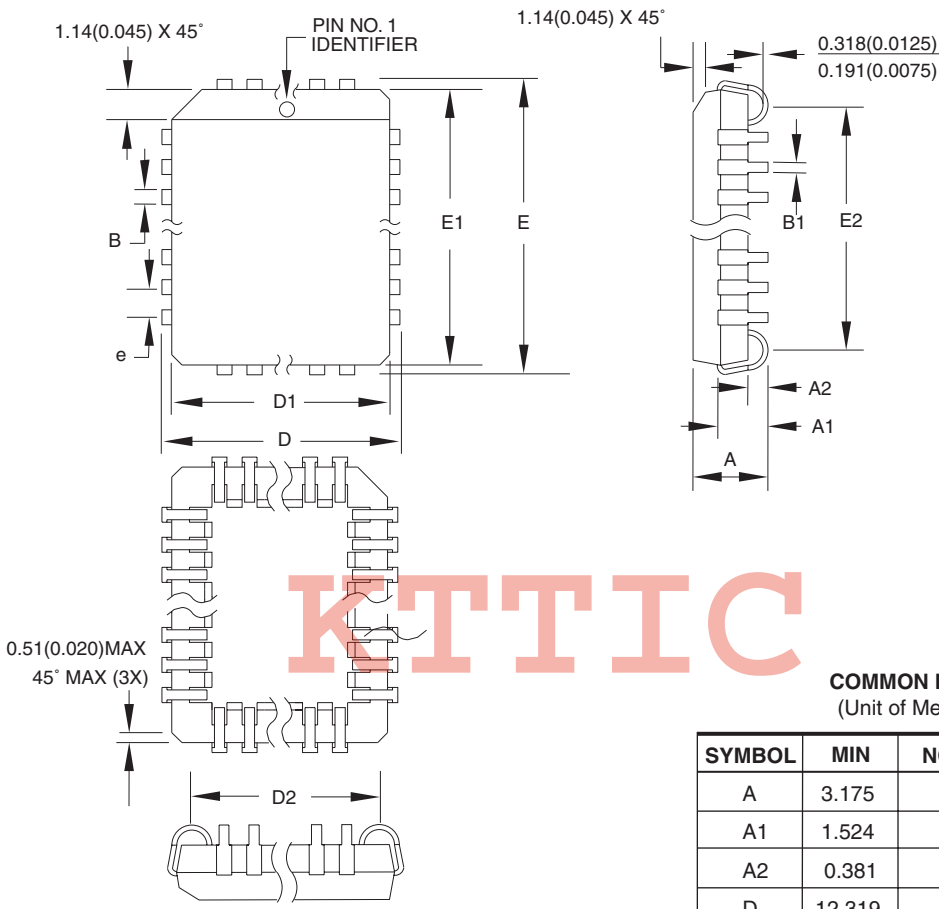

KTTIC

COMMON DIMENSIONS
(Unit of Measure = mm)

SYMBOL	MIN	NOM	MAX	NOTE
A	3.175	-	3.556	
A1	1.524	-	2.413	
A2	0.381	-	-	
D	12.319	-	12.573	
D1	11.354	-	11.506	Note 2
D2	9.906	-	10.922	
E	14.859	-	15.113	
E1	13.894	-	14.046	Note 2
E2	12.471	-	13.487	
B	0.660	-	0.813	
B1	0.330	-	0.533	
e	1.270 TYP			

- Notes:
1. This package conforms to JEDEC reference MS-016, Variation AE.
 2. Dimensions D1 and E1 do not include mold protrusion. Allowable protrusion is .010" (0.254 mm) per side. Dimension D1 and E1 include mold mismatch and are measured at the extreme material condition at the upper or lower parting line.
 3. Lead coplanarity is 0.004" (0.102 mm) maximum.

10/04/01

 2325 Orchard Parkway San Jose, CA 95131	TITLE	DRAWING NO.	REV.
	32J, 32-lead, Plastic J-leaded Chip Carrier (PLCC)	32J	B

20.2 32T – TSOP

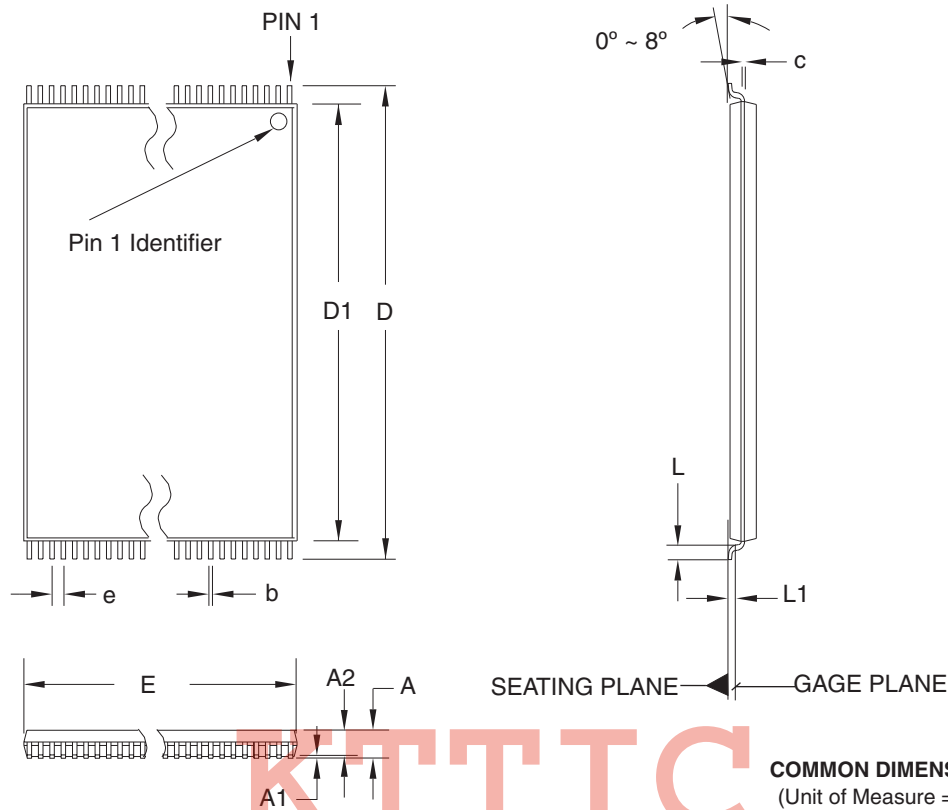

COMMON DIMENSIONS
(Unit of Measure = mm)

SYMBOL	MIN	NOM	MAX	NOTE
A	–	–	1.20	
A1	0.05	–	0.15	
A2	0.95	1.00	1.05	
D	19.80	20.00	20.20	
D1	18.30	18.40	18.50	Note 2
E	7.90	8.00	8.10	Note 2
L	0.50	0.60	0.70	
L1	0.25 BASIC			
b	0.17	0.22	0.27	
c	0.10	–	0.21	
e	0.50 BASIC			

- Notes:
1. This package conforms to JEDEC reference MO-142, Variation BD.
 2. Dimensions D1 and E do not include mold protrusion. Allowable protrusion on E is 0.15 mm per side and on D1 is 0.25 mm per side.
 3. Lead coplanarity is 0.10 mm maximum.

10/18/01



2325 Orchard Parkway
San Jose, CA 95131

TITLE

32T, 32-lead (8 x 20 mm Package) Plastic Thin Small Outline Package, Type I (TSOP)

DRAWING NO.

32T

REV.

B





20.3 32V – VSOP

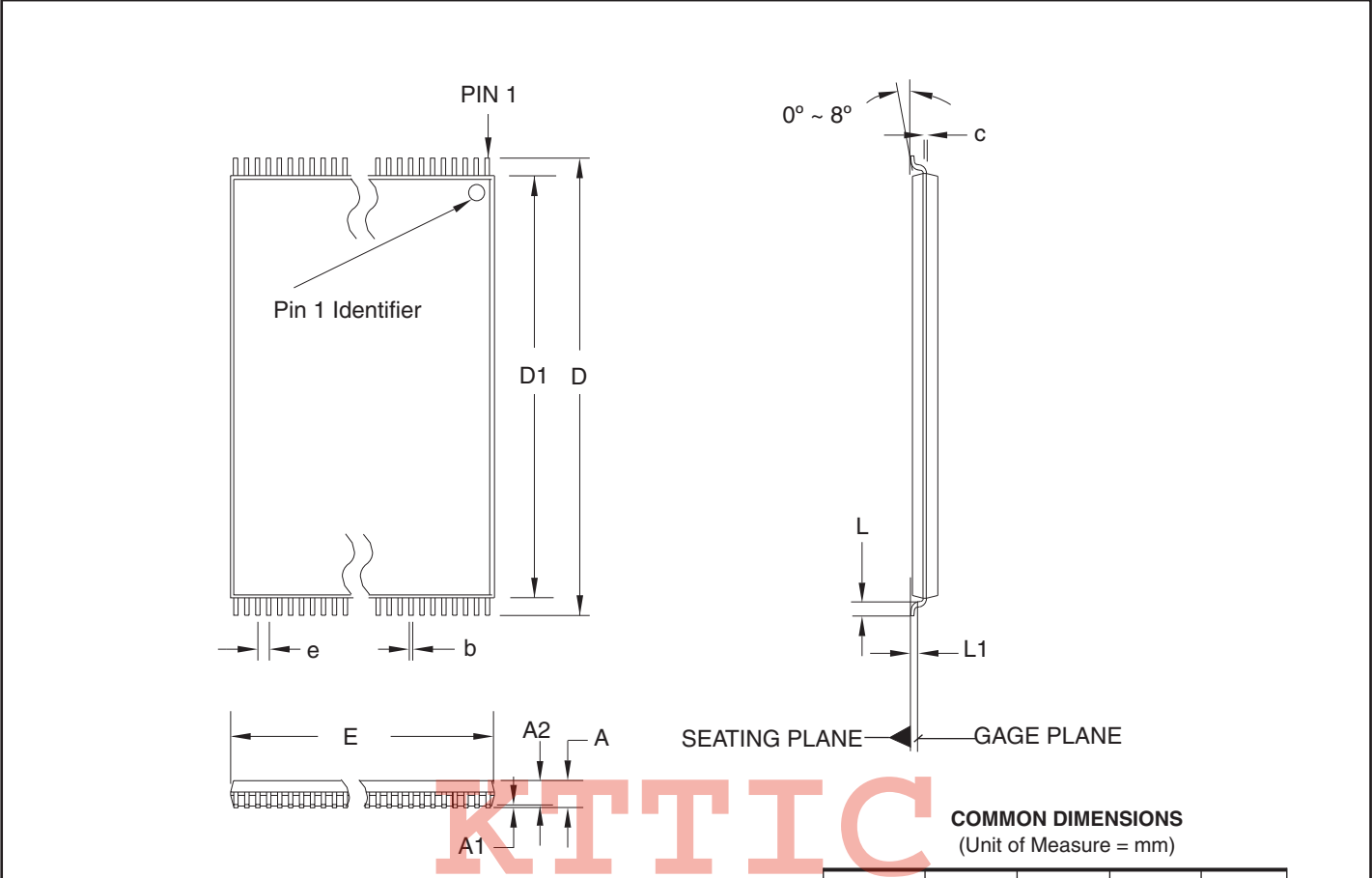

KTTIC

COMMON DIMENSIONS
(Unit of Measure = mm)

SYMBOL	MIN	NOM	MAX	NOTE
A	–	–	1.20	
A1	0.05	–	0.15	
A2	0.95	1.00	1.05	
D	13.80	14.00	14.20	
D1	12.30	12.40	12.50	Note 2
E	7.90	8.00	8.10	Note 2
L	0.50	0.60	0.70	
L1	0.25 BASIC			
b	0.17	0.22	0.27	
c	0.10	–	0.21	
e	0.50 BASIC			

- Notes:
1. This package conforms to JEDEC reference MO-142, Variation BA.
 2. Dimensions D1 and E do not include mold protrusion. Allowable protrusion on E is 0.15 mm per side and on D1 is 0.25 mm per side.
 3. Lead coplanarity is 0.10 mm maximum.

10/18/01

 2325 Orchard Parkway San Jose, CA 95131	TITLE	DRAWING NO.	REV.
	32V, 32-lead (8 x 14 mm Package) Plastic Thin Small Outline Package, Type I (VSOP)	32V	B