

Advanced Monolithic Systems

AMS1508

8A LOW DROPOUT VOLTAGE REGULATORS

RoHS compliant

FEATURES

- Adjustable or Fixed Output
1.5V, 2.5V, 2.85V, 3.0V, 3.3V, 3.5V and 5.0V
- Output Current of 10A
- Low Dropout, 500mV at 10A Output Current
- Fast Transient Response
- Remote Sense

APPLICATIONS

- High Current Regulators
- Post Regulators for Switching Supplies
- Microprocessor Supply
- Adjustable Power Supply
- Notebook/Personal Computer Supplies

GENERAL DESCRIPTION

The AMS1508 series of adjustable and fixed low dropout voltage regulators are designed to provide 8A output current to power the new generation of microprocessors. The dropout voltage of the device is 100mV at light loads and rising to 500mV at maximum output current. A second low current input voltage 1V or greater than the output voltage is required to achieve this dropout. The AMS1508 can also be used as a single supply device.

New features have been added to the AMS1508: a remote Sense pin is brought out virtually eliminating output voltage variations due to load changes. The typical load regulation, measured at the Sense pin, for a load current step of 100mA to 8A is less than 1mV.

The AMS1508 series has fast transient response. The Adjust pin is brought out on fixed devices. To further improve the transient response the addition of a small capacitor on the Adjust pin is recommended.

The AMS1508 series are ideal for generating processor supplies of 2V to 3V on motherboards where both 5V and 3.3V supplies are available.

The AMS1508 devices are offered in 5 lead TO-220 and TO-263 (plastic DD) packages.

ORDERING INFORMATION:

PACKAGE TYPE		OPERATING JUNCTION TEMPERATURE RANGE
5 LEAD TO-263	5 LEAD TO-220	
AMS1508CM	AMS1508CT	0 to 125° C
AMS1508CM-1.5	AMS1508CT-1.5	0 to 125° C
AMS1508CM-2.5	AMS1508CT-2.5	0 to 125° C
AMS1508CM-2.85	AMS1508CT-2.85	0 to 125° C
AMS1508CM-3.0	AMS1508CT-3.0	0 to 125° C
AMS1508CM-3.3	AMS1508CT-3.3	0 to 125° C
AMS1508CM-3.5	AMS1508CT-3.5	0 to 125° C
AMS1508CM-5.0	AMS1508CT-5.0	0 to 125° C

PIN CONNECTIONS

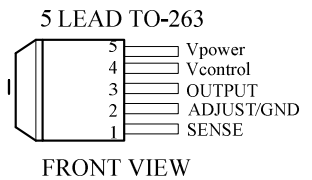
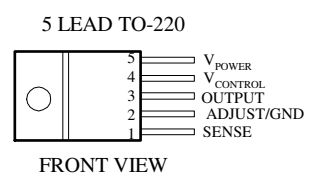

ABSOLUTE MAXIMUM RATINGS (Note 1)

V _{POWER} Input Voltage	7V	Soldering information	
V _{CONTROL} Input Voltage	13V	Lead Temperature (25 sec)	265°C
Operating Junction Temperature Range		Thermal Resistance	
Control Section	0°C to 125°C	TO-220 package	φ _{JA} = 50°C/W
Power Transistor	0°C to 150°C	TO-263 package	φ _{JA} = 30°C/W*
Storage temperature	- 65°C to +150°C	* With package soldering to 0.5in ² copper area over backside ground plane or internal power plane φ _{JA} can vary from 20°C/W to >40°C/W depending on mounting technique.	

ELECTRICAL CHARACTERISTICS

Electrical Characteristics at I_{LOAD} = 0 mA, and T_J = +25°C unless otherwise specified.

Parameter	Device	Conditions	Min	Typ	Max	Units
Reference Voltage	AMS1508	V _{CONTROL} = 2.75V, V _{POWER} = 2V, I _{LOAD} = 10mA V _{CONTROL} = 2.7V to 12V, V _{POWER} = 3.3V to 5.5V, I _{LOAD} = 10mA to 8A	1.243	1.250	1.258	V
			1.237	1.250	1.263	V
Output Voltage	AMS1508-1.5	V _{CONTROL} = 4V, V _{POWER} = 2V, I _{LOAD} = 0mA V _{CONTROL} = 3V, V _{POWER} = 2.3V, I _{LOAD} = 0mA to 8A	1.491	1.500	1.509	V
			1.485	1.500	1.515	V
	AMS1508-2.5	V _{CONTROL} = 5V, V _{POWER} = 3.3V, I _{LOAD} = 0mA V _{CONTROL} = 4V, V _{POWER} = 3.3V, I _{LOAD} = 0mA to 8A	2.485	2.500	2.515	V
			2.475	2.500	2.525	V
	AMS1508-2.85	V _{CONTROL} = 5.35V, V _{POWER} = 3.35V, I _{LOAD} = 0mA V _{CONTROL} = 4.4V, V _{POWER} = 3.7V, I _{LOAD} = 0mA to 8A	2.821	2.850	2.879	V
			2.833	2.850	2.867	V
	AMS1508-3.0	V _{CONTROL} = 5.5V, V _{POWER} = 3.5V, I _{LOAD} = 0mA V _{CONTROL} = 4.5V, V _{POWER} = 3.8V, I _{LOAD} = 0mA to 8A	2.982	3.000	3.018	V
			2.970	3.000	3.030	V
	AMS1508-3.3	V _{CONTROL} = 5.8V, V _{POWER} = 3.8V, I _{LOAD} = 0mA V _{CONTROL} = 4.8V, V _{POWER} = 4.1V, I _{LOAD} = 0mA to 8A	3.280	3.300	3.320	V
			3.235	3.300	3.333	V
	AMS1508-3.5	V _{CONTROL} = 6V, V _{POWER} = 4V, I _{LOAD} = 0mA V _{CONTROL} = 5V, V _{POWER} = 4.3V, I _{LOAD} = 0mA to 8A	3.479	3.500	3.521	V
			3.430	3.500	3.535	V
	AMS1508-5.0	V _{CONTROL} = 7.5V, V _{POWER} = 5.5V, I _{LOAD} = 0mA V _{CONTROL} = 6.5V, V _{POWER} = 5.8V, I _{LOAD} = 0mA to 8A	4.930	5.000	5.030	V
			4.950	5.000	5.050	V
Line Regulation	AMS1508/-1.5/-2.5/ -2.85/-3.0/-3.3/-3.5/-5.0	I _{LOAD} = 10 mA, 1.5V ≤ (V _{CONTROL} - V _{OUT}) ≤ 12V 0.8V ≤ (V _{POWER} - V _{OUT}) ≤ 5.5V		1	3	mV
Load Regulation	AMS1508/-1.5/-2.5/ -2.85/-3.0/-3.3/-3.5/-5.0	V _{CONTROL} = V _{OUT} + 2.5V, V _{POWER} = V _{OUT} + 0.8V, I _{LOAD} = 10mA to 8A		1	5	mV
Minimum Load Current	AMS1508	V _{CONTROL} = 5V, V _{POWER} = 3.3V, V _{ADJ} = 0V (Note 3)		5	10	mA
Control Pin Current (Note 4)	AMS1508/-1.5/-2.5/ -2.85/-3.0/-3.3/-3.5/-5.0	V _{CONTROL} = V _{OUT} + 2.5V, V _{POWER} = V _{OUT} + 0.8V, I _{LOAD} = 10mA to 8A		80	135	mA
Ground Pin Current (Note 4)	AMS1508/-1.5/-2.5/ -2.85/-3.0/-3.3/-3.5/-5.0	V _{CONTROL} = V _{OUT} + 2.5V, V _{POWER} = V _{OUT} + 0.8V, I _{LOAD} = 10mA to 8A		6	10	mA
Adjust Pin Current	AMS1508	V _{CONTROL} = 2.75V, V _{POWER} = 2.05V, I _{LOAD} = 10mA		50	120	μA
Current Limit	AMS1508/-1.5/-2.5/ -2.85/-3.0/-3.3/-3.5/-5.0	(V _{IN} - V _{OUT}) = 5V	7.1	8.0		A
Ripple Rejection	AMS1508/-1.5/-2.5/ -2.85/-3.0/-3.3/-3.5/-5.0	V _{CONTROL} = V _{POWER} = V _{OUT} + 2.5V, V _{RIPPLE} = 1V _{P-P} I _{LOAD} = 4A	60	80		dB
Thermal Regulation	AMS1508	T _A = 25°C, 30ms pulse		0.002	0.020	%W
Thermal Resistance Junction-to-Case		T Package: Control Circuitry/ Power Transistor			0.65/2.7	°C/W
		M Package: Control Circuitry/ Power Transistor			0.65/2.7	°C/W

ELECTRICAL CHARACTERISTICS

Electrical Characteristics at $I_{OUT} = 0 \text{ mA}$, and $T_J = +25^\circ\text{C}$ unless otherwise specified.

Parameter	Device	Conditions	Min	Typ	Max	Units
Dropout Voltage		Note 2				
Control Dropout ($V_{CONTROL} - V_{OUT}$)	AMS1508/-1.5/-2.5/ -2.85/-3.0/-3.3/-3.5/-5.0	$V_{POWER} = V_{OUT} + 0.8\text{V}$, $I_{LOAD} = 10\text{mA}$		1.00	1.15	V
		$V_{POWER} = V_{OUT} + 0.8\text{V}$, $I_{LOAD} = 8\text{A}$		1.15	1.30	V
Power Dropout ($V_{POWER} - V_{OUT}$)	AMS1508/-1.5/-2.5/ -2.85/-3.0/-3.3/-3.5/-5.0	$V_{CONTROL} = V_{OUT} + 2.5\text{V}$, $I_{LOAD} = 10\text{mA}$.10	0.17	V
		$V_{CONTROL} = V_{OUT} + 2.5\text{V}$, $I_{LOAD} = 8\text{A}$.45	0.50	V

Parameters identified with **boldface type** apply over the full operating temperature range.

Note 1: Absolute Maximum Ratings indicate limits beyond which damage to the device may occur. For guaranteed specifications and test conditions, see the Electrical Characteristics. The guaranteed specifications apply only for the test conditions listed.

Note 2: Unless otherwise specified $V_{OUT} = V_{SENSE}$. For the adjustable device $V_{ADJ} = 0\text{V}$.

Note 3: The dropout voltage for the AMS1508 is caused by either minimum control voltage or minimum power voltage. The specifications represent the minimum input/output voltage required to maintain 1% regulation.

Note 4: For the adjustable device the minimum load current is the minimum current required to maintain regulation. Normally the current in the resistor divider used to set the output voltage is selected to meet the minimum load current requirement.

Note 5: The control pin current is the drive current required for the output transistor. This current will track output current with a ratio of about 1:100. The minimum value is equal to the quiescent current of the device.

PIN FUNCTIONS

Sense (Pin 1): This pin is the positive side of the reference voltage for the device. With this pin it is possible to Kelvin sense the output voltage at the load.

Adjust (Pin 2): This pin is the negative side of the reference voltage for the device. Adding a small bypass capacitor from the Adjust pin to ground improves the transient response. For fixed voltage devices the Adjust pin is also brought out to allow the user to add a bypass capacitor.

GND (Pin 2): For fixed voltage devices this is the bottom of the resistor divider that sets the output voltage.

Output (Pin 3): This is the power output of the device.

$V_{CONTROL}$ (Pin 4): This pin is the supply pin for the control circuitry of the device. The current flow into this pin will be about 1% of the output current. The voltage at this pin must be 1.3V or greater than the output voltage for the device to regulate.

V_{POWER} (Pin 5): This pin is the collector to the power device of the AMS1508. The output load current is supplied through this pin. The voltage at this pin must be between 0.1V and 0.8V greater than the output voltage for the device to regulate.

APPLICATION HINTS

The AMS1508 series of adjustable and fixed regulators are designed to power the new generation of microprocessors. The AMS1508 is designed to make use of multiple power supplies, existing in most systems, to reduce the dropout voltage. One of the advantages of the two supply approach is maximizing the efficiency.

The second supply is at least 1V greater than output voltage and is providing the power for the control circuitry and supplies the drive current to the NPN output transistor. This allows the NPN to be driven into saturation; thereby reducing the dropout voltage by a VBE compared to conventional designs. For the control voltage the current requirement is small equal to about 1% of the output current or approximately 100mA for a 10A load. Most of this current is drive current for the NPN output transistor. This drive current becomes part of the output current. The maximum voltage on the Control pin is 13V. The maximum voltage at the Power pin is 7V. Ground pin current for fixed voltage devices is typical 6mA and is constant as a function of load. Adjust pin current for adjustable devices is 60µA at 25°C and varies proportional to absolute temperature.

The improved frequency compensation of AMS1508 permits the use of capacitors with very low ESR. This is critical in addressing the needs of modern, low voltage high speed microprocessors. The new generation of microprocessors cycle load current from several hundred mA to several A in tens of nanoseconds. Output voltage tolerances are tighter and include transient response as part of the specification. Designed to meet the fast current load step requirements of these microprocessors, the AMS1508 also saves total cost by needing less output capacitance to maintain regulation.

Careful design of the AMS1508 has eliminated any supply sequencing issues associated with a dual supply system. The output voltage will not turn on until both supplies are operating. If the control voltage comes up first, the output current will be limited to a few milliamperes until the power input voltage comes up. If power input comes up first the output will not turn on at all until the control voltage comes up. The output can never come up unregulated. By tying the control and power inputs together the AMS1508 can also be operated as a single supply device. In single supply operation the dropout will be determined by the minimum control voltage.

The new features of the AMS1508 require additional pins over the traditional 3-terminal regulator. Both the fixed and adjustable versions have remote sense pins, permitting very accurate regulation of output voltage at the load, rather than at the regulator. As a result, over an output current range of 100mA to 8A with a 2.5V output, the typical load regulation is less than 1mV. For the fixed voltages the adjust pin is brought out allowing the user to improve transient response by bypassing the internal resistor divider. Optimum transient response is provided using a capacitor in the range of 0.1µF to 1µF for bypassing the Adjust pin. The value chosen will depend on the amount of output capacitance in the system.

In addition to the enhancements mentioned, the reference accuracy has been improved by a factor of two with a guaranteed initial tolerance of ±0.6% at 25°C. This device can hold 1% accuracy over the full temperature range and load current range,

guaranteed, when combined with ratiometrically accurate internal divider resistors and operating with an input/output differential of well under 1V.

Typical applications for the AMS1508 include 3.3V to 2.5V conversion with a 5V control supply, 5V to 4.2V conversion with a 12V control supply or 5V to 3.6V conversion with a 12V control supply. Due to the innovative design of the AMS1508 it is easy to obtain dropout voltages of less than 0.5V at 6A along with excellent static and dynamic specifications. Capable of 8A of output current with a maximum dropout of 0.8V the AMS1508 also has a fast transient response that allows it to handle large current changes associated with the new generation of microprocessors. The device is fully protected against overcurrent and overtemperature conditions.

Grounding and Output Sensing

The AMS1508 allows true Kelvin sensing for both the high and low side of the load. As a result the voltage regulation at the load can be easily optimized. Voltage drops due to parasitic resistances between the regulator and the load can be placed inside the regulation loop of the AMS1508. The advantages of remote sensing are illustrated in figures 1 through 3.

Figure 1 shows the device connected as a conventional 3 terminal regulator with the Sense lead connected directly to the output of the device. R_p is the parasitic resistance of the connections between the device and the load. Typically the load is a microprocessor and R_p is made up of the PC traces and /or connector resistances (in the case of a modular regulator) between the regulator and the processor. Trace A of figure 3 illustrates the effect of R_p . Very small resistances cause significant load regulation steps.

Figure 2 shows the device connected to take advantage of the remote sense feature. The Sense pin and the top of the resistor divider are connected to the top of the load; the bottom of the resistor divider is connected to the bottom of the load. R_p is now connected inside the regulation loop of the AMS1508 and for reasonable values of R_p the load regulation at the load will be negligible. The effect on output regulation can be seen in trace B of figure 3.

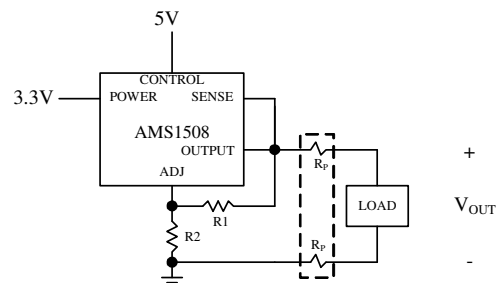

Figure 1. Conventional Load Sensing

APPLICATION HINTS

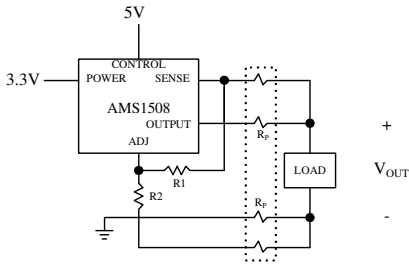

Figure 2. Remote Load Sensing

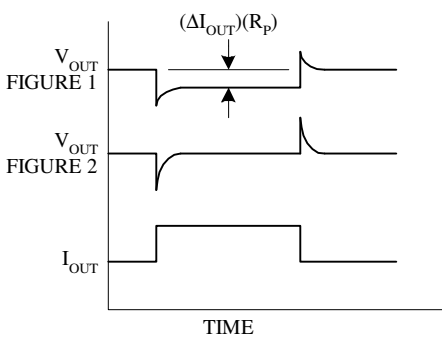

Figure 3. Remote Sensing Improves Load Regulation

Voltage drops due to R_p are not eliminated; they will add to the dropout voltage of the regulator regardless of whether they are inside or outside the regulation loop. The AMS1508 can control the voltage at the load as long as the input-output voltage is greater than the total of the dropout voltage of the device plus the voltage drop across R_p .

Stability

The circuit design used in the AMS1508 series requires the use of an output capacitor as part of the device frequency compensation. The addition of 150 μ F aluminum electrolytic or a 22 μ F solid tantalum on the output will ensure stability for all operating conditions. For best frequency response use capacitors with an ESR of less than 1 Ω .

In order to meet the transient requirements of the processor larger value capacitors are needed. Tight voltage tolerances are required in the power supply. To limit the high frequency noise generated by the processor high quality bypass capacitors must be used. In order to limit parasitic inductance (ESL) and resistance (ESR) in the capacitors to acceptable limits, multiple small ceramic capacitors in addition to high quality solid tantalum capacitors are required.

When the adjustment terminal is bypassed to improve the ripple rejection, the requirement for an output capacitor increases. The Adjust pin is brought out on the fixed voltage device specifically

to allow this capability. To ensure good transient response with heavy load current changes capacitor values on the order of 100 μ F are used in the output of many regulators. To further improve stability and transient response of these devices larger values of output capacitor can be used.

The modern processors generate large high frequency current transients. The load current step contains higher order frequency components than the output coupling network must handle until the regulator throttles to the load current level. Because they contain parasitic resistance and inductance, capacitors are not ideal elements. These parasitic elements dominate the change in output voltage at the beginning of a transient load step change. The ESR of the output capacitors produces an instantaneous step in output voltage ($\Delta V = \Delta I$)(ESR). The ESL of the output capacitors produces a droop proportional to the rate of change of the output current ($V = L$)($\Delta I / \Delta t$). The output capacitance produces a change in output voltage proportional to the time until the regulator can respond ($\Delta V = \Delta t$) ($\Delta I / C$). Figure 4 illustrates these transient effects.

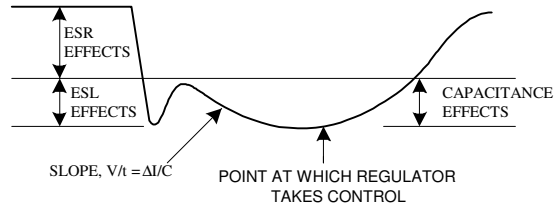
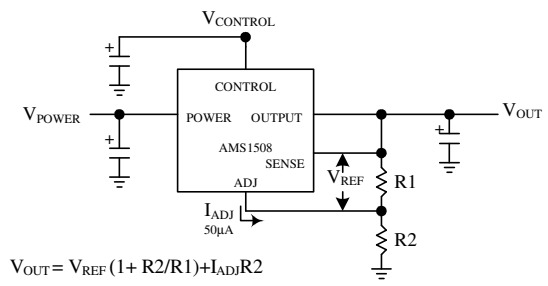

Figure 4.

Output Voltage

The AMS1508 series develops a 1.25V reference voltage between the Sense pin and the Adjust pin (Figure5). Placing a resistor between these two terminals causes a constant current to flow through R1 and down through R2 to set the overall output voltage. In general R1 is chosen so that this current is the specified minimum load current of 10mA. The current out of the Adjust pin is small, typically 50 μ A and it adds to the current from R1. Because I_{ADJ} is very small it needs to be considered only when very precise output voltage setting is required. For best regulation the top of the resistor divider should be connected directly to the Sense pin.



$$V_{OUT} = V_{REF} (1 + R2/R1) + I_{ADJ}R2$$

Figure 5. Setting Output Voltage

APPLICATION HINTS

Protection Diodes

Unlike older regulators, the AMS1508 family does not need any protection diodes between the adjustment pin and the output and from the output to the input to prevent die over-stress. Internal resistors are limiting the internal current paths on the AMS1508 adjustment pin, therefore even with bypass capacitors on the adjust pin no protection diode is needed to ensure device safety under short-circuit conditions. The Adjust pin can be driven on a transient basis $\pm 7V$ with respect to the output without any device degradation.

Diodes between the Output pin and V_{POWER} pin are not usually needed. Microsecond surge currents of 50A to 100A can be handled by the internal diode between the Output pin and V_{POWER} pin of the device. In normal operations it is difficult to get those values of surge currents even with the use of large output capacitances. If high value output capacitors are used, such as 1000 μF to 5000 μF and the V_{POWER} pin is instantaneously shorted to ground, damage can occur. A diode from output to input is recommended, when a crowbar circuit at the input of the AMS1508 is used (Figure 6). Normal power supply cycling or even plugging and unplugging in the system will not generate current large enough to do any damage.

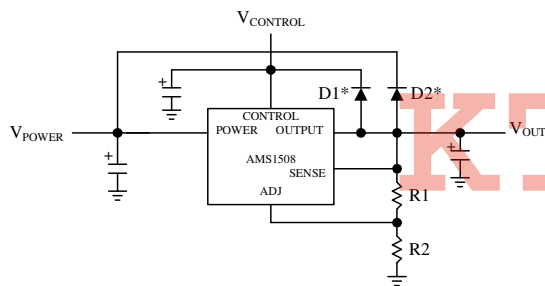

Figure 6. Optional Clamp Diodes Protect Against Input Crowbar Circuits

If the AMS1508 is connected as a single supply device with the control and power input pins shorted together the internal diode between the output and the power input pin will protect the control input pin. As with any IC regulator, none the protection circuitry will be functional and the internal transistors will break down if the maximum input to output voltage differential is exceeded.

Thermal Considerations

The AMS1508 series have internal power and thermal limiting circuitry designed to protect the device under overload conditions. However maximum junction temperature ratings should not be exceeded under continuous normal load conditions. Careful consideration must be given to all sources of thermal resistance from junction to ambient, including junction-to-case, case-to-heat sink interface and heat sink resistance itself.

Thermal resistance specification for both the Control Section and the Power Transistor are given in the electrical characteristics. The thermal resistance of the Control section is given as 0.65°C/W and junction temperature of the Control section can run up to 125°C. The thermal resistance of the Power section is given as 2.7°C/W and junction temperature of the Power section can run up to 150°C. Due to the thermal gradients between the power transistor and the control circuitry there is a significant difference in thermal resistance between the Control and Power sections.

Virtually all the power dissipated by the device is dissipated in the power transistor. The temperature rise in the power transistor will be greater than the temperature rise in the Control section making the thermal resistance lower in the Control section. At power levels below 12W the temperature gradient will be less than 25°C and the maximum ambient temperature will be determined by the junction temperature of the Control section. This is due to the lower maximum junction temperature in the Control section. At power levels above 12W the temperature gradient will be greater than 25°C and the maximum ambient temperature will be determined by the Power section. In both cases the junction temperature is determined by the total power dissipated in the device. For most low dropout applications the power dissipation will be less than 12W.

The power in the device is made up of two components: the power in the output transistor and the power in the drive circuit. The power in the control circuit is negligible.

The power in the drive circuit is equal to:

$$P_{DRIVE} = (V_{CONTROL} - V_{OUT})(I_{CONTROL})$$

Where $I_{CONTROL}$ is equal to between $I_{OUT}/100$ (typ) and $I_{OUT}/58$ (max).

The power in the output transistor is equal to:

$$P_{OUTPUT} = (V_{POWER} - V_{OUT})(I_{OUT})$$

The total power is equal to:

$$P_{TOTAL} = P_{DRIVE} + P_{OUTPUT}$$

Junction-to-case thermal resistance is specified from the IC junction to the bottom of the case directly below the die. This is the lowest resistance path for the heat flow. In order to ensure the best possible thermal flow from this area of the package to the heat sink proper mounting is required. Thermal compound at the case-to-heat sink interface is recommended. A thermally conductive spacer can be used, if the case of the device must be electrically isolated, but its added contribution to thermal resistance has to be considered.

TYPICAL PERFORMANCE CHARACTERISTICS

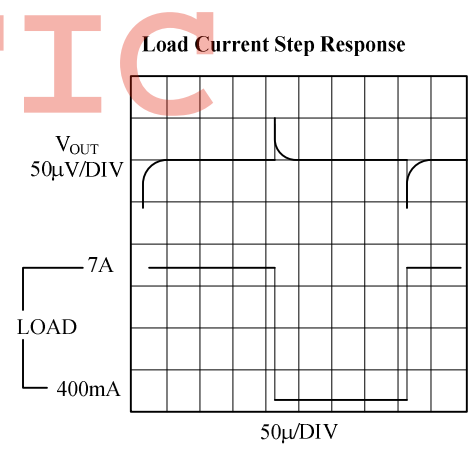
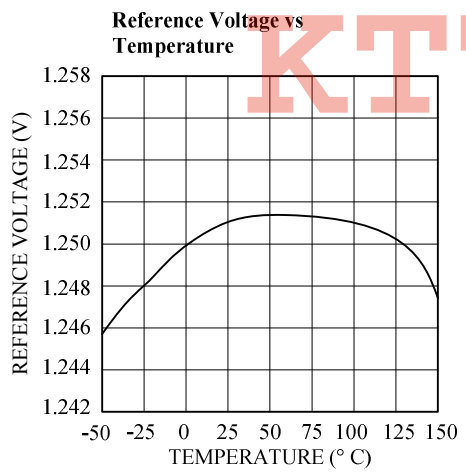
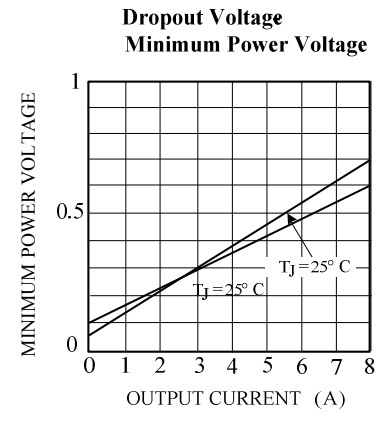
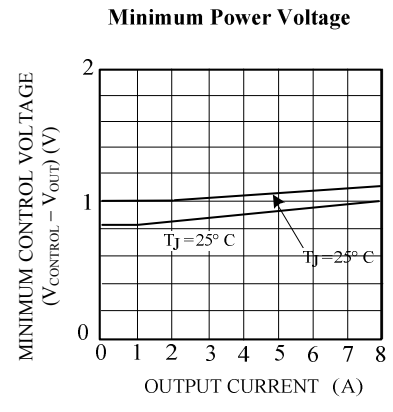
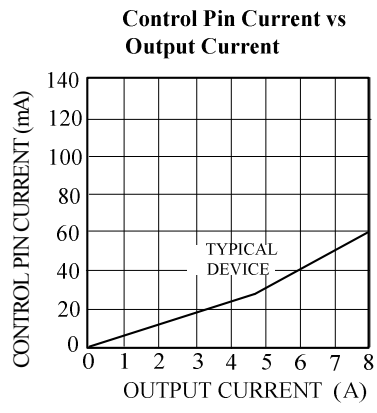

PACKAGE DIMENSIONS inches (millimeters) unless otherwise noted.

5 LEAD TO-220 PLASTIC PACKAGE (T)

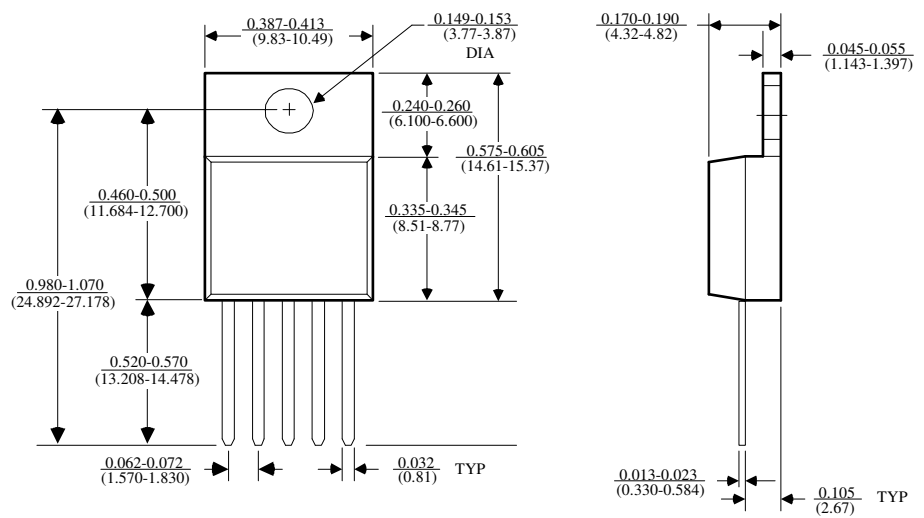

T (TO-220) AMS DRW# 042194



5 LEAD TO-263 PLASTIC PACKAGE (M)

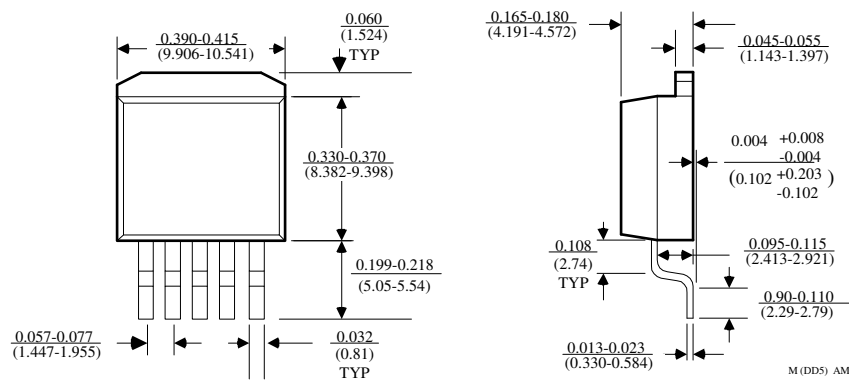

M (DDS) AMS DRW#042192R1