

# Advanced Monolithic Systems

# AMS1084

## 5A LOW DROPOUT VOLTAGE REGULATOR

RoHS compliant

### FEATURES

- Three Terminal Adjustable or Fixed 1.5V, 2.5V, 2.85V, 3.0V, 3.3V, 3.5V and 5.0V
- Output Current of 5A
- Operates Down to 1V Dropout
- Line Regulation: 0.015%
- Load Regulation: 0.1%
- TO-220 and TO-263 packages available

### APPLICATIONS

- High Efficiency Linear Regulators
- Post Regulators for Switching Supplies
- Microprocessor Supply
- Battery Chargers
- Constant Current Regulators
- Notebook/Personal Computer Supplies
- Portable Instrumentation

### GENERAL DESCRIPTION

The AMS1084 series of adjustable and fixed voltage regulators are designed to provide 5A output current and to operate down to 1V input-to-output differential. The dropout voltage of the device is guaranteed maximum 1.5V at maximum output current, decreasing at lower load currents.

On-chip trimming adjusts the reference voltage to 1%. Current limit is also trimmed, minimizing the stress under overload conditions on both the regulator and power source circuitry.

The AMS1084 devices are pin compatible with older three-terminal regulators and are offered in 3 lead TO-220 package and 3 and 2 lead TO-263 (Plastic DD).



### ORDERING INFORMATION:

PACKAGE TYPE		OPERATING JUNCTION
3 LEAD TO-220	2&3 LEAD TO-263	TEMPERATURE RANGE
AMS1084CT	AMS1084CM	0 to 125° C
AMS1084CT-1.5	AMS1084CM-1.5	0 to 125° C
AMS1084CT-2.5	AMS1084CM-2.5	0 to 125° C
AMS1084CT-2.85	AMS1084CM-2.85	0 to 125° C
AMS1084CT-3.0	AMS1084CM-3.0	0 to 125° C
AMS1084CT-3.3	AMS1084CM-3.3	0 to 125° C
AMS1084CT-3.5	AMS1084CM-3.5	0 to 125° C
AMS1084CT-5.0	AMS1084CM-5.0	0 to 125° C

### PIN CONNECTIONS

#### FIXED VERSION

- 1- Ground
- 2-  $V_{OUT}$
- 3-  $V_{IN}$

#### ADJUSTABLE VERSION

- 1- Adjust
- 2-  $V_{OUT}$
- 3-  $V_{IN}$

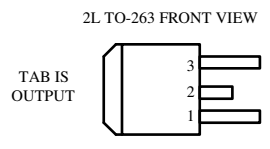
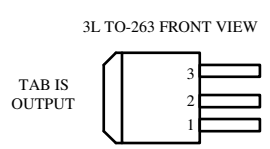
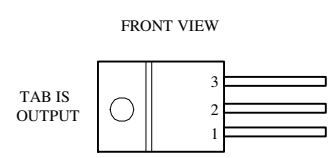

**ABSOLUTE MAXIMUM RATINGS** (Note 1)

Power Dissipation	Internally limited
Input Voltage	15V
Operating Junction Temperature Range	
Control Section	0°C to 125°C
Power Transistor	0°C to 150°C
Storage temperature	- 65°C to +150°C

Soldering information

Lead Temperature (25 sec)	265°C
Thermal Resistance	
TO-220 package	$\phi_{JA} = 50^{\circ}\text{C/W}$
TO-263 package	$\phi_{JA} = 30^{\circ}\text{C/W} *$

\* With package soldering to 0.5in<sup>2</sup> copper area over backside ground plane or internal power plane  $\phi_{JA}$  can vary from 20°C/W to >40°C/W depending on mounting technique.

**ELECTRICAL CHARACTERISTICS**

Electrical Characteristics at  $I_{OUT} = 0 \text{ mA}$ , and  $T_J = +25^{\circ}\text{C}$  unless otherwise specified.

Parameter	Device	Conditions	Min	Typ	Max	Units
Reference Voltage (Note 2)	AMS1084	$I_{OUT} = 10 \text{ mA}$ $10\text{mA} \leq I_{OUT} \leq 5\text{A}$ , $1.5\text{V} \leq (V_{IN} - V_{OUT}) \leq 12\text{V}$	1.238	1.250	1.262	V
			<b>1.225</b>	<b>1.250</b>	<b>1.270</b>	V
Output Voltage (Note 2)	AMS1084-1.5	$0 \leq I_{OUT} \leq 5\text{A}$ , $3\text{V} \leq V_{IN} \leq 12\text{V}$	1.485	1.500	1.515	V
			<b>1.470</b>	<b>1.500</b>	<b>1.530</b>	V
	AMS1084-2.5	$0 \leq I_{OUT} \leq 5\text{A}$ , $4\text{V} \leq V_{IN} \leq 12\text{V}$	2.475	2.500	2.525	V
			<b>2.450</b>	<b>2.500</b>	<b>2.550</b>	V
	AMS1084-2.85	$0 \leq I_{OUT} \leq 5\text{A}$ , $4.35\text{V} \leq V_{IN} \leq 12\text{V}$	2.82	2.850	2.88	V
			<b>2.79</b>	<b>2.850</b>	<b>2.91</b>	V
	AMS1084-3.0	$0 \leq I_{OUT} \leq 5\text{A}$ , $4.5\text{V} \leq V_{IN} \leq 12\text{V}$	2.970	3.000	3.300	V
			<b>2.940</b>	<b>3.000</b>	<b>3.360</b>	V
	AMS1084-3.3	$0 \leq I_{OUT} \leq 5\text{A}$ , $4.75\text{V} \leq V_{IN} \leq 12\text{V}$	3.267	3.300	3.333	V
			<b>3.235</b>	<b>3.300</b>	<b>3.365</b>	V
	AMS1084-3.5	$0 \leq I_{OUT} \leq 5\text{A}$ , $5\text{V} \leq V_{IN} \leq 12\text{V}$	3.465	3.500	3.535	V
			<b>3.430</b>	<b>3.500</b>	<b>3.570</b>	V
	AMS1084-5.0	$0 \leq I_{OUT} \leq 5\text{A}$ , $6.5\text{V} \leq V_{IN} \leq 12\text{V}$	4.950	5.000	5.050	V
			<b>4.900</b>	<b>5.000</b>	<b>5.100</b>	V
Line Regulation	AMS1084/-1.5/-2.5/-2.85/-3.0/-3.3/-3.5/-5.0	$I_{LOAD} = 10 \text{ mA}$ , $1.5\text{V} \leq (V_{IN} - V_{OUT}) \leq 12\text{V}$		0.3	6	mV
				<b>0.6</b>	<b>10</b>	mV
Load Regulation (Notes 2, 3)	AMS1084	$(V_{IN} - V_{OUT}) = 3\text{V}$ , $10\text{mA} \leq I_{OUT} \leq 5\text{A}$		0.1	0.3	%
				<b>0.2</b>	<b>0.4</b>	%
	AMS1084-1.5	$V_{IN} = 5\text{V}$ , $0 \leq I_{OUT} \leq 5\text{A}$		3	12	mV
				<b>6</b>	<b>20</b>	mV
	AMS1084-2.5	$V_{IN} = 5\text{V}$ , $0 \leq I_{OUT} \leq 5\text{A}$		3	12	mV
				<b>6</b>	<b>20</b>	mV
	AMS1084-2.85	$V_{IN} = 5\text{V}$ , $0 \leq I_{OUT} \leq 5\text{A}$		3	12	mV
				<b>6</b>	<b>20</b>	mV
	AMS1084-3.0	$V_{IN} = 5\text{V}$ , $0 \leq I_{OUT} \leq 5\text{A}$		3	12	mV
				<b>6</b>	<b>20</b>	mV
	AMS1084-3.3	$V_{IN} = 5\text{V}$ , $0 \leq I_{OUT} \leq 5\text{A}$		3	15	mV
				<b>7</b>	<b>25</b>	mV
	AMS1084-3.5	$V_{IN} = 5.25\text{V}$ , $0 \leq I_{OUT} \leq 5\text{A}$		3	15	mV
				<b>6</b>	<b>25</b>	mV
	AMS1084-5.0	$V_{IN} = 8\text{V}$ , $0 \leq I_{OUT} \leq 5\text{A}$		5	20	mV
				<b>10</b>	<b>35</b>	mV
Dropout Voltage ( $V_{IN} - V_{OUT}$ )	AMS1084/-1.5/-2.5/-2.85/-3.0/-3.3/-3.5/-5.0	$\Delta V_{OUT}$ , $\Delta V_{REF} = 1\%$ , $I_{OUT} = 5 \text{ A}$ (Note 4)		<b>1.3</b>	<b>1.5</b>	V

**ELECTRICAL CHARACTERISTICS**

Electrical Characteristics at  $I_{OUT} = 0$  mA, and  $T_J = +25^\circ\text{C}$  unless otherwise specified.

Parameter	Device	Conditions	Min	Typ	Max	Units
Current Limit	AMS1084/-1.5/-2.5/-2.85/-3.0/-3.3/-3.5/-5.0	$(V_{IN} - V_{OUT}) = 5V$	<b>5.00</b>	<b>6.00</b>	<b>7.00</b>	A
Minimum Load Current	AMS1084	$(V_{IN} - V_{OUT}) = 12V$ (Note 5)		<b>5</b>	<b>10</b>	mA
Quiescent Current	AMS1084/-1.5/-2.5/-2.85/-3.0/-3.3/-3.5/-5.0	$V_{IN} \leq 12V$		<b>5</b>	<b>10</b>	mA
Ripple Rejection	AMS1084	$f = 120\text{Hz}$ , $C_{OUT} = 25\mu\text{F}$ Tantalum, $I_{OUT} = 5A$ , $(V_{IN} - V_{OUT}) = 3V$ , $C_{ADJ} = 25\mu\text{F}$	<b>60</b>	<b>75</b>		dB
	AMS1084-1.5	$f = 120\text{Hz}$ , $C_{OUT} = 25\mu\text{F}$ Tantalum, $I_{OUT} = 5A$ , $V_{IN} = 4.5V$	<b>60</b>	<b>72</b>		dB
	AMS1084-2.5	$f = 120\text{Hz}$ , $C_{OUT} = 25\mu\text{F}$ Tantalum, $I_{OUT} = 5A$ , $V_{IN} = 5.5V$	<b>60</b>	<b>72</b>		dB
	AMS1084-2.85	$f = 120\text{Hz}$ , $C_{OUT} = 25\mu\text{F}$ Tantalum, $I_{OUT} = 5A$ , $V_{IN} = 6V$	<b>60</b>	<b>72</b>		dB
	AMS1084-3.0	$f = 120\text{Hz}$ , $C_{OUT} = 25\mu\text{F}$ Tantalum, $I_{OUT} = 5A$ , $V_{IN} = 6V$	<b>60</b>	<b>72</b>		dB
	AMS1084-3.3	$f = 120\text{Hz}$ , $C_{OUT} = 25\mu\text{F}$ Tantalum, $I_{OUT} = 5A$ , $V_{IN} = 6.3V$	<b>60</b>	<b>72</b>		dB
	AMS1084-3.5	$f = 120\text{Hz}$ , $C_{OUT} = 25\mu\text{F}$ Tantalum, $I_{OUT} = 5A$ , $V_{IN} = 6.5V$	<b>60</b>	<b>72</b>		dB
	AMS1084-5.0	$f = 120\text{Hz}$ , $C_{OUT} = 25\mu\text{F}$ Tantalum, $I_{OUT} = 5A$ , $V_{IN} = 8V$	<b>60</b>	<b>68</b>		dB
Thermal Regulation	AMS1084	$T_A = 25^\circ\text{C}$ , 30ms pulse		0.008	0.04	%W
Adjust Pin Current	AMS1084	$10\text{mA} \leq I_{OUT} \leq 5A$ , $1.5V \leq (V_{IN} - V_{OUT}) \leq 12V$		55	<b>120</b>	$\mu\text{A}$ $\mu\text{A}$
Adjust Pin Current Change	AMS1084	$10\text{mA} \leq I_{OUT} \leq 5A$ , $1.5V \leq (V_{IN} - V_{OUT}) \leq 12V$		<b>0.2</b>	<b>5</b>	$\mu\text{A}$
Temperature Stability				<b>0.5</b>		%
Long Term Stability		$T_A = 125^\circ\text{C}$ , 1000Hrs		0.3	1	%
RMS Output Noise (% of $V_{OUT}$ )		$T_A = 25^\circ\text{C}$ , $10\text{Hz} \leq f \leq 10\text{kHz}$		0.003		%
Thermal Resistance Junction-to-Case		M Package: Control Circuitry/ Power Transistor T Package: Control Circuitry/ Power Transistor			1.5/4.0 1.5/4.0	$^\circ\text{C/W}$ $^\circ\text{C/W}$

Parameters identified with **boldface type** apply over the full operating temperature range.

**Note 1:** Absolute Maximum Ratings indicate limits beyond which damage to the device may occur. For guaranteed specifications and test conditions, see the Electrical Characteristics. The guaranteed specifications apply only for the test conditions listed.

**Note 2:** Line and Load regulation are guaranteed up to the maximum power dissipation of 15W. Power dissipation is determined by the input/output differential and the output current. Guaranteed maximum power dissipation will not be available over the full input/output range.

**Note 3:** See thermal regulation specifications for changes in output voltage due to heating effects. Line and load regulation are measured at a constant junction temperature by low duty cycle pulse testing. Load regulation is measured at the output lead ~1/8" from the package.

**Note 4:** Dropout voltage is specified over the full output current range of the device.

**Note 5:** Minimum load current is defined as the minimum output current required to maintain regulation. When  $(V_{IN} - V_{OUT}) = 12V$  the device is guaranteed to regulate if the output current is greater than 10mA.

## APPLICATION HINTS

The AMS1084 series of adjustable and fixed regulators are easy to use and have all the protection features expected in high performance voltage regulators: short circuit protection and thermal shut-down.

Pin compatible with older three terminal adjustable regulators, these devices offer the advantage of a lower dropout voltage, more precise reference tolerance and improved reference stability with temperature.

### Stability

The circuit design used in the AMS1084 series requires the use of an output capacitor as part of the device frequency compensation. The addition of 150µF aluminum electrolytic or a 22µF solid tantalum on the output will ensure stability for all operating conditions.

When the adjustment terminal is bypassed with a capacitor to improve the ripple rejection, the requirement for an output capacitor increases. The value of 22µF tantalum or 150µF aluminum covers all cases of bypassing the adjustment terminal. Without bypassing the adjustment terminal smaller capacitors can be used with equally good results.

To ensure good transient response with heavy load current changes capacitor values on the order of 100µF are used in the output of many regulators. To further improve stability and transient response of these devices larger values of output capacitor can be used.

### Protection Diodes

Unlike older regulators, the AMS1084 family does not need any protection diodes between the adjustment pin and the output and from the output to the input to prevent over-stressing the die. Internal resistors are limiting the internal current paths on the AMS1084 adjustment pin, therefore even with capacitors on the adjustment pin no protection diode is needed to ensure device safety under short-circuit conditions.

Diodes between the input and output are not usually needed. Microsecond surge currents of 50A to 100A can be handled by the internal diode between the input and output pins of the device. In normal operations it is difficult to get those values of surge currents even with the use of large output capacitances. If high value output capacitors are used, such as 1000µF to 5000µF and the input pin is instantaneously shorted to ground, damage can occur. A diode from output to input is recommended, when a crowbar circuit at the input of the AMS1084 is used. Normal power supply cycling or even plugging and unplugging in the system will not generate current large enough to do any damage. The adjustment pin can be driven on a transient basis ±25V, with respect to the output without any device degradation. As with any IC regulator, none the protection circuitry will be functional and the internal transistors will break down if the maximum input to output voltage differential is exceeded.

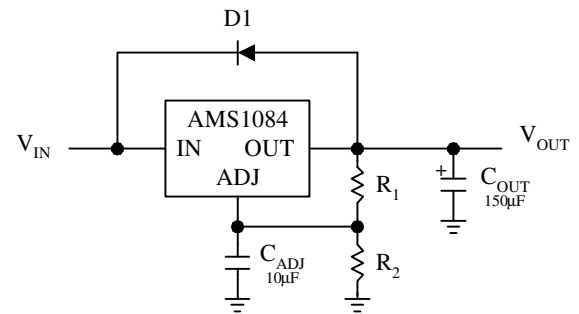

### Overload Recovery

When the power is first turned on, as the input voltage rises, the output follows the input, permitting the regulator to start up into heavy loads. During the start-up, as the input voltage is rising, the input-to-output voltage differential remains small, allowing the regulator to supply large output currents. A problem can occur with a heavy output load when the input voltage is high and the output voltage is low, when the removal of an output short will not permit the output voltage to recover. The load line for such a load may intersect two points on the output current curve. In this case, there are two stable output operating points for the regulator. With this double intersection, the power supply may need to be cycled down to zero and brought up again to make the output recover.

### Ripple Rejection

The ripple rejection values are measured with the adjustment pin bypassed. The impedance of the adjust pin capacitor at the ripple frequency should be less than the value of R1 (normally 100Ω to 120Ω) for a proper bypassing and ripple rejection approaching the values shown. The size of the required adjust pin capacitor is a function of the input ripple frequency. If R1=100Ω at 120Hz the adjust pin capacitor should be 25µF. At 10kHz only 0.22µF is needed.

The ripple rejection will be a function of output voltage, in circuits without an adjust pin bypass capacitor. The output ripple will increase directly as a ratio of the output voltage to the reference voltage ( $V_{OUT} / V_{REF}$ ).

### Output Voltage

The AMS1084 series develops a 1.25V reference voltage between the output and the adjust terminal. Placing a resistor between these two terminals causes a constant current to flow through R1 and down through R2 to set the overall output voltage.

**APPLICATION HINTS**

This current is normally the specified minimum load current of 10mA. Because  $I_{ADJ}$  is very small and constant it represents a small error and it can usually be ignored.

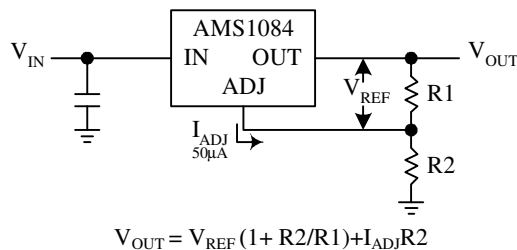

$$V_{OUT} = V_{REF} (1 + R2/R1) + I_{ADJ}R2$$

**Figure 1. Basic Adjustable Regulator**

**Load Regulation**

True remote load sensing it is not possible to provide, because the AMS1084 is a three terminal device. The resistance of the wire connecting the regulator to the load will limit the load regulation. The data sheet specification for load regulation is measured at the bottom of the package. Negative side sensing is a true Kelvin connection, with the bottom of the output divider returned to the negative side of the load.

The best load regulation is obtained when the top of the resistor divider R1 is connected directly to the case not to the load. If R1 were connected to the load, the effective resistance between the regulator and the load would be:

$$R_p \times \left( \frac{R_2 + R_1}{R_1} \right), \quad R_p = \text{Parasitic Line Resistance}$$

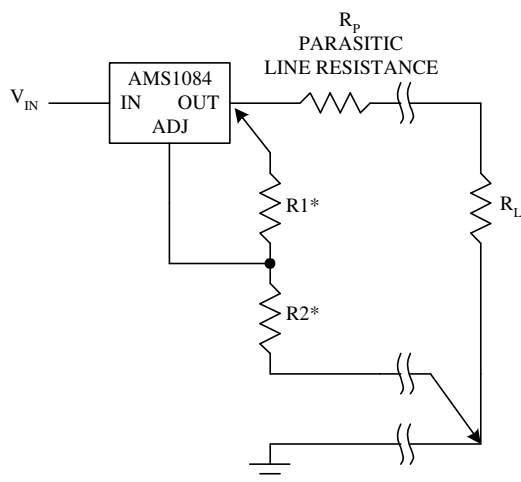

\*CONNECT R1 TO CASE  
CONNECT R2 TO LOAD

**Figure 2. Connections for Best Load Regulation**

Connected as shown,  $R_p$  is not multiplied by the divider ratio. Using 16-gauge wire the parasitic line resistance is about 0.004Ω per foot, translating to 4mV/ft at 1A load current. It is important to keep the positive lead between regulator and load as short as possible and use large wire or PC board traces.

**Thermal Considerations**

The AMS1084 series have internal power and thermal limiting circuitry designed to protect the device under overload conditions. However maximum junction temperature ratings should not be exceeded under continuous normal load conditions. Careful consideration must be given to all sources of thermal resistance from junction to ambient, including junction-to-case, case-to-heat sink interface and heat sink resistance itself. To ensure safe operating temperatures and reflect more accurately the device temperature, new thermal resistance specifications have been developed. Unlike older regulators with a single junction-to-case thermal resistance specification, the data section for these new regulators provides a separate thermal resistance and maximum junction temperature for both the Control Section and the Power Transistor. Calculations for both temperatures under certain conditions of ambient temperature and heat sink resistance and to ensure that both thermal limits are met.

Junction-to-case thermal resistance is specified from the IC junction to the bottom of the case directly below the die. This is the lowest resistance path for the heat flow. In order to ensure the best possible thermal flow from this area of the package to the heat sink proper mounting is required. Thermal compound at the case-to-heat sink interface is recommended. A thermally conductive spacer can be used, if the case of the device must be electrically isolated, but its added contribution to thermal resistance has to be considered.

TYPICAL PERFORMANCE CHARACTERISTICS

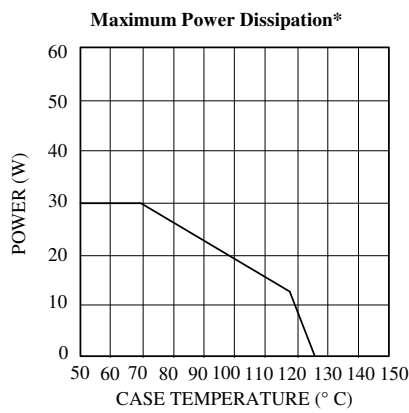
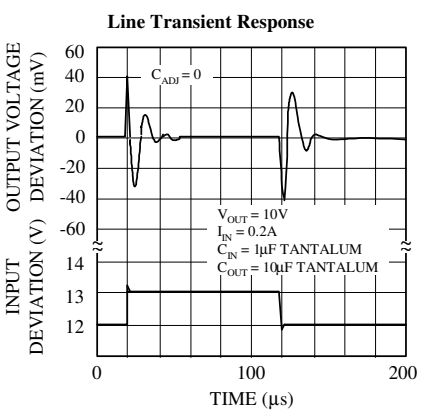
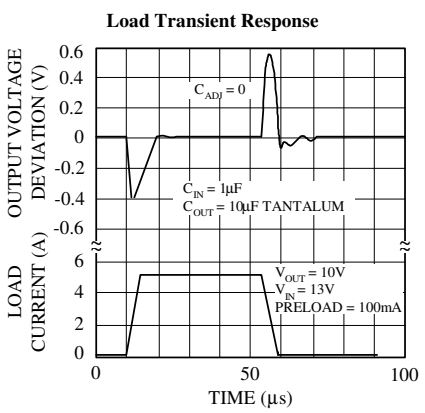
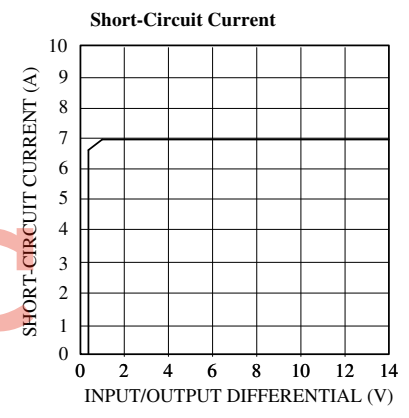
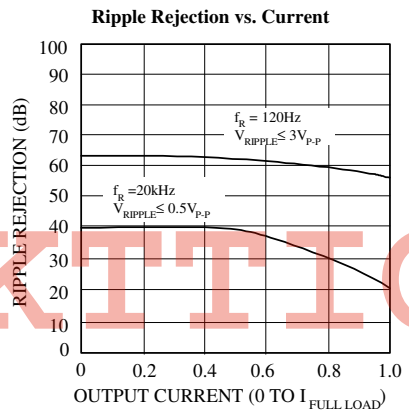
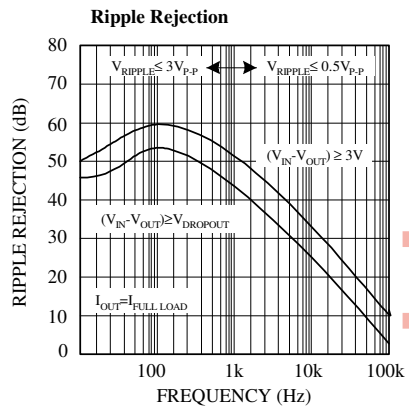
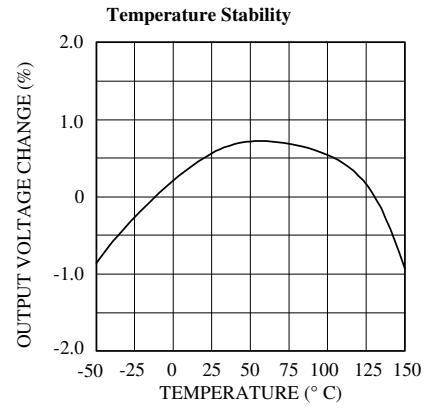
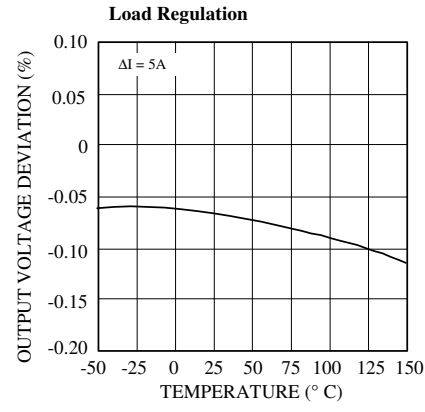
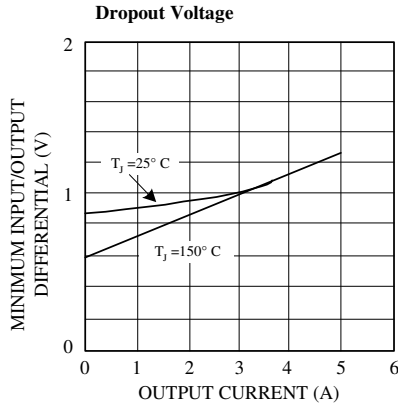

TYPICAL PERFORMANCE CHARACTERISTICS (Continued)

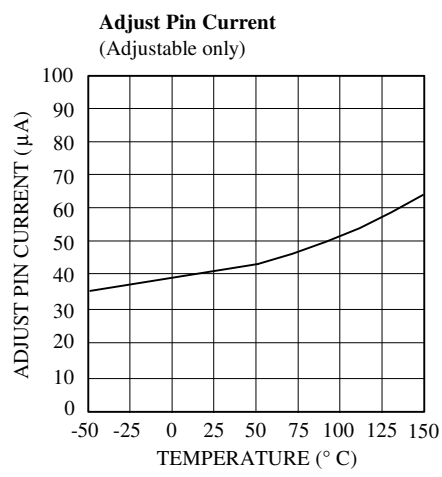
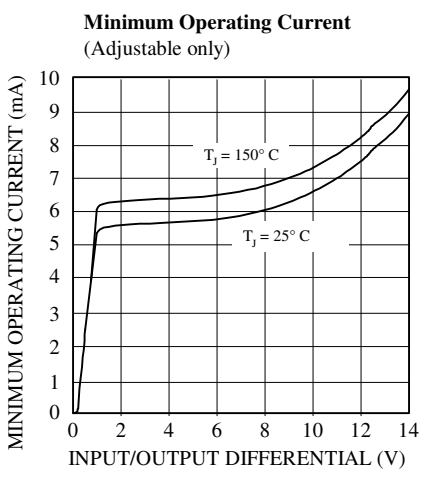

PACKAGE DIMENSIONS inches (millimeters) unless otherwise noted.

**KTTIC**  
3 LEAD TO-220 PLASTIC PACKAGE (T)

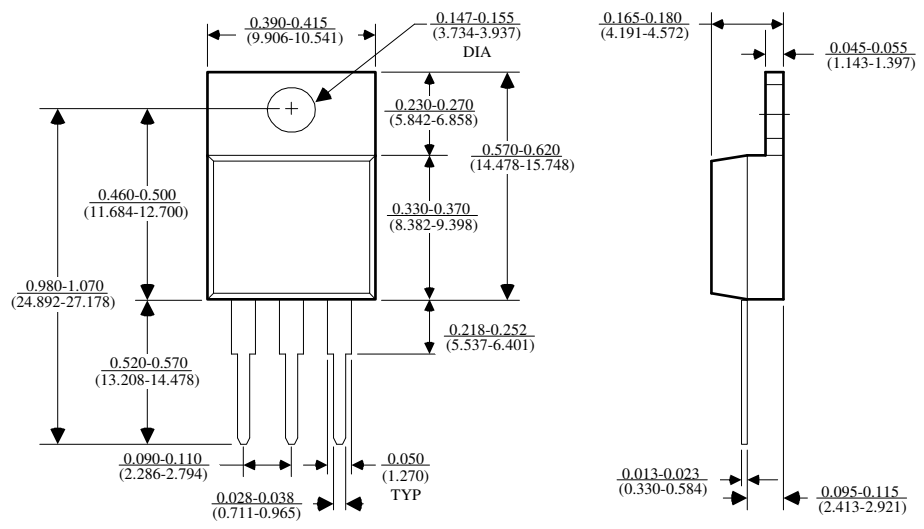

T (TO-220) AMS DRW# 042193

PACKAGE DIMENSIONS inches (millimeters) unless otherwise noted (Continued).

3 LEAD TO-263 PLASTIC DD (M)

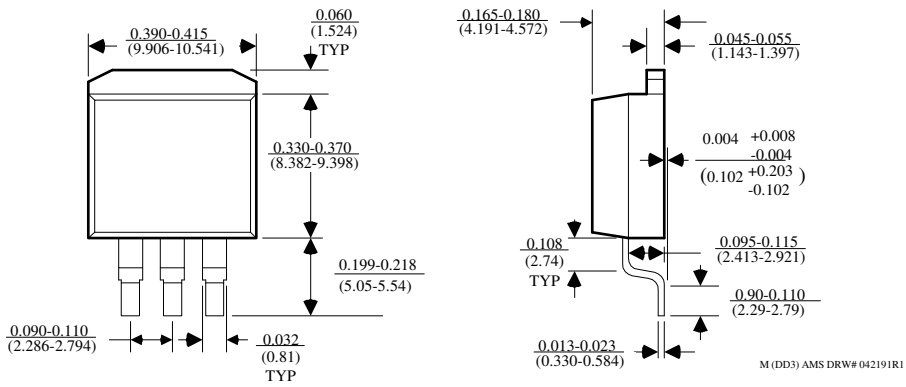

2 LEAD TO-263 PLASTIC DD (M)

